



DANOloft (B+)

- Pre-painted acoustical panels for screw-fixing
- Suitable as lining for walls and ceilings
- Installed on wood or steel (CD2 or P45-S25)
- No filling or painting required

CONDITIONS OF USE

- For internal fitout of buildings
- To be installed in a closed-off building

STORAGE

The products must be:

- stored indoors clean and dry
- positioned on a level base
- protected from direct moisture
- stored at humidities of less than 70% RH and temperatures of less than 50°C
- protected from impact and shock
- stacked max. 2 pallets on top of each other

Before installation, please ensure that fixtures to primary construction can withstand the load of the ceiling.
Best Practice: Use of clean cotton gloves when handling product tiles will ensure a good result and a ceiling without fingermarks.

PACKAGING OPENING

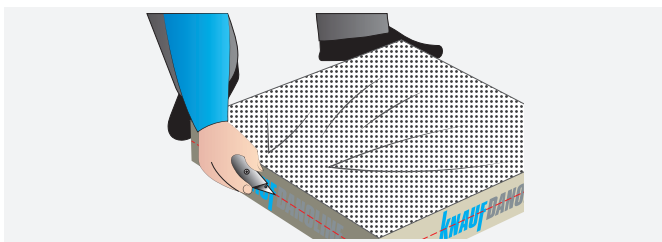

- Cut the plastic wrapping by running a knife along the sides of the package. Do not cut the plastic on top of the package.

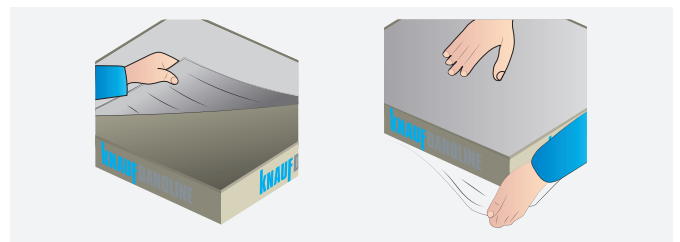

- Remove the plastic wrapping.

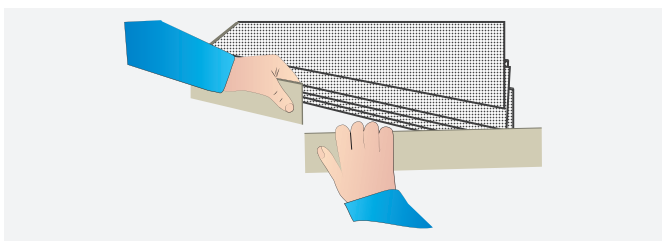









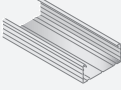

- Remove the cardboard liner around the ceiling tiles.

INSTALLATION GUIDE DANOlloft®

RECOMMENDED ACCESSORIES

Below accessories are tested and approved for use in connection with DANOlloft®.

	PRODUCT NAME	SAP NO.	SIZE	Consumption per m ²
	 DANOlloft® screw	0656651	4.5 x 25 (250 pcs. per box)	8 pcs. per panel (22.25 pcs per m ²)
	 Primary / secondary CD 60/27-profile	3294	60 x 4000 x 27	4.6 m
	 Wall angle UD 28/27	181589	28 x 3000 x 27	1.0*
	 Length connector CD 60/27	181080	59 x 80 x 28	1.1 pcs.
Accessories for CD system	 Cross-fitting	3446		3.3 pcs.
	 Split pin for hanger	198907		2.6 pcs.
	 Nonius hanger lower	198904		1.3 pcs.
	 Nonius hanger upper 85mm Nonius hanger upper 135mm Nonius hanger upper 235mm Nonius hanger upper 340mm Nonius hanger upper 440mm Nonius hanger upper 540mm Nonius hanger upper 640mm Nonius hanger upper 740mm Nonius hanger upper 840mm Nonius hanger upper 940mm	198905 198906 198923 198924 198925 198926 198927 198928 198929 198930	125 - 185 135 - 235 235 - 340 340 - 440 440 - 540 540 - 640 640 - 740 740 - 840 840 - 940 940 - 1040	1.3 pcs.
Accessories for P45-S25 system	 MSK 70 Perimeter profile	181029 181030	2500 3600	1.0 m*
	 P45 Primary profile	181684	3600	0.85 m
	 S25/85 Secondary profile	181685	3800	3.6 m
	 F/F13 Screw	2017	13	8 pcs.

CEILING LAYOUT FOR CD2 SYSTEM

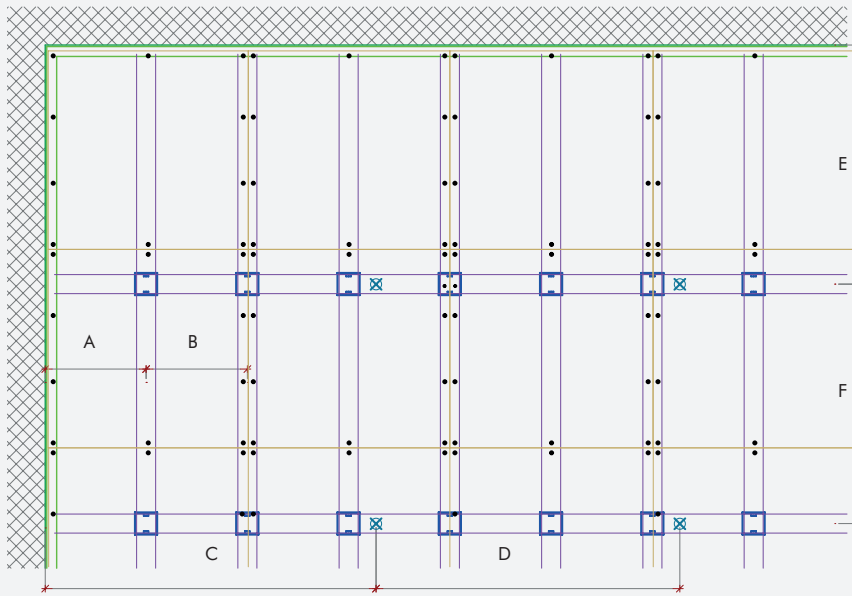

Legend:

- Wall profile UD 28/27
- CD profile 60/27
- Cross fitting
- ⊗ Nonius hanger (type depending on installation depth)

- A = Max. 300 mm
- B = Max. 300 mm
- C = Max. 900 mm
- D = Max. 900 mm
- E = Max. 900 mm
- F = Max. 900 mm
- G = Min. 80 mm
- H = Min. 80 mm

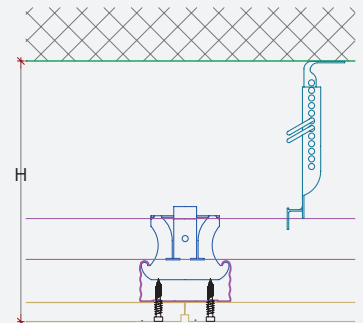
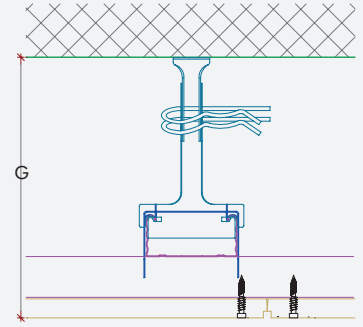

CEILING LAYOUT FOR P45-S25

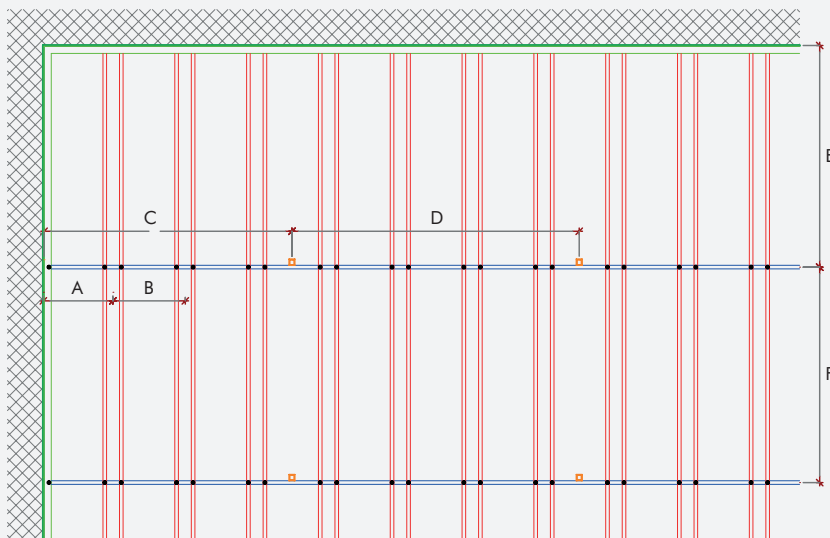

Legend:

- Primary profile P45
- Secondary profile S25/85
- Perimeter profile MSK 70
- Screw (F/F 13)
- Hanger (not Knauf Danoline)

- A = Max. 300 mm
- B = Max. 300 mm
- C = Max. 1200 mm
- D = Max. 1200 mm
- E = Max. 1200 mm
- F = Max. 1200 mm
- G = Min. 80 mm

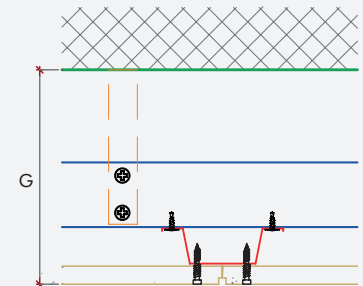
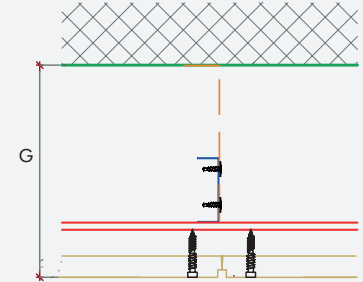

INSTALLATION GUIDE DANOloft® AS CELING LINING

INSTALLATION OF PANELS



INSTALLATION OF CD-PROFILES

- Install hangers pr. max. 900 mm.
- Suspend primary CD profiles pr. max. 900 mm.
- Attach secondary CD profiles pr. max. 300 mm.



INSTALLATION OF P45-S25 PROFILES

- Fix P45 primary profiles pr. max. 1000 mm.
- Attach S25/85 secondary profiles pr. max. 300 mm.

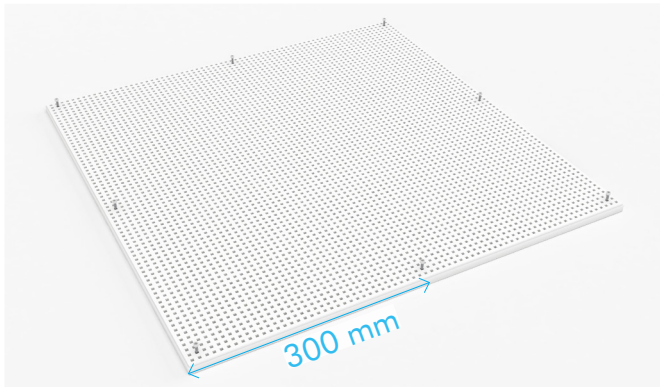

PLACING THE SCREWS

- Insert screws in 2nd perforation row (8 screws per panel).

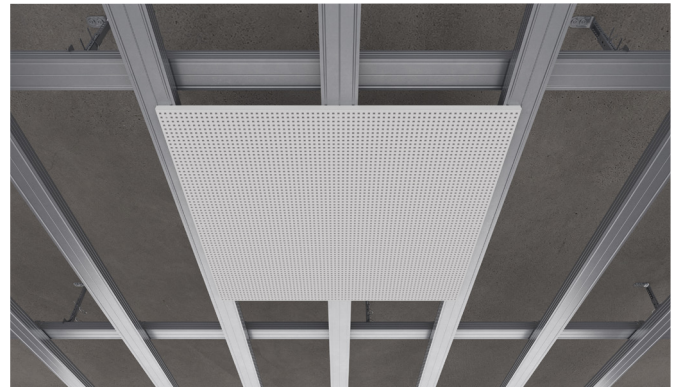

CEILING LAYOUT

- Place the panel in the centre of the ceiling surface. Hold the panel tight against the furring and install according to the layout. For installation pattern options, please go to page 11.
- Use a straightedge to set the direction.
- Start the installation by fixing 2 full rows of panels lengthwise to ensure correct direction of ceiling panels.

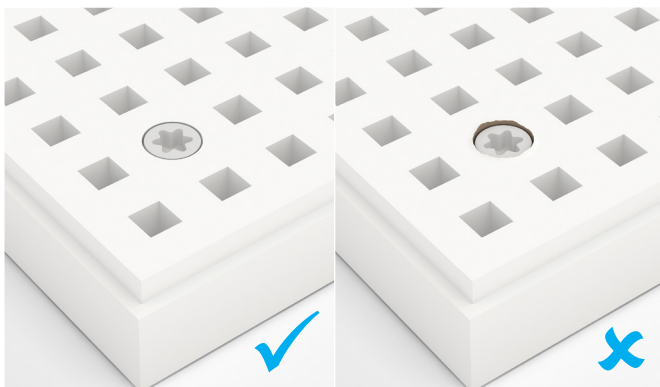

TIGHTENING OF SCREWS

- **IMPORTANT** – the head of the screw must be levelled with the surface of the panel. Use a cordless screw-driver and adjust the speed to **LOW**.

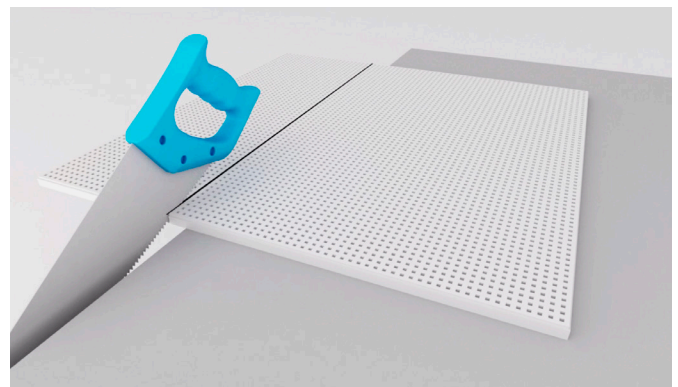

ADJUSTING PERIMETER

- Cut perimeter panels 2-3 mm shorter than the gap between the last full-size panel and the adjacent building component.
- Cut the elements from the front with a fine-toothed saw.
- Sand the edges with fine sand paper.

INSTALLATION GUIDE DANOloft® AS CELING LINING

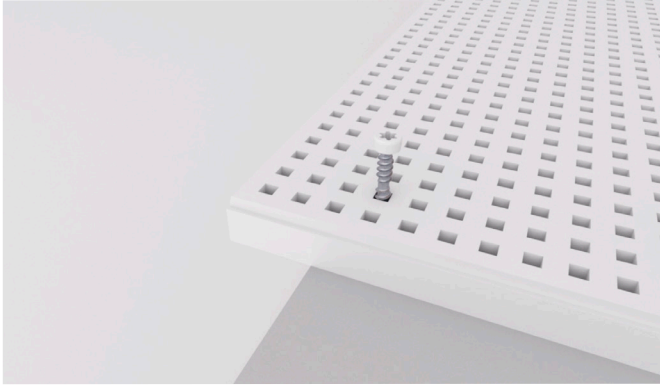

INSTALLATION OF ADJUSTED PANELS

- Place the screws in 4th or 5th perforation row of the adjusted panel for easier screw-fixing.



FINISHING AGAINST THE WALL

- Finish the surface using silicone sealant around the perimeter.

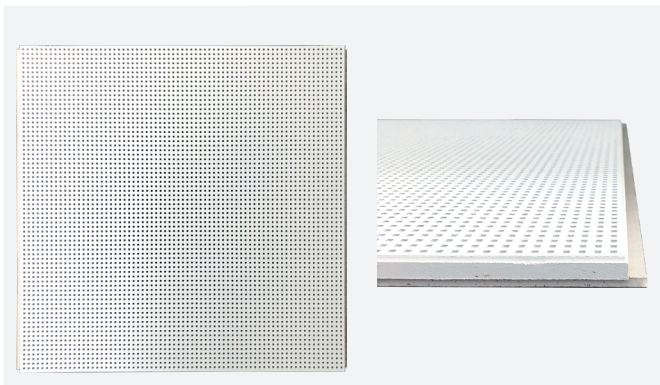

DANOLOFT® ACCESS PANEL

- DANOLOFT® access panel with a 6mm gypsumboard backing to support the DANOLOFT® panel. No fixing required. Access panel is demounted by pushing the panel and lifting it over the adjacent DANOLOFT® panels.

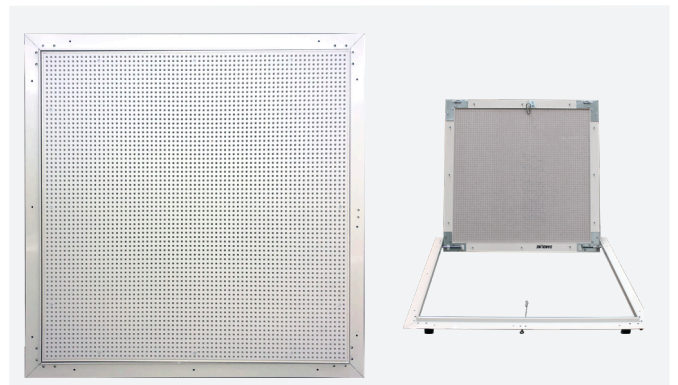

KNAUF DANOLINE ACCESS PANEL

- DANOLOFT® panel is framed and hinged into a steel profile of the Knauf Danoline access panel which is fixed in adjacent DANOLOFT® panels.

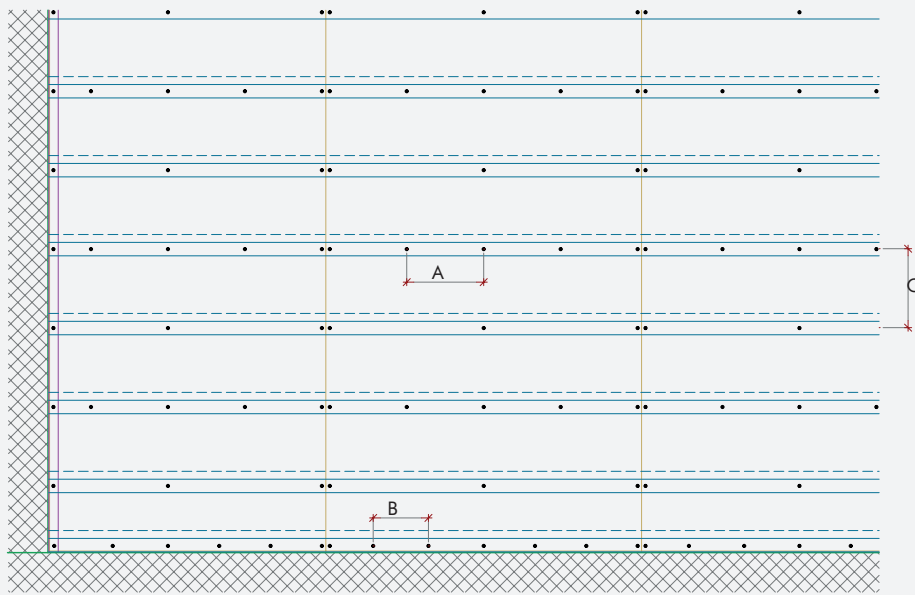

WALL LAYOUT

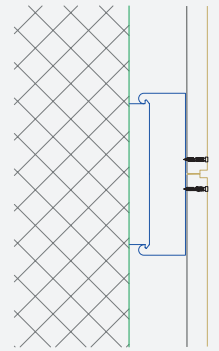

A = Max. 300 mm B = Max. 200 mm C = 300 mm

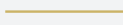

Legend:

-  45 mm Z-profile
-  45 mm U-profile
-  Screw SN 3.5 x 30
-  Panel edge

INSTALLATION OF PANELS

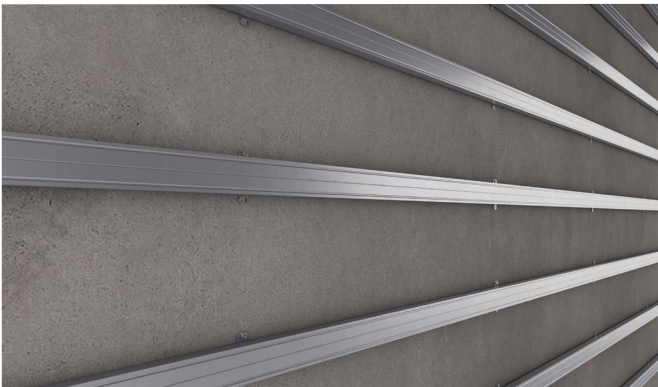

INSTALLATION OF CD-PROFILES

- Install UD profiles around the wall cladding area (top, bottom, and sides).
- Fix direct hangers to the wall pr. max. 900 mm.
- Install CD-profiles c/c 300 mm.

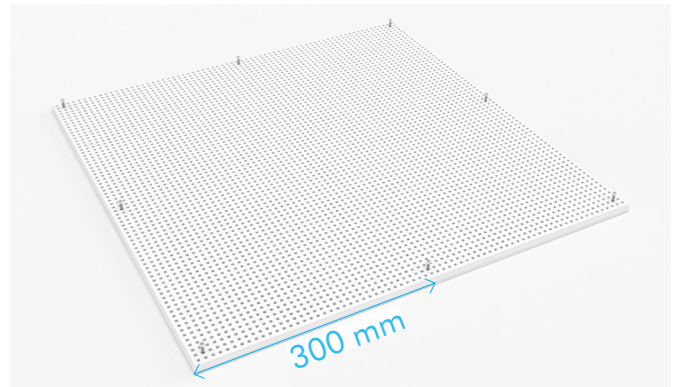

PLACING THE SCREWS

- Insert screws in 2nd perforation row (8 screws per panel).

INSTALLATION GUIDE DANOloft® AS WALL LINING

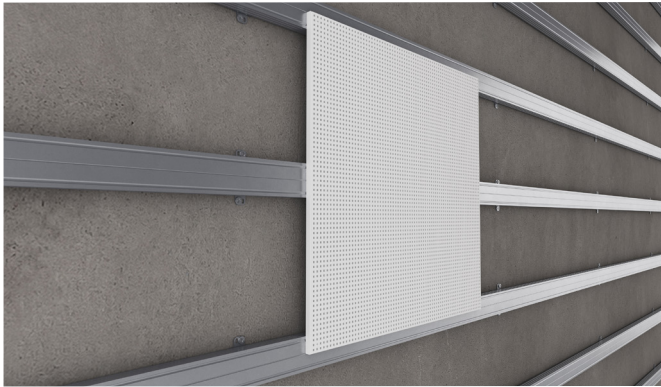

WALL LAYOUT

- Place the panel in the centre of the wall cladding area. Hold the panel tight against the furring and install according to the layout. For installation pattern options please see next page.
- Use a straightedge to set the direction.
- Start the installation by fixing 2 full rows of panels lengthwise to ensure the correct direction of the panels.
- 45 mm mineral wool backing is optional for maximising sound absorption.

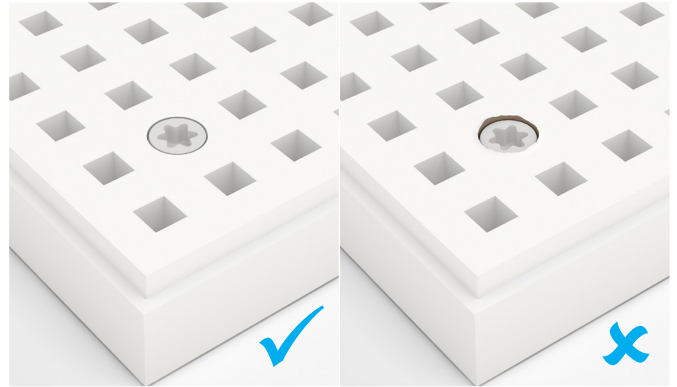

TIGHTENING OF SCREWS

- IMPORTANT – the head of the screw must be levelled with the surface of the panel. Use a cordless screw-driver and adjust the speed to LOW.

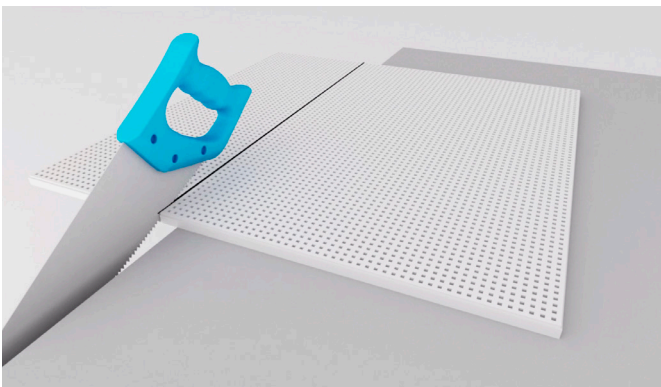

ADJUSTING PERIMETER

- Cut perimeter panels 2-3 mm shorter than the gap between the last full-size panel and the adjacent building component.
- Cut the elements from the front with a fine-toothed saw.
- Sand the edges with fine sand paper.