

U-Profile + DP12 A-Bar

Suspension system for concealed Clip-In solutions

Key features

- Suitable for square tile and rectangular panel layouts, tartan grid layouts (METAL K-Clip) and floating ceilings (METAL Sky Element Clip)
- Installed on the modular U-Profile primary grid system, with unique plug-in clip for quick and accurate installation
- Full range of accessories with multiple suspension options
- Brackets for swing-down functionality or clips for secure installations

Application areas

- From small service rooms to large commercial office buildings and major transportation terminals as well as clean rooms and *open plan offices (*METAL Sky Element Clip)

Systems

- METAL Q-Clip / METAL Q-Clip F / METAL S-Clip F / METAL R-Clip / METAL K-Clip / METAL Sky Element Clip / MESH R-Clip

U-Profile

& Accessories

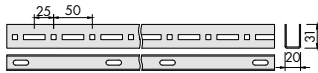

Item reference	Description	Dimensions (mm)	Material	Colour	Unit		Weight/ Unit kg
					pcs	lm	
M300100	U-Profile	3746 x 20 x 31	Galvanised steel	-	10	37.5	28.9
M300119	Splice connector for U-Profile	95 x 23 x 18	Galvanised steel	-	100	-	5.3
M300120	Plug-in clip for U-Profile	20 x 21 x 6	Spring steel	-	100	-	0.2
M300140	Wall anchor (except for METAL Sky Element Clip)	90 x 35 x 25	Galvanised steel	-	100	-	3.7
M311303	Hexagonal bolt M6 x 16 mm	M6 x 16	Galvanised steel	-	500	-	2.5
M311103	Hexagonal nut M6	M6 x 5	Galvanised steel	-	1000	-	3.0
M311305	Washer M6 18 x 1.6 mm	Ø18 x 1.6	Galvanised steel	-	200	-	0.6
M300121	Clamping bracket for U-Profile	43 x 37 x 20	Spring steel	-	100	-	2.3
M300366	Hanger for U-Profile	85 x 33 x 19	Galvanised steel	-	100	-	3.8
M300166	Combi-Nonius hanger for U-Profile	156 x 36 x 19	Galvanised steel	-	100	-	6.6

DP12 A-Bar & Accessories

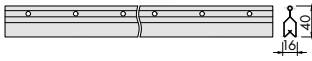

Item reference	Description	Dimensions (mm)	Material	Colour	Unit		Weight/ Unit kg
					pcs	lm	
M311022	DP12 A-Bar	3997 x 40 x 16	Galvanised steel	-	10	40	21.3
M300138	Connection-pin for DP12 A-Bar	60 x Ø 4.5	Galvanised steel	-	100	-	0.8
M311023	Splice connector for DP12 A-Bar	100 x 17 x 15	Galvanised steel	-	100	-	2.0
M300105	Hanger for DP12 A-Bar	52 x 20 x 4	Galvanised steel	-	100	-	0.6
M300155	Large hanger for DP12 A-Bar (optional)	100 x 20 x 4	Galvanised steel	-	100	-	0.7
M311028	Extraction tool (METAL Q-Clip, METAL Q-Clip F, METAL R-Clip, METAL K-Clip, METAL Sky Element Clip)	228 x 60 x 20	Stainless steel / plastic	-	1	-	0.1
M311046	Extraction tool (METAL S-Clip F, MESH R-Clip)	228 x 60 x 20	Stainless steel / plastic	-	1	-	0.1
M300106	Security clip (except for METAL S-Clip F)	54 x 40 x Ø2	Spring steel	-	100	-	0.2
M311027	Swing-down clip for WINDOW function	43 x 33 x 20	Spring steel	-	100	-	2.4
M300157	Security clip for WINDOW function	38 x 24 x 10	Spring steel	-	100	-	0.4
M300188	Swing-down clip for ACCESS function (DP12 A-Bar)	62 x 56 x Ø2.5	Spring steel	-	100	-	0.7
M311180	Nubby pliers (METAL Q-Clip, METAL Q-Clip F, METAL R-Clip, METAL R-Clip F, METAL K-Clip)	224	Steel / plastic	-	1	-	0.5

System Drawing

Extraction Tools

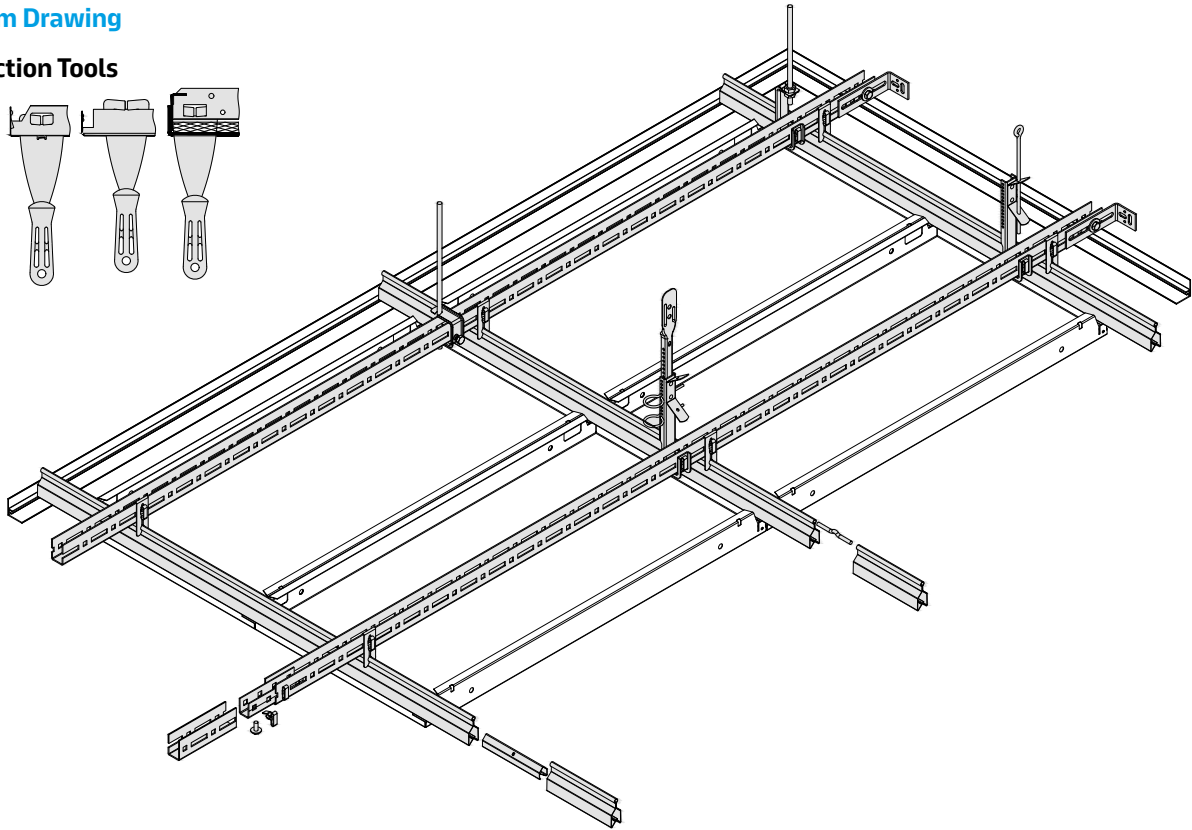
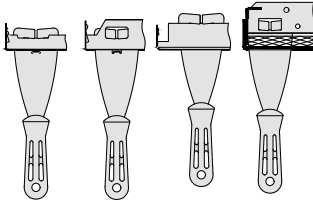

Hanger options

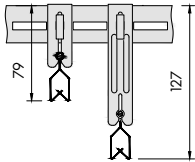

WINDOW function

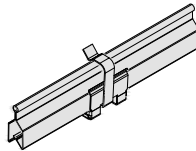

Security clip

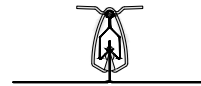

Characteristics	Detailed information	
Fire reaction		Euroclass A1 as per EN 13501-1
Indoor air quality		
Cleanability		
Sustainability		up to 25%

All measurements in millimetres. All sizes are nominal.
Cross Tee alignment is achieved by locating the tees to the left-hand side of the adjoining section.

Products may vary from country to country. Please contact your local sales representative.
For further information and legal notice, please visit our website.