

MINERAL SOLUTIONS

KNAUFCEILING
Solutions





Izkusite še
več inovacij

S FUNKCIONALNIMI, NARAVNIMI IN TRAJNOSTNIMI MINERALNIMI REŠITVAMI

Prepričani smo, da je strop sestavni del vsakega notranjega prostora. Daje nam čudovit občutek dobrega počutja in varnosti. Skladna povezava med oblikovanjem in funkcionalnostjo izboljšuje in varuje prostore, v katerih živimo, delamo, okrevamo in rastemo. Izboljšuje akustično udobje, zagotavlja zdrav zrak ter vpliva na našo koncentracijo in počutje.

Popoln prostor z našimi rešitvami na koncu ustvari naši kupci. Da bi jim pomagali uresničiti razburljivejšo vizijo, sta združila moči dva najbolj priznana svetovna proizvajalca stropov Armstrong Ceiling Solutions in Knauf AMF in ponudila najboljše od obeh v eni vodilni blagovni znamki – Knauf Ceiling Solutions.

Spektakularne projekte je mogoče uresničiti le, če je vzpostavljeno ravnotežje med funkcionalnostjo in dizajnom. Naš novi usklajeni portfelj Mineral Solutions kupcem omogoča brezmejen nabor različnih velikosti, oblik in izvedb robov v vseh sistemskih različicah.

Visokokakovostne mineralne plošče so izdelane s posebnim mokrim postopkom (wet-felt), pri katerem uporabljajo trajnostne surovine, vključno z biorazgradljivo mineralno volno, perlitom, glino in škrobom.

Z najboljšim iz obeh svetov in nadgradnjo dolgoletnih izkušenj postavlja Knauf Ceiling Solutions nove standarde za varnost, udobje, učinkovitost in zmogljivost. S pristopom izdelave plošč iz več različnih materialov vam zagotavljajo večjo izbiro, več navdih in več podpore ter tako omogočajo, da najdete edinstveno rešitev, ki je povsem v skladu z vašimi željami.

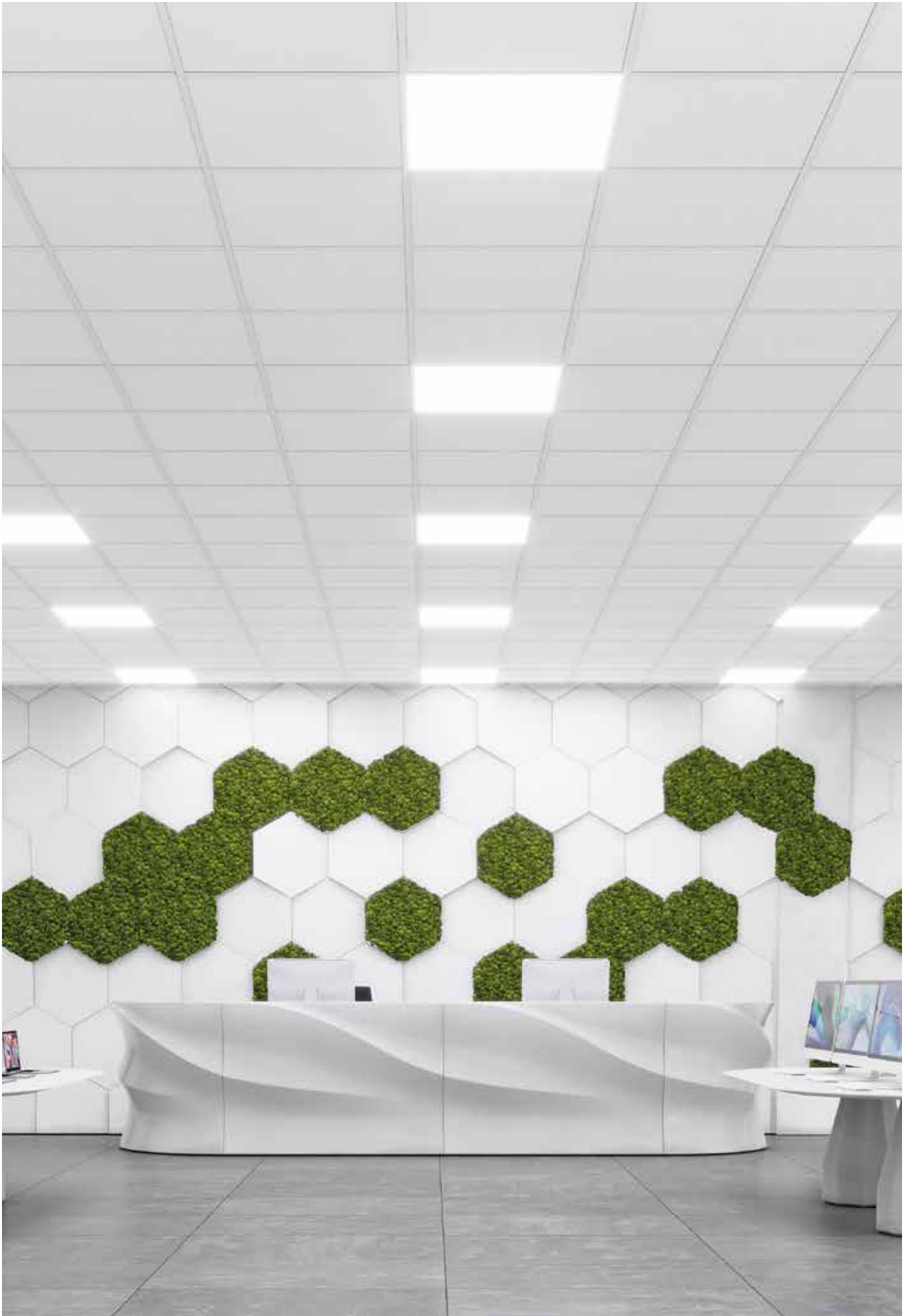

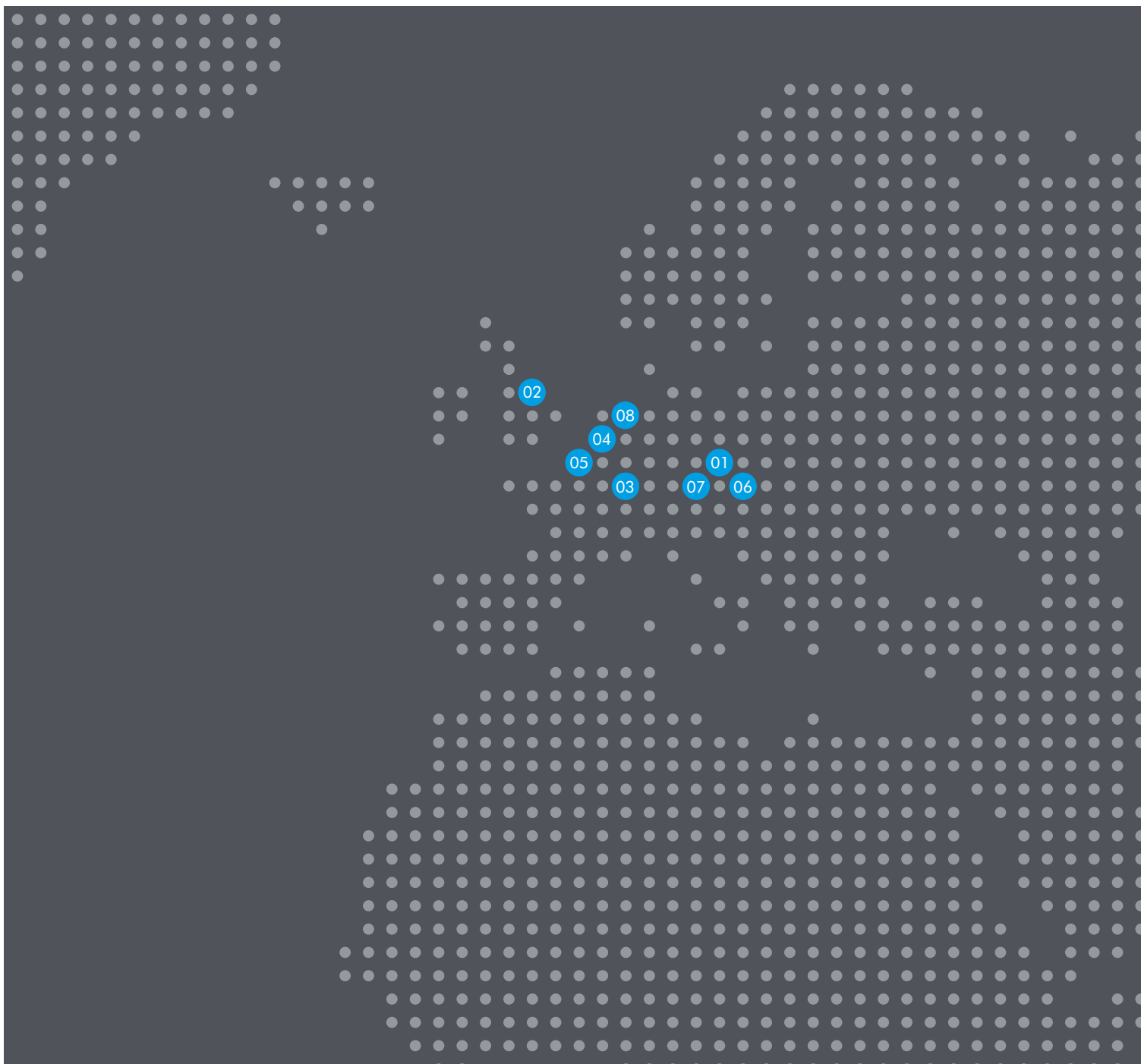

Proizvodna mreža

ODKRIJTE NAŠO VELIKO IN RAZNOLIKO MREŽO

Naša široka mreža, ki jo sestavlja trinajst najsodobnejših proizvodnih obratov v osmih državah v Evropi in Aziji, nam omogoča pravočasno zagotavljanje ponudbe visokokakovostnih stropnih rešitev. Da bi našim strankam zagotovili dosledno in zanesljivo dobavo, sledimo našim uveljavljenim proizvodnim vrednotam, ki izpolnjujejo najvišje svetovne standarde glede kakovosti, okolja in varnosti.



09

10

11



EMEA

- 01 Grafenau (DE)**
Mineralne plošče in
podkonstrukcija
- 02 Stafford (UK)**
Kovina
- 03 Pontarlier (FR)**
Mineralne plošče
- 04 Valenciennes (FR)**
Podkonstrukcija
- 05 Dreux (FR)**
Podkonstrukcija

- 06 Ferndorf (AT)**
Lesna volna
- 07 Rankweil (AT)**
Kovina
- 08 Antwerp (BE)**
Razrez



APAC

- 09 Wujiang (CN)**
Mineralne plošče
- 10 Shanghai (CN)**
Podkonstrukcija
- 11 Pune (IN)**
Podkonstrukcija

OPREDELITEV TEHNIČNIH SIMBOLOV



ABSORPCIJA ZVOKA

Ocena koeficienta vpijanja zvoka, izračunana v skladu z EN ISO 11654 (α_w) ali ASTM C 423 (NRC).



RAZRED ABSORPCIJE ZVOKA

Klasifikacija absorpcije zvoka (A–E) na osnovi vrednosti absorpcije zvoka α_w .



ZVOČNA IZOLIRNOST

Prenos zvoka po zraku (en prehod), izračunana v skladu z EN ISO 717-1.



VZDOLŽNO ZVOČNA IZOLIRNOST

Prenos zvoka iz sosednjih prostorov prek stropnih konstrukcij, izračunana v skladu z EN ISO 717-1.



STOPNJA POŽARNE ODPORNOSTI

Klasifikacija odziva na ogenj v skladu z EN 13501-1 izražena v evrozredih (A1–F).



ODPORNOST PROTI VLAGI

Najvišja dovoljena relativna zračna vlažnost za montažo in življenjsko dobo stropa.



ODBOJ SVETLOBE

Odboj svetlobe predstavlja delež vpadne svetlobe, ki ga odseva izdelek, testiran v skladu z EN ISO 7724-2 in 3.



RAZPRŠITEV SVETLOBE

Odstotek razpršene svetlobe.



KAKOVOST ZRAKA

Rešitve Knauf Ceiling Solutions, ki se uporabljajo za omejevanje števila lebdečih delcev v čistem prostoru, so testirane v skladu z ISO 14644-1 in opredeljene z razredom ISO.



PREPUSTNOST ZRAKA

Vrednost zračne prepustnosti izmerjena v skladu z DIN 18177 označuje uhajanje zraka v kubičnih metrih na uro na kvadratni meter.



VSEBNOST RECIKLIRANE SNOVI

Vsebnost reciklirane snovi v izdelku, izračunana v skladu z ISO 14021:2016.



CERTIFIKAT »CRADLE TO CRADLE« (C2C)

Izdelki s tem simbolom imajo certifikat C2C in zagotavljajo pregleden mehanizem za primerjavo trajnostne izdelave izdelkov, ki dokazuje, da so zasnovani za recikliranje ter lahko pomagajo zaščititi in ohraniti naše okolje za prihodnje generacije z daljšim časom ohranjanja virov v gospodarstvu.



OKOLJSKE DEKLARACIJE PROIZVODA (DOKUMENTI EPD)

S strani neodvisnih organov preverjeni in registrirani dokumenti, ki sporočajo pregledne in primerljive informacije o vplivu življenjskega cikla izdelkov na okolje. Dokumente EPD Knauf Ceiling Solutions je v skladu z zahtevami ISO 14025 preveril in certificiral nemški inštitut za gradnjo in okolje IBU (Institut Bauen und Umwelt).



KLASIFIKACIJA M1

Finska emisijska nalepka je ena od najpomembnejših certifikacijskih oznak za gradbene izdelke v Skandinaviji. Oznaka M1 predstavlja najboljšo kategorijo in zagotavlja »nizke emisije«. Klasifikacija M1 določa zahteve za emisije VOC, formaldehida, amonijaka in drugih snovi.



VOC

Količina emisij VOC v skladu s francoskimi zahtevami glede certifikacijskih oznak.



FORMALDEHID (E1)

Stopnja emisije formaldehida (E1 = najnižja možna vrednost).



MODRI ANGEL

Okoljsko oznako Modri angel za okolju prijazne izdelke podeljuje neodvisna žirija. Vsaka oznaka določa, da izdelek izpolnjuje seznam meril v zvezi z varovanjem okolja in zdravja.

www.blauer-engel.de/uz132



ISO 9001

Ta simbol prikazuje, da Knauf Ceiling Solutions dosledno zagotavlja izdelke in storitve, ki izpolnjujejo sistemske zahteve strank in regulativnih organov glede upravljanja kakovosti.



TOPLOTNA PREVODNOST

Vrednost toplotne prevodnosti izmerjena v skladu z EN 12667 označuje stopnjo pretoka toplote skozi material.



OBLIKE ROBOV

Označuje podrobne informacije o robovih, ki so na voljo za posamezno stropno ploščo.



DEBELINA

Označuje debelino posamezne stropne plošče.



DIMENZIJE

Označuje razpoložljive velikosti posameznih stropnih plošč.



SISTEMI

Navaja informacije o sistemih podkonstrukcije, ki so kompatibilni z izbrano ploščo.



TEŽA

Masa na enoto površine izdelka (kg/m²).



BARVA

Izdelki s tem simbolom so na voljo v barvah po želji.



PROTIMIKROBNA PREVLEKA

Mineralni izdelki s tem simbolom in opcijsko kovinske plošče so na voljo z antimikrobno prevleko.



ODPORNOST PROTI PRASKAM

Izdelki s tem simbolom nudijo vrhunsko odpornost proti praskam, ki je testirana s postopkom Hess Rake.



ROKOVANJE Z IZDELKI IN VZDRŽLJIVOST

Rešitve z večjo vzdržljivostjo za boljše rokovanje in odpornost proti poškodbam.

ČIŠČENJE IN RAZKUŽEVANJE

Način in pogostost čiščenja stropa sta odvisna od njegove uporabe. Vse izdelke lahko očistite s suho krpo ali sesalnikom.



Za običajno čiščenje prahu se lahko uporablja mehka krtača, suha bela čista krpa, sesalnik z mehko krtačo, stisnjen zrak.



Za intenzivnejše čiščenje se lahko uporabi vlažno krpo ali gobo. Po čiščenju je potrebno površino posušiti.



Izdelek se lahko čisti z gobo, namočeno v vodo, ki vsebuje blago milo ali razredčen detergent (pH med 7-9). Površino je po čiščenju potrebno posušiti s suho krpo.



Izdelek lahko očistite z visokotlačnim vodnim curkom. Po čiščenju je potrebno površino posušiti.



Za čiščenje s paro mora biti uporabljena naprava, ki ustvarja paro pod pritiskom (8 barov in 175 °C).



Izdelek lahko očistite s posebnimi razkužili, ki jih običajno uporabljajo v zdravstvenih ustanovah. Razkužila so lahko kot spreji ali krpe.

Za dodatne metode čiščenja nas pokličite.

OZNAKA CE

Uredba o gradbenih proizvodih (305/2011/EU) opredeljuje bistvene zahteve za izdelke (in projekte), ki potrjujejo, da so ti varni in primerni za predvideno uporabo. Harmonizirani standardi za izdelke zagotavljajo bistvene zahteve ter določajo preskuse in načine navajanja rezultatov. Za spuščene stropne velja standard EN 13964 Viseči stropi - Zahteve in preskusne metode.

Bistvene zahteve za viseče stropne sisteme (plošče in baffli) vključujejo:

- Odziv na ogenj (obvezno)
- Emisije formaldehida (obvezno)
- Absorpcija zvoka
- Upogibna in natezna trdnost
- Toplotna prevodnost

Za prodajo izdelka na trgu ga je treba v skladu s standardom EN 13964 opremiti z oznako CE in predložiti izjavo o lastnostih.

Vse izjave o lastnostnih izdelkov Knau Ceiling Solutions najdete na spletni strani Knau Ceiling Solutions.

KOEFICIENT ABSORPCIJE ZVOKA, α_w

Enoštevilčna vrednost koeficientov absorpcije zvoka pri naključnem vpadu, izračunana v skladu z EN ISO 11654. S to metodo se vrednost, izmerjene v skladu z EN ISO 354, pretvorijo v oktavne pasove pri 250, 500, 1000, 2000 in 4000 Hz, ki izrišejo graf. To standardno referenčno krivuljo nato primerjamo z izmerjenimi vrednostmi v korakih po 0,05, dokler ne dobimo »največje skladnosti«. Izpeljana vrednost w se premika v območju med 0,00 in 1,00, vendar je izražena le z večkratnikom 0,05, npr. $\alpha_w = 0,65$.

INDIKATOR OBLIKE

V skladu z EN ISO 11654 je izračunana vrednost α_w izražena z enim ali največ dvema indikatorjema (v oklepajih), ki navajata, ali izdelek zagotavlja ustrezno absorpcijo zvoka pri nizkih (L), srednjih (M) ali visokih (H) frekvencah.

RAZRED ABSORPCIJE ZVOKA

V skladu z EN ISO 11654 je mogoče izračunano vrednost w dodatno dodeliti v enega od šestih navedenih razredov v naslednji preglednici:

Razred absorpcije zvoka	α_w
A	0.90; 0.95; 1.00
B	0.80; 0.85
C	0.60; 0.65; 0.70; 0.75
D	0.30; 0.35; 0.40; 0.45; 0.50; 0.55
E	0.15; 0.20; 0.25
Brez razreda	0.00; 0.05; 0.10

OVREDNOTENA NORMIRANA RAZLIKA ZVOČNIH RAVNI VISEČEGA STROPA, D_{ncw}

Enoštevilčno vrednotenje laboratorijskih meritev zvočne izolirnosti hrupa v zraku med dvema prostoroma (horizontalnima) visečega stropa med sosednjima prostoroma, ki si delita skupni medstropni prostor (plenum). Določen je v skladu z EN ISO 717-1 iz meritev opravljenih v skladu z EN 20140-9. Opomba: EN 20140-9 je bil nadomeščen z EN ISO 10848-2, čeprav bodo meritve D_{ncw} še naprej veljale.

OVREDNOTENA NORMIRANA RAZLIKA ZVOČNIH RAVNI STRANSKEGA PRENOSA VISEČEGA STROPA, D_{nfw}

Enoštevilčno vrednotenje laboratorijskih meritev zvočne izolirnosti stranskega prenosa hrupa v zraku med dvema prostoroma (horizontalnima) visečega stropa med sosednjima prostoroma, ki si delita skupni medstropni prostor (plenum). Določen je v skladu z EN ISO 717-1 iz meritev opravljenih v skladu z EN 10848-2. Opomba: Ta standard je nadomestil novi EN 20140-9.

ZVOČNA IZOLATIVNOST, R_w

Enoštevilčna vrednost laboratorijskih meritev (navpičnega) zmanjšanja zvoka visečega stropa. Določena je v skladu z EN ISO 717-1 na podlagi meritev zmanjšanja zvoka, opravljenih v skladu z EN 140-3.

INTENZIVNOST ZVOKA DEŽJA, L_p

Laboratorijsko izmerjena jakost zvoka v prostoru pod strešno konstrukcijo, ki ga ustvarijo padavine. Določa se s sklicevanjem na EN ISO 140-18:2006 – Laboratorijsko merjenje zvoka padavin, ki padajo na konstrukcije. Učinkovitost strešne konstrukcije je mogoče preizkusiti z visečim stropom ali brez njega. Intenzivnost testiranja padavin lahko opravimo z različnimi možnostmi, ki jih navaja standard. Poleg tega lahko določite tudi ponderirano enoštevilčno postavko (LIA). Za razliko od podatkov, ki jih ponujata koeficienta D_{nfw} in R_w , kjer višja vrednost pomeni boljšo izolacijo, pri postavki LIA nižja vrednost pomeni boljše kombinirane izolacijske lastnosti strehe in stropa.

ZVOČNA IZOLIRNOST

Izraz, ki se uporablja v zvezi z navpičnim prenosom zvoka skozi spuščeni strop.

VZDOŽNA ZVOČNA IZOLIRNOST

Izraz, ki se uporablja v zvezi z vodoravnim prenosom zvoka skozi votli prostor nad spuščanim stropom, ki povezuje sosednje prostore.

KOEFICIENT ABSORPCIJE ZVOKA, NRC

Enoštevilčni deskriptor koeficientov absorpcije zvoka pri naključnem vpadu V ASTM C423 je opredeljen kot aritmetično povprečje izmerjenih koeficientov absorpcije zvoka za štiritretjinske srednje frekvence oktavnega pasu 250, 500, 1000 in 2000 Hz.

EKVIVALENTNA ABSORPCIJSKA POVRŠINA (EAA)

Ekvivalentna absorpcijaka površina je podatek koliko določen predmet absorbira (jadra, otoki, pohištvo itd.), če so nameščeni v prostoru. Ker imajo ti absorberji več kot eno površino in so lahko nepravilne oblike, ni jim ni smiselno določiti koeficiente absorpcije zvoka. Zato je absorpcijska površina na enoto primernejša za označevanje absorpcije, ki jo zagotavlja posamezni »prostorski absorber«.

AKUSTIČNE REŠITVE ZA VSAK PROSTOR

Izpolnite vsa pričakovanja zvočnega udobja s Knauf Ceiling Solutions

Knauf Ceiling Solutions ponuja tri gostote stropnih plošč, da je mogoče doseči visoko absorpcijo zvoka, učinkovito zvočno izolativnost oziroma ravnovesje med obema za vse prostorske situacije.

URAVNOTEŽENE AKUSTIČNE LASTNOSTI

Standardna ponudba zagotavlja edinstveno kombinacijo dobre absorpcije zvoka in zvočne izolativnosti, ki omogoča boljše sporazumevanje in večjo učinkovitost na delovnem mestu.

Razumljivost govora opisuje akustično kakovost neposrednega ali prek zvočnikov prenesenega govora v posameznem prostoru.

Razumljivost je lahko izražena kot v decibelih izmerjena razlika med govorom in šumi v ozadju (razmerje med signali in šumi) na mestu poslušalca.

Da bi zagotovili odlično razumljivost, je priporočljivo, da znaša ta razlika na mestu poslušalca z dobrim sluhom 10–15 dB in za osebe z okvaro sluha ali uporabnike slušalk 20–30 dB.

VISOKA ZVOČNA IZOLATIVNOST

Naša ponudba dB ponuja odlično izolacijo in absorpcijo zvoka, ki zagotavlja zasebnost in zaupnost.

Zasebnost opisuje stanje, ko ni mogoče slišati pogovora tretjih oseb.

Za ustrezno zasebnost med sosednjimi prostori je treba upoštevati zvočno izolativnost in glasnost hrupa v ozadju.

VISOKA ABSORPCIJA

Izdelki z učinkovito absorpcijo zvoka so priporočljivi za področja, v katerih je potrebna visoka koncentracija. Ti znatno izboljšajo zvočno udobje v odprtih prostorih, klicnih centrih itd.

Koncentracijo lahko zmotijo različne vrste hrupa, kot so glasovi drugih ljudi, zvonjenje telefonov, klimatske naprave, tipkovnice, oprema, trki, cestni in zračni promet itd.

Vsiljiv hrup zmoti koncentracijo, zato ga je treba obravnavati kot še en ključni dejavnik pri načrtovanju zvočnega okolja.

STRUKTURNA PROTIPOŽARNA ZAŠČITA

Po vsej Evropi so v veljavi predpisi za protipožarno zaščito gradbenih konstrukcij. Ti zagotavljajo, da konstrukcija ostane med požarom stabilna in tako omogoči evakuacijo oseb iz stavbe ter tudi gasilcem omogoča delo brez nevarnosti, da bi se stavba porušila. Čas trajanja predpisane zaščite je običajno odvisen od višine in lokacije znotraj stavbe (tla, klet, strešna konstrukcija itd.), razpoložljivosti aktivnih metod požarne zaščite (sprinklerji itd.) in vrste konstrukcije, ki jo je treba zaščititi (jekleni nosilci, lesene konstrukcije ali medetažni prostori itd.). V primeru konstrukcijske protipožarne zaščite je spuščeni strop klasificiran skupaj z osnovnim stropom in celotno konstrukcijo.

Stropi Knauf Ceiling Solutions dosegajo klasifikacijo gradbenih komponent REI30 do REI120 (odvisno od tipa osnovnega stropa). Redno izvajamo požarne preizkuse, da zagotovimo najvišjo kakovost sistema in vgrajeno varnost za naše kupce.

NEODVISNA PROTIPOŽARNA ZAŠČITA

Neodvisni protipožarni stropi zagotavljajo protipožarno zaščito tako z zgornje (votli medprostori) kot tudi s spodnje strani stropa. Preizkusiti in klasificirati je treba tudi opremo na stropu, kot so razsvetljava, zvočniki, signalizacija itd., ter povezavo z lahkimi pregradnimi sistemi, pregradnimi stenami itd.

V primeru požara v votlem prostoru (pogosto najpogostejši vir požara) so glavne poti za izhod v sili zaščitene z ognjevarnim stropom AMF THERMATEX® Uno, ki ponuja protipožarno zaščito za 30 minut.

Certifikati za protipožarno zaščito, kot je denimo nemški certifikati abP, so na voljo na zahtevo.

KLASIFIKACIJA GRADBENIH MATERIALOV

Odziv spuščениh stropov na ogenj je opredeljen v skladu z evropsko klasifikacijo odziva na ogenj Euroclass. Večina izdelkov Knauf Ceiling Solutions dosega klasifikacijo A2-s1, d0 v skladu z EN 13501-1.

Za več informacij se obrnite na nas ali obiščite www.knaufceilingsolutions.com.

KAKOVOST ZRAKA V PROSTORIH

IZZIV

Svetovna zdravstvena organizacija poroča, da je za 30 odstotkov novozgrajenih in prenovljenih stavb prejetih ogromno pritožb zaradi kakovosti zraka v notranjih prostorih.

Poleg tega slaba kakovost zraka in povišane temperature v prostorih povzročajo, da uspešnost zaposlenih upade za do 10 odstotkov.

REŠITEV

Izdelki Knauf Ceiling Solutions

- Zagotavljajo nizke ali zelo nizke ravni emisij VOC in formaldehida.
- Vsi so bili razvrščeni v razred E1 emisij formaldehida (najboljši možni rezultat testa).
- Velika večina izdelkov dosega oceno A+ (najboljša raven zmogljivosti v skladu s strogim francoskim sistemom označevanja VOC).

V določenih notranjih prostorih, kot so laboratoriji

V določenih področjih je treba bistveno omejiti število lebdečih delcev v zraku. To je mogoče doseči z ustvarjanjem okolja čistih prostorov ali z izdelki, certificiranimi v skladu z ISO 14644-1.

Izdelki Knauf Ceiling Solutions ponujajo rešitve za področja z različnimi zahtevami – od minimalnih do najstrožjih.



Optimalna akustika za določene prostore je priznana za certificiranje trajnosti v skladu z LEED®, BREEAM, HQE, DGNB in WELL Building Standard.

IZZIV

Odsev svetlobe s stropa, tal in sten je drugi najpomembnejši dejavnik za splošno osvetlitev prostora ter neposredno vpliva na delovno udobje, dobro počutje in produktivnost.

REŠITEV

Vključitev stropov z visokim odbojem svetlobe prispevajo k vključitvi v LEED®, BREEAM, HQE, DGNB in Well Building Standard.

Skrbno zasnovan strop z visokim odsevom svetlobe:

- zboljša osvetlitev prostora in zmanjša potrebo po dodatni osvetlitvi, izboljša osvetlitev prostora in omogoča manj svetilk,
- zniža stroške elektrike in vzdrževanja, zmanjša električno moč razsvetljave in zniža stroške vzdrževanja,
- zmanjša hladilno obremenitev.

Stropi z visoko stopnjo odboja svetlobe odbijejo do 87 odstotkov svetlobe nazaj v prostor.

Stropna jadra nameščena nad delovnim mestom izboljšajo odsev svetlobe in tako zagotavljajo večje udobje končnega uporabnika.



Cradle to Cradle Certified®

Program Cradle to Cradle Certified® je bil razvit za zadovoljitev naraščajočega povpraševanja kupcev po trajnostnih izdelkih, certifikat C2C pa se že uveljavlja kot pogoj za gradbene projekte v ZDA in Evropi. Projektu doda vrednost ter pomaga pri zaščiti in ohranjanju našega okolja za prihodnje generacije tako, da podaljšuje čas uporabe virov v gospodarstvu. Izdelki s certifikatom Cradle to Cradle Certified® so priznani v standardih LEED® in WELL Building.



IMI

Integrated Micro-Electronics
Niš



DELOVNA MESTA, KI ZAGOTAVLJAJO PRIJETNEJŠE DELO

Povprečna oseba preživi na delovnem mestu približno 90-tisoč ur. Naša odgovornost je, da naredimo te prostore prijetnejše za vse.

Tu ne gre le za zadovoljstvo – čeprav drži, da zadovoljnejši zaposleni delajo bolje. Tukaj gre za dobro počutje na delovnem mestu. Dobro počutje povečuje produktivnost. Izboljša zmogljivost, zmanjša stres ter prispeva k ravnovesju med poklicnim in zasebnim življenjem, ki omogoča, da ljudje izkoristijo svoj maksimalni potencial. In eden od načinov, kako lahko pripomoremo k dobremu počutju na delovnem mestu, je dobra zasnova stavbe.

Pametno načrtovanje lahko z upoštevanjem estetike, svetlobe, sence in razdelitve prostora tudi najbolj enolično pisarno odprtega tipa spremeni v živahen, dinamičen prostor, ki sodobno arhitekturo kombinira z oblikovalsko zasnovo z optičnim in akustičnim udobjem ter tako znatno izboljša dobro počutje in zadovoljstvo, produktivnost in učinkovitost.

Naša načela, ki jih uporabljamo pri ureditvi vrhunskih pisarn, lahko tudi izven teh premislekov ustvarijo funkcionalnejše in učinkovitejše prostore za delo. Prostore za tesno sodelovanje in tiho zbranost; prostore, ki zagotavljajo zasebnost med pogovori ali zagotavljajo odlične pogoje za razprave in prostore za osredotočeno delo, ki navdušujejo tako delavce kot tudi obiskovalce. To je naša naloga, odgovornost in priložnost, da skupaj ustvarimo delovne prostore, ki omogočajo boljše delo.



USTVARIMO PROSTORE, KI NAVDIHUJEJO

Izobrazba, ki se nas drži vse življenje, je odvisna od učiteljev, ki posredujejo učne vsebine z znanjem in strastjo – vendar ti mentorji potrebujejo za to pravo okolje.

Izobrazba, ki se nas drži vse življenje, je odvisna od učiteljev, ki posredujejo učne vsebine z znanjem in strastjo – vendar ti mentorji potrebujejo za to pravo okolje.

Šole, fakultete in univerze so zapleteni ekosistemi in njihove stavbe morajo biti ustvarjene za ta namen. Obsegajo vse, od učilnic, v katerih je mogoče osredotočeno učenje, tihih delovnih prostorov in obsežnih avditorijev do predavalnic, zvočnih studiev in prostorov za druženje. Vsak prostor ima svoje zahteve in posebnosti – vsi pa morajo biti optimizirani za učinkovito izobraževanje.

Kako to zagotoviti? Veliko pozornosti je treba nameniti načrtovanju območij in kako vsak prostor deluje individualno in kot del celotnega ekosistema. Potrebno je ravnovesje med akustično zmogljivostjo in optičnim udobjem –kjer je učitelje mogoče jasno slišati tudi v zadnji vrsti in kjer se učenci lahko osredotočijo na svoje delo.

Predvsem pa je potrebna zavest, občutljivost in zavzetost za ustvarjanje varnega, zdravega in mirnega okolja za uspešno izobraževanje in predanost za ustvarjanje prostorov, kjer bodo učitelji poučevali z navdihom.



OBLIKUJMO IZKUŠNJO NAKUPOVANJA

Pot do nakupa nikoli ne poteka v ravni črti. Na poti je cel kup dejavnikov, ki lahko vplivajo na odločitve stranke. Eden je gotovo maloprodajno okolje in vtisi, ki jih ustvarja.

Ne glede na to, ali gre za supermarket ali trgovino, nakupovalni center ali razstavni salon, restavracije ali modni butik, zasnova maloprodajnega okolja je bistvena za nakupovalno izkušnjo – in to izkušnjo bi morali obravnavati kot vsako drugo izkušnjo, ki nam je pomembna. Ta izkušnja bi morala biti udobna in nezapletena, hkrati pa bi morala imeti elemente presenečenja, nas navdušiti, zabavati in privabiti.

Materiali, tehnologije in tehnike, ki jih uporabljamo za ustvarjanje maloprodajnih okolij, imajo pri tem ključno vlogo. Fascinantne oblikovne značilnosti, igriva manipulacija svetlobe in senc, barve in oblike, svetli, odprti prostori, intuitivne poti in akustično udobni, prijetni prostori, ki spodbujajo interakcijo s strankami in poenostavljajo postopek prodaje. Vsi ti elementi so pomembni za pozitivno nakupovalno izkušnjo.

Z mešanjem funkcionalnosti in blišča s pridihom odličnega dizajna ne navdihujemo le blagovnih znamk z novim življenjem, ampak ustvarjamo tudi nakupovalno izkušnjo, v kateri bodo ljudje uživali in si jo bodo zapomnili in delili z drugimi.



NO SMOKING

MS Antares



KASSE

3901

FRAGILE

3801

3814

POČUTITE SE KOT DOMA

Počitek in sprostitev sta ključnega pomena za vsak način življenja – še posebej, ker je način življenja vsakogar drugačen. Toda ne glede na to, kaj ljudje počnejo v svojem prostem času, bi morali biti njihovi prostori za prosti čas tako živahni, kot narekuje njihov namen.

Enkrat je na urniku šport z visokim tempom ali trening v fitnesu, drugič večerja v restavraciji, obisk hotela ali samo sprostitev ob filmu v kinematografu. Na voljo je ogromno prostorov za preživljanje prostega časa, a vsi imajo eno oblikovno in arhitekturo značilnost, ki jo morajo upoštevati: ustvarjanje pravega vzdušja za izboljšanje kakovosti življenja.

V kinu lahko dosežemo to z akustičnim ravnovesjem, ki gledalcem omogoča vrhunsko uživanje ob filmu. Fitnes centre lahko preplavimo s svetlobo in hkrati ohranimo učinkovito porazdelitev toplote ter povečamo odpornost proti vlagi. Hotel lahko zasnujemo kot del večnamenske stavbe, v kateri nas osupljiva preddverja in hodniki popeljejo do udobnih hotelskih sob.

Za vsako arhitekturno oviro v prostorih za prosti čas in gostinstvo obstaja ideja, ki vam bo pomagala, da jo premostite – rešitev, ki omogoča lažje in učinkovitejše delo. Dejstvo je, da si vsi občasno zaslužimo sprostitev.



USTVARJANJE PROSTOROV ZA ZDRAVLJENJE

Arhitektura v zdravstvu mora ustrezati visokim zahtevam – ne glede na to, ali gre za čakalnico v lokalni ordinaciji ali operacijsko dvorano. V vsakem prostoru je treba upoštevati vrsto dejavnikov, ki so ključnega pomena za ohranjanje življenja.

Najpomembnejši element je seveda ustvarjanje prostora, ki je primeren za skrb za zdravje – to pomeni zagotavljanje vrhunske higijene na protimikrobni ravni ter materialov in tehnologij, ki izboljšujejo kakovost zraka v notranjih prostorih in zmanjšujejo emisije, ter varovanje pacientov in negovalcev z robustno protipožarno zaščito.

Poleg tega je naša odgovornost, da ustvarimo okolje, ki aktivno pospešuje proces zdravljenja. Glede na dokazan pomen naravne svetlobe za dobro počutje je nujno, da so naši zdravstveni prostori svetli in prostorni ter da ponujajo visoko stopnjo odboja svetlobe, ki kar najbolje izkoristi postavitev oken. Tudi akustično morajo ti prostori dobro absorbirati in izolirati hrup in ljudem zagotoviti mir in tišino, da se lahko odpočijejo in okrevajo.

Če povzamemo: zdravstveni prostori morajo biti tako funkcionalno kot tudi estetsko popolnoma usklajeni s svojim namenom. Čisti in preprosti, svetli in prijazni, mirni in udobni. Morajo ponujati vse, kar potrebujejo zdravniki za svoje delo in pacienti za okrevanje, ter imeti vse potrebno za ustvarjanje popolnih prostorov za zdravljenje.



ARHITEKTURA, KI PREMICA LJUDI

Naš svet je ves čas v gibanju – več milijard ljudi potuje med mesti in celinami. Stavbe, v katere prihajajo in odhajajo, imajo vedno odločilno vlogo pri izboljšanju vsakega potovanja.

Od salonov na letališčih do hal železniških postaj, od predelov z restavracijami do peronov – arhitektura prevoza je potovanje. Stropi, stene in tla so spremljevalci popotnikov; prve in zadnje stvari, ki jih vidijo na vsaki lokaciji, ozadja srečanja in slovesa – in ključni del potovanj ljudi.

Zato je treba te stavbe obravnavati z racionalnega kot tudi čustvenega vidika. Morajo biti funkcionalne in potnike voditi do dostopov, čakalnic in peronov. Biti morajo čiste, preproste za vzdrževanje in trpežne in vsak dan kljubovati milijonom potnikov. Hkrati pa morajo imeti pomirjujoč in vabljev čar, ki spodbuja odkrivanje.

Zato je treba temne prehode in čakalnice, ki so bile nekoč značilne za prometna vozlišča, preoblikovati v svetle, odprte in privlačne prostore, ki obvladujejo hrup in množice ljudi za vesplošno dobro počutje. In vse to z impresivno zasnovano in notranjo ureditvijo, ki premika ljudi – v fizičnem in čustvenem smislu.

DIZAJN

MINERAL Baffle Element	30	MINERAL Wallcoustic Element	42
MINERAL Baffle Element Arc	32	MINERAL Wallcoustic Line	44
MINERAL Baffle Line L / N	34	FABRIC Wallcoustic Line	46
MINERAL Sonic Element	36	AMF THERMATEX® Alpha Colour	48
MINERAL Sonic Line Arc	38	Focus: AMF THERMATEX® Varioline	50
MINERAL Sonic Line	40		

GLADKO BELO AKUSTIČNO

AMF THERMATEX® Acoustic	54	Armstrong PERLA OP 0.95	68
AMF THERMATEX® dB Acoustic	56	Armstrong PERLA OP 19mm	70
AMF THERMATEX® Alpha HD 19mm	58	Armstrong PERLA OP 1.00	72
AMF THERMATEX® Alpha HD 30mm	60	AMF THERMATEX® Thermofon	74
AMF THERMATEX® Alpha HD 35mm	62	AMF TOPIQ® Prime	76
AMF THERMATEX® Alpha One	64	AMF TOPIQ® Efficient Pro	78
Armstrong PERLA	66		

ZDRAVSTVO & HIGIENA

MEDIGUARD Alpha	82	HYGENA Plain	94
MEDIGUARD Acoustic	84	AMF THERMATEX® Aquatec	96
MEDIGUARD Plain	86	AMF THERMATEX® Thermaclean	98
HYGENA Aquatec	88	AMF TOPIQ® Prime Hygena	100
HYGENA Alpha	90	AMF TOPIQ® Efficient Pro Hygena	102
HYGENA Acoustic 15mm	92	Armstrong NEWTONE	104

KLASIČNO GLADKO

PLAIN **108**

KLASIČNO STRUKTURIRANO

Armstrong SAHARA **112** AMF THERMATEX® Feinstratos **114**

KLASIČNO PERFORIRANO

Star 15mm **118** AMF THERMATEX® Feinfresko **120**

POŽARNA ZAŠČITA

AMF THERMATEX® Uno **124**

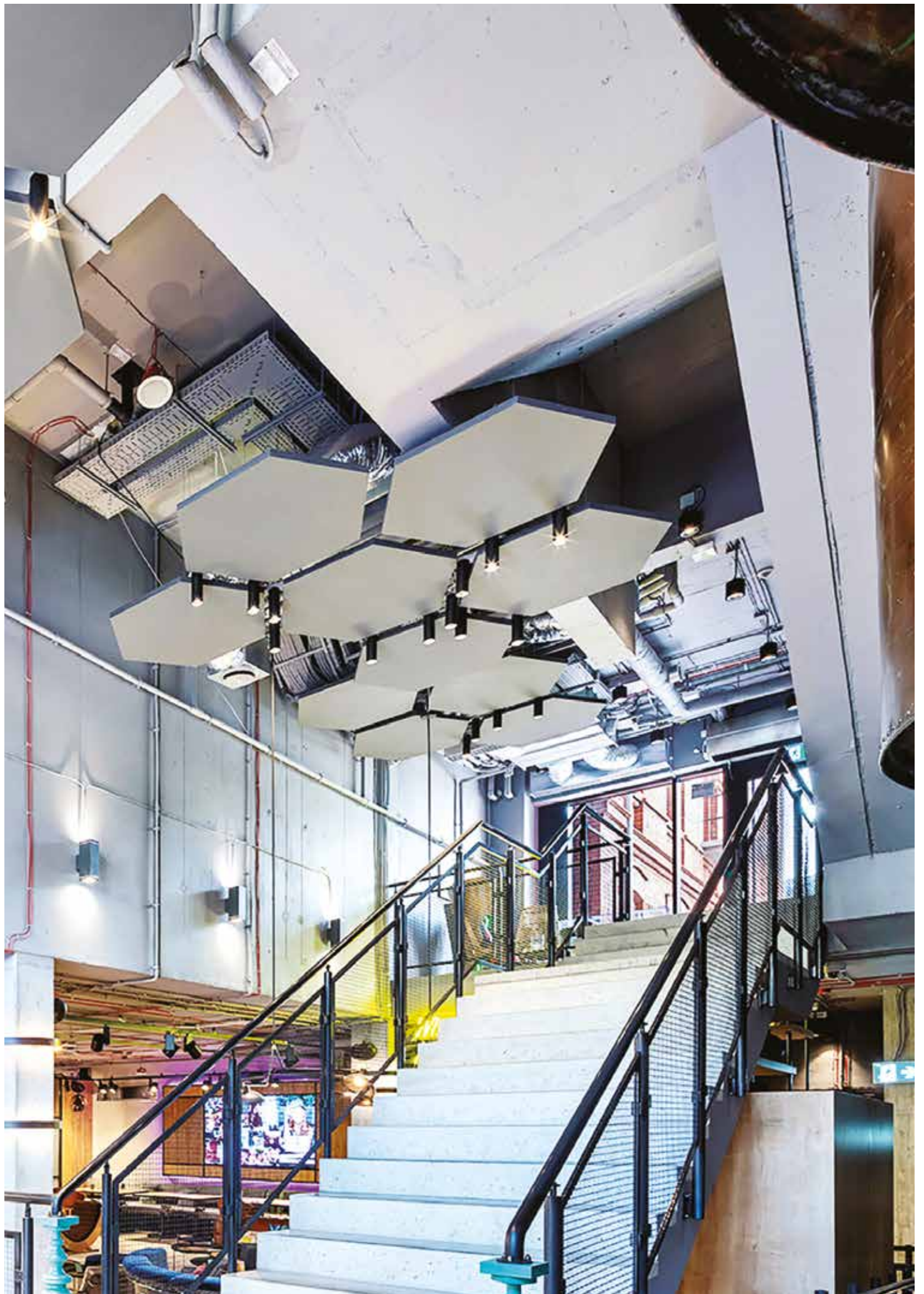

Dizajn

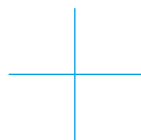

V SVETU, KJER JE PODOBA BISTVENEGA POMENA, DAJEJO NAŠE PRILAGODLJIVE STROPNE REŠITVE NAVDIH ZA USTVARJANJE OSUPLJIVE ESTETIKE IN VZDUŠJA DOBREGA POČUTJA.

Mogoča je neskončna paleta dramatičnih možnosti oblikovanja – z baffli, stropnimi jadrji, stenskimi absorberji in dodatki, ki jih je mogoče preprosto namestiti in prestaviti. Izpostavljene površine, ki absorbirajo zvok, da izboljšajo akustiko in hkrati odbijajo do 87 odstotkov svetlobe, da ustvarijo svetlejša, energetska učinkovitejša prostora. In brezzšivni, monolitno lebdeči stropi, ki sodobnemu oblikovanju stavbe dodajo barvo, obliko, globino, širino in ritem.





Sistemi vertikalnih absorberjev - baffli

MINERAL Baffle Element

(OPTIMA Baffle)

Samostojno / Skupinsko



- MINERAL Baffle Element je program akustičnih vertikalnih absorberjev z belo laminirano površino za moderen linearen videz.
- Dobra zvočna absorpcija: zmanjšajo hrup, povečajo razumljivost govora ter zmanjšajo odmevni čas v prostoru.
- Uporabljajo se v pisarnah, wellnessih, transportnih vozliščih za izboljšanje absorpcije zvoka.



Sistemi vertikalnih absorberjev - baffli
MINERAL Baffle Element
 Samostojno / Skupinsko

Debelina (mm)		39																						
Dimenzije (mm) Druge dimenzije po povpraševanju		1200 x 300 1200 x 400	1800 x 300 1800 x 400																					
Sistemi		Set obešal iz žice Skupinsko obešanje z U-Profilu Skupinsko obešanje s T profili																						
Teža		1200 x 300: 3.8 kg/kos 1200 x 400: 5.0 kg/kos	1800 x 300: 5.6 kg/kos 1800 x 400: 7.5 kg/kos																					
Barva in dizajn																								
Absorpcija zvoka		EN ISO 354 $\alpha_w = 0.50(MH)$ (300mm) skladno z EN ISO 11654 - Class D Frekvenca f (Hz) <table border="1"> <tr> <td></td> <td>125</td> <td>250</td> <td>500</td> <td>1000</td> <td>2000</td> <td>4000</td> </tr> <tr> <td>Baffles 1200 x 300mm</td> <td></td> <td></td> <td></td> <td></td> <td></td> <td></td> </tr> <tr> <td>α_p Razmik med vrstami 300mm</td> <td>0.15</td> <td>0.25</td> <td>0.45</td> <td>0.90</td> <td>0.90</td> <td>0.95</td> </tr> </table> NRC = 0.65 (300mm) skladno z ASTM C 423			125	250	500	1000	2000	4000	Baffles 1200 x 300mm							α_p Razmik med vrstami 300mm	0.15	0.25	0.45	0.90	0.90	0.95
	125	250	500	1000	2000	4000																		
Baffles 1200 x 300mm																								
α_p Razmik med vrstami 300mm	0.15	0.25	0.45	0.90	0.90	0.95																		
Stopnja požarne odpornosti		Euroclass A2-s1,d0 skladno z EN 13501-1																						
Odpornost proti vlagi		90%																						
Kakovost zraka		 A+	 E1	 IACG																				
Čiščenje																								
Trajnost		 EC 1272/2008 Annex G																						

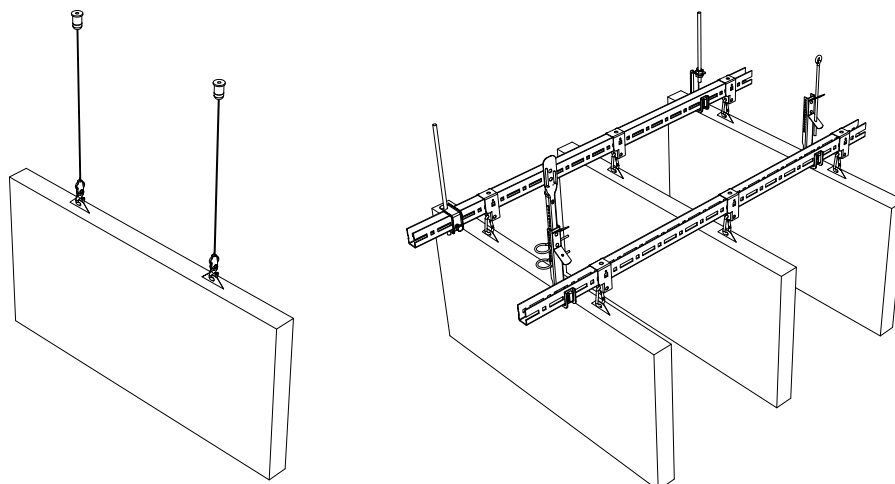

vd Opcije s to ikono so dobavljive v **Vario Design** programu.
 Razpoložljivost izdelkov se lahko razlikuje od države do države.
 Za več informacij se obrnite na lokalnega prodajnega predstavnika.
 Dodatne in pravne informacije najdete na naši spletni strani



Sistemi vertikalnih absorberjev - baffli

MINERAL Baffle Element Arc

(OPTIMA Baffle Curves)
Samostojno / Skupinsko

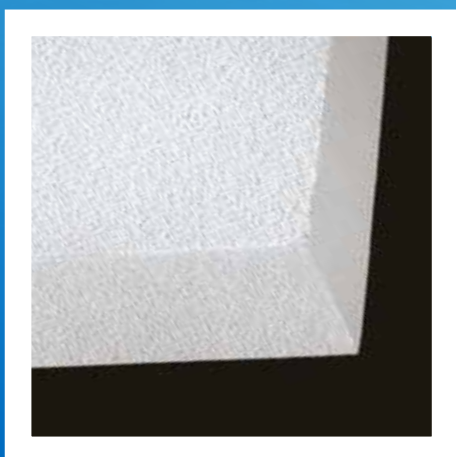

- Z MINERAL Baffle Element Arc lahko brez kompromisov ustvarimo zanimive akustične interierje, tudi v modernih odprtih prostorih.
- Modern ukrivljen izgled
- Zmanjšujejo raven hrupa, izboljšajo razumljivost govora ter zmanjšajo odmevni čas v prostoru.
- Lahko se montirajo samostojno ali pa v skupini.
- Običajno se uporabljajo za izboljšanje akustike v pisarnah, wellnessih ter transportnih postajališčih.



Sistemi vertikalnih absorberjev - baffli
MINERAL Baffle Element Arc
 Samostojno / Skupinsko

Debelina (mm)		39														
Dimenzije (mm) Druge dimenzije po povpraševanju		1200 x 400 1800 x 400														
Sistemi		Set obešal iz žice Skupinsko obešanje z U-Profilu Skupinsko obešanje z glavnimi T profili														
Teža		1200 x 400: 5.0 kg/kos 1800 x 400: 7.5 kg/kos														
Barva in dizajn		<div style="display: flex; align-items: center;"> <div style="margin-right: 10px;"></div> <div style="margin-right: 10px;"></div> <div style="margin-right: 10px;"></div> <div style="margin-right: 10px;"></div> <div style="margin-right: 10px;"></div> <div style="margin-right: 10px;"></div> <div style="margin-right: 10px;"></div> <div style="margin-right: 10px;"></div> <div style="margin-right: 10px;"></div> </div> <p style="font-size: small; margin-top: 5px;">Vario Design barve</p>														
Absorpcija zvoka		<p>EN ISO 354</p> <p>$\alpha_w = 0.50(MH)$ skladno z EN ISO 11654 - Class D</p> <table border="1" style="font-size: x-small; width: 100%; border-collapse: collapse;"> <thead> <tr> <th>Frekvenca f (Hz)</th> <th>125</th> <th>250</th> <th>500</th> <th>1000</th> <th>2000</th> <th>4000</th> </tr> </thead> <tbody> <tr> <td>α_p Razmik med vrstami 300mm</td> <td>0.15</td> <td>0.25</td> <td>0.45</td> <td>0.90</td> <td>0.90</td> <td>0.95</td> </tr> </tbody> </table> <p>NRC = 0.65 skladno z ASTM C 423</p>	Frekvenca f (Hz)	125	250	500	1000	2000	4000	α_p Razmik med vrstami 300mm	0.15	0.25	0.45	0.90	0.90	0.95
Frekvenca f (Hz)	125	250	500	1000	2000	4000										
α_p Razmik med vrstami 300mm	0.15	0.25	0.45	0.90	0.90	0.95										
Stopnja požarne odpornosti		Euroclass A2-s1,d0 skladno z EN 13501-1														
Odpornost proti vlagi		90%														
Kakovost zraka		<div style="display: flex; justify-content: space-around; align-items: center;"> <div style="text-align: center;"> A+ </div> <div style="text-align: center;"> E1 </div> <div style="text-align: center;"> IACG </div> </div>														
Čiščenje																
Trajnost		BIOSOLUBLE WOOL EC 1272/2008 Annex Q														

MINERAL Baffle Element Arc

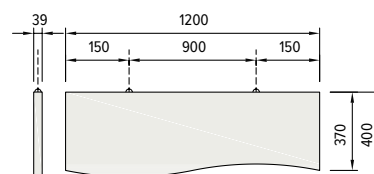
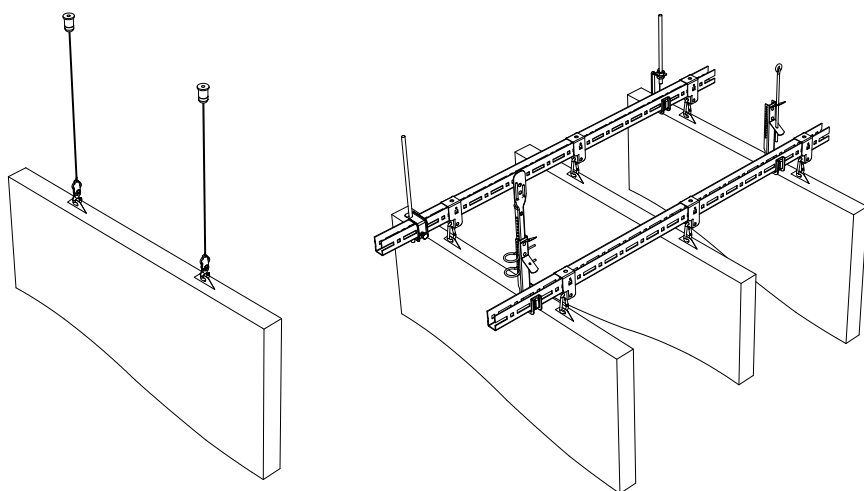

Module 1200 x 400 mm

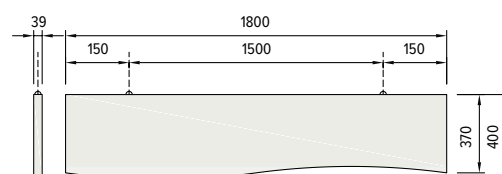

Module 1800 x 400 mm

vd Opcije s to ikono so dobavljive v **Vario Design** programu.
 Razpoložljivost izdelkov se lahko razlikuje od države do države.
 Za več informacij se obrnite na lokalnega prodajnega predstavnika.
 Dodatne in pravne informacije najdete na naši spletni strani



Sistemi vertikalnih absorberjev - baffli

MINERAL Baffle Line L/N

(THERMATEX® Baffle)

Samostojno / Skupinsko (samo MINERAL Baffle Line L)



- MINERAL Baffle Line L in Line N imajo aluminijast okvir ter laminirano površino za moderen linearni izgled. MINERAL Baffle Line L in Line N so dobavljivi tudi v različnih barvah ter s tiskom po želji.
- Dobra zvočna absorpcija (0.60 - 0.65(H) α_w): zniža hrup, izboljša razumljivost govora in zmanjša odmevni čas v prostoru.
- Največkrat se uporablja za izboljšanje akustike v pisarnah, wellness centrih, transportnih vozliščih...
- Dobra zvočna absorpcija (0.60 - 0.65(H) α_w): zniža hrup, izboljša razumljivost govora in zmanjša odmevni čas v prostoru.
- Največkrat se uporablja za izboljšanje akustike v pisarnah, wellness centrih, transportnih vozliščih...



MINERAL Baffle Line L/N

Samostojno / Skupinsko (samo MINERAL Baffle Line L)

Debelina (mm)		50																						
Dimenzije (mm) Druge dimenzije po povpraševanju		1200 x 300 1200 x 400	1800 x 300 1800 x 400																					
Sistemi		MINERAL Baffle Line N - jeklenica z navojem MINERAL Baffle Line L - jeklenica s kljukico																						
Teža		1200 x 300: 3.2 kg/kos 1200 x 400: 4.1 kg/kos	1800 x 300: 4.7 kg/kos 1800 x 400: 6.0 kg/kos																					
Barva in dizajn		Okvir: Anodiziran aluminij, Bela, Barve Motif: Tisk po želji																						
Absorpcija zvoka		EN ISO 354 $\alpha_w = \mathbf{0.60(MH)}$ (300mm) skladno z EN ISO 11654 - Class C <table border="1"> <thead> <tr> <th>Frekvenca f (Hz)</th> <th>125</th> <th>250</th> <th>500</th> <th>1000</th> <th>2000</th> <th>4000</th> </tr> </thead> <tbody> <tr> <td>Baffles 1200 x 300mm</td> <td></td> <td></td> <td></td> <td></td> <td></td> <td></td> </tr> <tr> <td>α_p Razmik med vrstami 300mm</td> <td>0.35</td> <td>0.40</td> <td>0.55</td> <td>0.90</td> <td>0.90</td> <td>0.90</td> </tr> </tbody> </table> NRC = 0.65 skladno z ASTM C 423		Frekvenca f (Hz)	125	250	500	1000	2000	4000	Baffles 1200 x 300mm							α_p Razmik med vrstami 300mm	0.35	0.40	0.55	0.90	0.90	0.90
Frekvenca f (Hz)	125	250	500	1000	2000	4000																		
Baffles 1200 x 300mm																								
α_p Razmik med vrstami 300mm	0.35	0.40	0.55	0.90	0.90	0.90																		
Stopnja požarne odpornosti		Euroclass A2-s1,d0 skladno z EN 13501-1																						
Odboj svetlobe		88%																						
Odpornost proti vlagi		90%																						
Čiščenje																								
Trajnost																								

MINERAL Baffle Line L

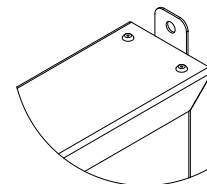
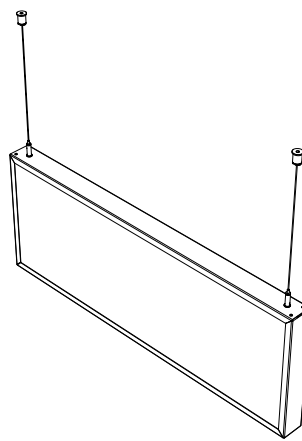
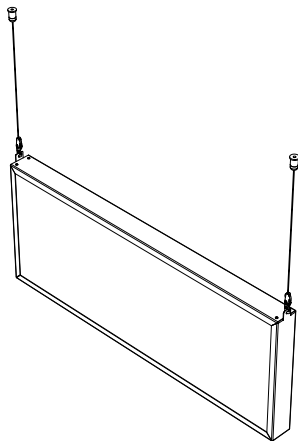
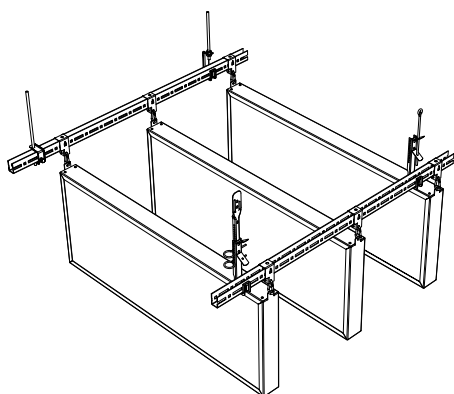

MINERAL Baffle Line L

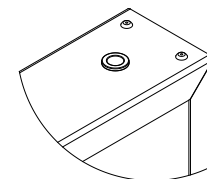

MINERAL Baffle Line N

vd Opcije s to ikono so dobavljive v **Vario Design** programu.
Razpoložljivost izdelkov se lahko razlikuje od države do države.
Za več informacij se obrnite na lokalnega prodajnega predstavnika.
Dodatne in pravne informacije najdete na naši spletni strani

Sistemi visečih absorberjev - jadra
MINERAL Sonic Element
(TOPIQ® Sonic Element, Optima Canopy)
Samostojno / Skupinsko



- MINERAL Sonic element je jadro brez okvirja ter brez stikov. Vidna površina je prevlečena z barvano tkanino ter na zadnji strani je laminiran filc.
- Monolitna akustična jadra nudijo odlično zvočno absorpcijo in ko so ta zmontirana dajejo izgled samostojnih stropnih oblakov.

MINERAL Sonic Element

Samostojno / Skupinsko

Debelina (mm)		40																																										
Dimenzije (mm) Druge dimenzije in oblike po povpraševanju		<table border="0"> <tr> <td>Trapez</td> <td>1180 x 870</td> <td>Pravokotnik</td> <td>1780 x 1180</td> </tr> <tr> <td>Šestkotnik</td> <td>1363 x 1180</td> <td>Pravokotnik</td> <td>2380 x 1180</td> </tr> <tr> <td>Paralelogram, levi</td> <td>1180 x 1180</td> <td>Krog</td> <td>Ø800</td> </tr> <tr> <td>Paralelogram, desni</td> <td>1180 x 1180</td> <td>Krog</td> <td>Ø1200</td> </tr> <tr> <td>Kvadrat</td> <td>800 x 800</td> <td>Krog</td> <td>Ø1600</td> </tr> <tr> <td>Kvadrat</td> <td>1180 x 1180</td> <td>Konveksno</td> <td>1170 x 1170</td> </tr> <tr> <td>Pravokotnik</td> <td>1180 x 580</td> <td>Konkavno</td> <td>1170 x 1020</td> </tr> <tr> <td>Pravokotnik</td> <td>1780 x 880</td> <td>Trikotnik</td> <td>1180 x 1022</td> </tr> </table>	Trapez	1180 x 870	Pravokotnik	1780 x 1180	Šestkotnik	1363 x 1180	Pravokotnik	2380 x 1180	Paralelogram, levi	1180 x 1180	Krog	Ø800	Paralelogram, desni	1180 x 1180	Krog	Ø1200	Kvadrat	800 x 800	Krog	Ø1600	Kvadrat	1180 x 1180	Konveksno	1170 x 1170	Pravokotnik	1180 x 580	Konkavno	1170 x 1020	Pravokotnik	1780 x 880	Trikotnik	1180 x 1022										
Trapez	1180 x 870	Pravokotnik	1780 x 1180																																									
Šestkotnik	1363 x 1180	Pravokotnik	2380 x 1180																																									
Paralelogram, levi	1180 x 1180	Krog	Ø800																																									
Paralelogram, desni	1180 x 1180	Krog	Ø1200																																									
Kvadrat	800 x 800	Krog	Ø1600																																									
Kvadrat	1180 x 1180	Konveksno	1170 x 1170																																									
Pravokotnik	1180 x 580	Konkavno	1170 x 1020																																									
Pravokotnik	1780 x 880	Trikotnik	1180 x 1022																																									
Sistemi		Obešanje z jekenicami Skupinsko: U-profil																																										
Teža		6.0 kg/m ²																																										
Barva in dizajn		<div style="border: 1px solid #ccc; padding: 5px;"> <div style="display: flex; align-items: center;"> <div style="width: 20px; height: 20px; background-color: #fff; border: 1px solid #ccc; margin-right: 5px;"></div> <div style="font-size: 0.8em; font-weight: bold; color: #0070C0;">Vario Design barve</div> </div> <div style="display: flex; justify-content: space-around; margin-top: 5px;"> <div style="text-align: center;"> <div style="width: 30px; height: 30px; background-color: #fff; border: 1px solid #ccc; margin: 0 auto;"></div> <div style="font-size: 0.7em;">Bela</div> </div> <div style="text-align: center;"> <div style="width: 30px; height: 30px; background-color: #444; border: 1px solid #ccc; margin: 0 auto;"></div> <div style="font-size: 0.7em;">Granit</div> </div> <div style="text-align: center;"> <div style="width: 30px; height: 30px; background-color: #557788; border: 1px solid #ccc; margin: 0 auto;"></div> <div style="font-size: 0.7em;">Jeklo</div> </div> <div style="text-align: center;"> <div style="width: 30px; height: 30px; background-color: #779966; border: 1px solid #ccc; margin: 0 auto;"></div> <div style="font-size: 0.7em;">Zeleni marmor</div> </div> <div style="text-align: center;"> <div style="width: 30px; height: 30px; background-color: #A52A2A; border: 1px solid #ccc; margin: 0 auto;"></div> <div style="font-size: 0.7em;">Baker</div> </div> <div style="text-align: center;"> <div style="width: 30px; height: 30px; background-color: #C08040; border: 1px solid #ccc; margin: 0 auto;"></div> <div style="font-size: 0.7em;">Hrast</div> </div> <div style="text-align: center;"> <div style="width: 30px; height: 30px; background-color: #D4C040; border: 1px solid #ccc; margin: 0 auto;"></div> <div style="font-size: 0.7em;">Medenina</div> </div> <div style="text-align: center;"> <div style="width: 30px; height: 30px; background-color: #E0D0C0; border: 1px solid #ccc; margin: 0 auto;"></div> <div style="font-size: 0.7em;">Pesek</div> </div> <div style="text-align: center;"> <div style="width: 30px; height: 30px; background-color: #A0A0A0; border: 1px solid #ccc; margin: 0 auto;"></div> <div style="font-size: 0.7em;">Beton</div> </div> </div> </div>																																										
Absorpcija zvoka		<p>EN ISO 354</p> <table border="1" style="width: 100%; border-collapse: collapse; font-size: 0.8em;"> <thead> <tr> <th>Frekvenca f (Hz)</th> <th>125</th> <th>250</th> <th>500</th> <th>1000</th> <th>2000</th> <th>4000</th> </tr> </thead> <tbody> <tr> <td>Ekvivalentna absorpcijska površina *</td> <td></td> <td></td> <td></td> <td></td> <td></td> <td></td> </tr> <tr> <td>Kvadrat: 1180 x 1180mm / Višina spuščanja 190mm</td> <td>0.40</td> <td>1.20</td> <td>2.20</td> <td>2.40</td> <td>2.40</td> <td>2.30</td> </tr> <tr> <td>Pravokotnik: 1780 x 1180mm / Višina spuščanja 190mm</td> <td>0.80</td> <td>2.10</td> <td>3.10</td> <td>3.30</td> <td>3.50</td> <td>3.40</td> </tr> <tr> <td>Pravokotnik: 2380 x 1180mm / Višina spuščanja 190mm</td> <td>0.80</td> <td>2.70</td> <td>4.20</td> <td>4.40</td> <td>4.50</td> <td>4.30</td> </tr> <tr> <td>Krog: Ø1200mm / Višina spuščanja 150mm</td> <td>0.40</td> <td>1.00</td> <td>1.70</td> <td>1.80</td> <td>2.00</td> <td>1.90</td> </tr> </tbody> </table> <p style="text-align: right; font-size: 0.7em;">*Vrednosti prikazujeno povprečje 1/3 oktave</p>	Frekvenca f (Hz)	125	250	500	1000	2000	4000	Ekvivalentna absorpcijska površina *							Kvadrat: 1180 x 1180mm / Višina spuščanja 190mm	0.40	1.20	2.20	2.40	2.40	2.30	Pravokotnik: 1780 x 1180mm / Višina spuščanja 190mm	0.80	2.10	3.10	3.30	3.50	3.40	Pravokotnik: 2380 x 1180mm / Višina spuščanja 190mm	0.80	2.70	4.20	4.40	4.50	4.30	Krog: Ø1200mm / Višina spuščanja 150mm	0.40	1.00	1.70	1.80	2.00	1.90
Frekvenca f (Hz)	125	250	500	1000	2000	4000																																						
Ekvivalentna absorpcijska površina *																																												
Kvadrat: 1180 x 1180mm / Višina spuščanja 190mm	0.40	1.20	2.20	2.40	2.40	2.30																																						
Pravokotnik: 1780 x 1180mm / Višina spuščanja 190mm	0.80	2.10	3.10	3.30	3.50	3.40																																						
Pravokotnik: 2380 x 1180mm / Višina spuščanja 190mm	0.80	2.70	4.20	4.40	4.50	4.30																																						
Krog: Ø1200mm / Višina spuščanja 150mm	0.40	1.00	1.70	1.80	2.00	1.90																																						
Stopnja požarne odpornosti		Euroclass A2-s1,d0 skladno z EN 13501-1																																										
Odboj svetlobe		Do 88%																																										
Odpornost proti vlagi		90%																																										
Kakovost zraka		<div style="display: flex; justify-content: space-around; align-items: center;"> <div style="text-align: center;"> A </div> <div style="text-align: center;"> E1 </div> <div style="text-align: center;"> IAC </div> </div>																																										
Čiščenje																																												
Trajnost		 <small>EC 1272/2008 Annex Q</small>																																										

Možnost oblike po naročilu ter izvedba različnih višin spuščanja.

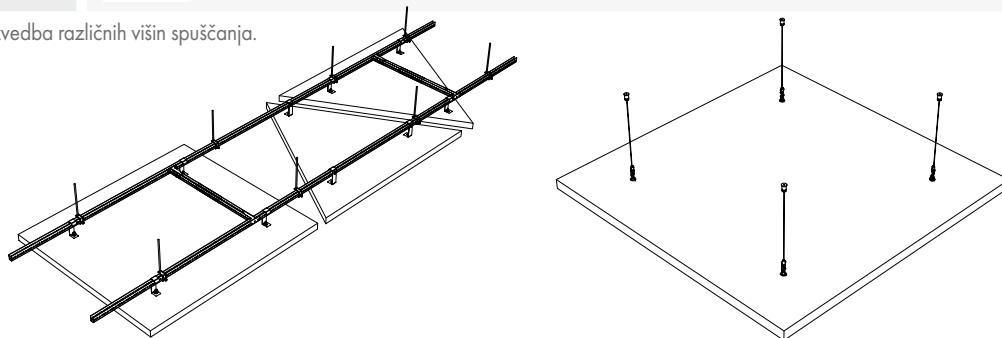

vd Opcije s to ikono so dobavljive v **Vario Design** programu.
Razpoložljivost izdelkov se lahko razlikuje od države do države.
Za več informacij se obrnite na lokalnega prodajnega predstavnika.
Dodatne in pravne informacije najdete na naši spletni strani



Sistemi visečih absorberjev - jadra

MINERAL Sonic Line Arc

(THERMATEX® Sonic Arc)

Samostojno



- Oblikujte prostor z MINERAL Sonic Arc konkavnimi ali konveksnimi elementi.
- Izbirajte med različnimi barvami in izdelajte kontrastne učinke.
- Z jadri MINERAL Sonic Line Arc izrazite svojo kreativnost in prostoru dodate poseben efekt.



MINERAL Sonic Line Arc

Samostojno

Oblika roba		MINERAL Sonic Line Arc Konkavno 	MINERAL Sonic Line Arc Konveksno 																					
Debelina (mm)		35																						
Dimenzije (mm)		1910 x 1180																						
Sistemi		Obešeno na jeklenice																						
Teža		16.0 kg/kos																						
Barva in dizajn																								
Absorpcija zvoka		EN ISO 354 <table border="1"> <thead> <tr> <th>Frekvenca f (Hz)</th> <th>125</th> <th>250</th> <th>500</th> <th>1000</th> <th>2000</th> <th>4000</th> </tr> </thead> <tbody> <tr> <td>Ekvivalentna absorpcijska površina *</td> <td>0.40</td> <td>1.60</td> <td>2.40</td> <td>2.70</td> <td>3.20</td> <td>3.40</td> </tr> <tr> <td>Višina spuščanja 185mm</td> <td>0.40</td> <td>1.60</td> <td>2.40</td> <td>2.70</td> <td>3.20</td> <td>3.40</td> </tr> </tbody> </table> <p style="text-align: right; font-size: small;">* Vrednosti prikazujemo povprečje 1/3 oktave</p>		Frekvenca f (Hz)	125	250	500	1000	2000	4000	Ekvivalentna absorpcijska površina *	0.40	1.60	2.40	2.70	3.20	3.40	Višina spuščanja 185mm	0.40	1.60	2.40	2.70	3.20	3.40
Frekvenca f (Hz)	125	250	500	1000	2000	4000																		
Ekvivalentna absorpcijska površina *	0.40	1.60	2.40	2.70	3.20	3.40																		
Višina spuščanja 185mm	0.40	1.60	2.40	2.70	3.20	3.40																		
Stopnja požarne odpornosti		Euroclass A2-s1,d0 skladno z EN 13501-1																						
Odboj svetlobe		Do 88%																						
Odpornost proti vlagi		90%																						
Čiščenje	 																							
Trajnost																								

MINERAL Sonic Line Arc Konkavno

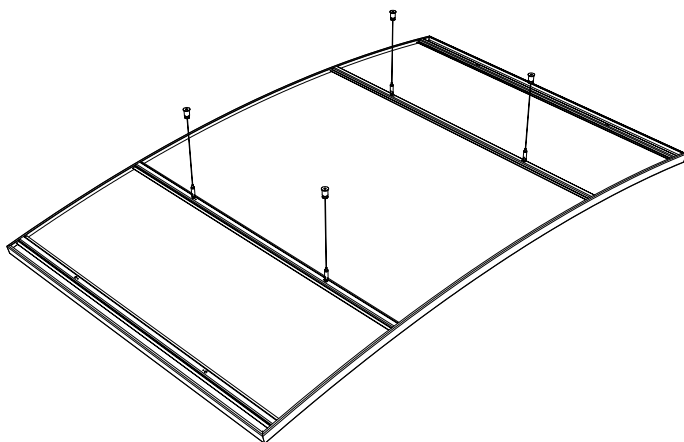

MINERAL Sonic Line Arc Konveksno

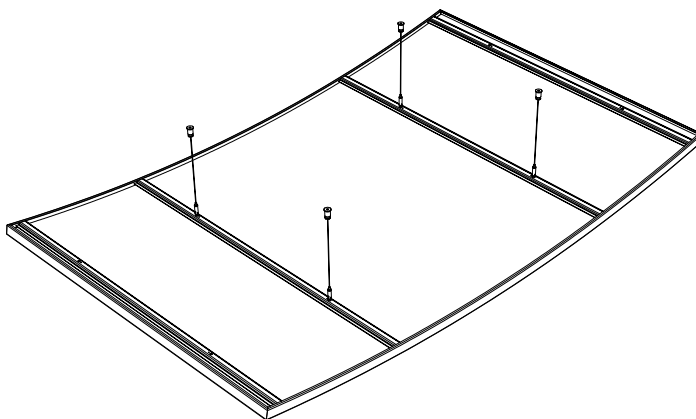

Stropna jadra so dobavljiva v enem kosu, kar omogoča hitro in enostavno montažo. Višina spuščanja je prilagodljiva z uporabo jeklenic.























Sistemi visečih absorberjev - jadra
MINERAL Sonic Line
(THERMATEX® Sonic Modern)
Samostojno



- MINERAL Sonic Line je stropno jadro z aluminijastim okvirjem. S prilagodljivimi jeklenicami lahko določimo višino obešanje kakor želimo.
- Dobavljivo v standardni beli laminirani površini. Lahko dobavljivo tudi v barvah ali z motivom po izbiri.
- V šolah, pisarnah in trgovinah estetsko poudarijo prostor.

Sistemi visečih absorberjev - jadra
MINERAL Sonic Line
 Samostojno

Debelina (mm)		43																												
Dimenzije (mm)		1200 x 600 1200 x 1200 1800 x 1200 2400 x 1200																												
Sistemi		Obešeno na jeklenice																												
Teža		1200 x 600: 5.0 kg/kos 1200 x 1200: 10.0 kg/kos 1800 x 1200: 15.0 kg/kos 2400 x 1200: 20.0 kg/kos																												
Barva in dizajn		<p>Okvir: Anodiziran aluminij, Bela, Barve</p> <div style="display: flex; align-items: center;"> <div style="border: 1px solid black; width: 30px; height: 30px; margin-right: 10px;"></div> <div style="font-size: 0.8em; margin-right: 10px;">Vario Design barve</div> </div> <div style="display: flex; justify-content: space-around; margin-top: 5px;"> <div style="text-align: center;"> Bela</div> <div style="text-align: center;"> Granit</div> <div style="text-align: center;"> Jeklo</div> <div style="text-align: center;"> Zeleni marmor</div> <div style="text-align: center;"> Baker</div> <div style="text-align: center;"> Hrast</div> <div style="text-align: center;"> Medenina</div> <div style="text-align: center;"> Pesek</div> <div style="text-align: center;"> Beton</div> </div> <p>Motif: Tisk po želji</p>																												
Absorpcija zvoka		<p>EN ISO 354</p> <table border="1" style="width: 100%; border-collapse: collapse; font-size: 0.8em;"> <thead> <tr> <th style="text-align: left;">Frekvenca <i>f</i> (Hz)</th> <th>125</th> <th>250</th> <th>500</th> <th>1000</th> <th>2000</th> <th>4000</th> </tr> </thead> <tbody> <tr> <td>Ekvivalentna absorpcijska površina*</td> <td></td> <td></td> <td></td> <td></td> <td></td> <td></td> </tr> <tr> <td>1200 x 1200mm Višina spuščanja 193mm</td> <td>0.40</td> <td>1.10</td> <td>1.60</td> <td>2.00</td> <td>2.10</td> <td>2.00</td> </tr> <tr> <td>2400 x 1200mm Višina spuščanja 193mm</td> <td>0.90</td> <td>1.90</td> <td>3.00</td> <td>3.40</td> <td>3.80</td> <td>3.70</td> </tr> </tbody> </table> <p style="text-align: right; font-size: 0.7em;">*Vrednosti prikazujeno povprečje 1/3 oktave</p>	Frekvenca <i>f</i> (Hz)	125	250	500	1000	2000	4000	Ekvivalentna absorpcijska površina*							1200 x 1200mm Višina spuščanja 193mm	0.40	1.10	1.60	2.00	2.10	2.00	2400 x 1200mm Višina spuščanja 193mm	0.90	1.90	3.00	3.40	3.80	3.70
Frekvenca <i>f</i> (Hz)	125	250	500	1000	2000	4000																								
Ekvivalentna absorpcijska površina*																														
1200 x 1200mm Višina spuščanja 193mm	0.40	1.10	1.60	2.00	2.10	2.00																								
2400 x 1200mm Višina spuščanja 193mm	0.90	1.90	3.00	3.40	3.80	3.70																								
Stopnja požarne odpornosti		Euroclass A2-s1,d0 skladno z EN 13501-1																												
Odboj svetlobe		Do 88%																												
Odpornost proti vlagi		90%																												
Čiščenje	 																													
Trajnost																														

Stropna jadra so dobavljiva v enem kosu, kar omogoča hitro in enostavno montažo. Različne dimenzije. Višina spuščanja je prilagodljiva z uporabo jeklenic.

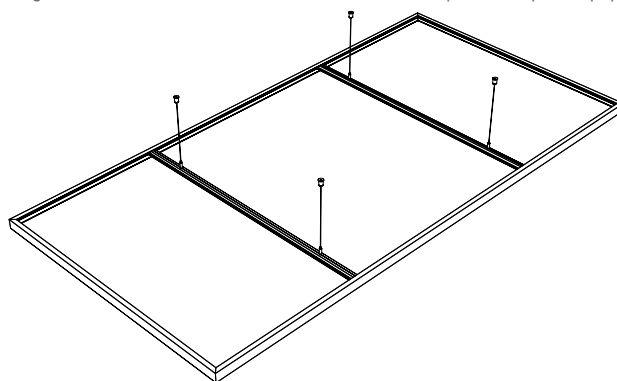

vd Opcije s to ikono so dobavljive v **Vario Design** programu.
 Razpoložljivost izdelkov se lahko razlikuje od države do države.
 Za več informacij se obrnite na lokalnega prodajnega predstavnika.
 Dodatne in pravne informacije najdete na naši spletni strani



©Philip Durrant

Stenski sistemi

MINERAL Wallcoustic Element

(OPTIMA Canopy, OPTIMA L Canopy, TOPIQ® Line Element)

Samostojno



- MINERAL Wallcoustic Element je stenski absorber brez okvirja ter brez stikov. Vidne površine so laminirane z barvano tkanino, na zadnji strani je laminiran flis.
- Monolitni stenski absorber nudi odlično absorpcijo zvoka in neskončno oblikovnih možnosti za ambiciozne arhitekta, ki želijo izboljšati izgled ter akustiko notranjih prostorov.
- Stenski panel je dobavljiv v enem kosu in se hitro in enostavno montira s spiralnimi vijaki ter stenskimi nosilci.



MINERAL Wallcoustic Element

Samostojno

Debelina (mm)		40																												
Dimenzije (mm) Druge dimenzije po povpraševanju		Kvadrat 1180 x 1180 Kvadrat 800 x 800 Pravokotnik 1180 x 580 Pravokotnik 1780 x 880 Pravokotnik 1780 x 1180																												
Sistemi		Spiralni vijak Stenski nosilci																												
Teža		6.0 kg/m ²																												
Barva in dizajn		VD Vario Design barve Bela Granit Jeklo Zeleni marmor Baker Hrast Medenina Pesek Beton																												
Absorpcija zvoka		EN ISO 354 <table border="1"> <thead> <tr> <th>Frekvenca f (Hz)</th> <th>125</th> <th>250</th> <th>500</th> <th>1000</th> <th>2000</th> <th>4000</th> </tr> </thead> <tbody> <tr> <td>Ekvivalentna absorpcijska površina*</td> <td></td> <td></td> <td></td> <td></td> <td></td> <td></td> </tr> <tr> <td>Kvadrat: 1180 x 1180mm</td> <td>0.40</td> <td>1.20</td> <td>1.90</td> <td>1.90</td> <td>1.90</td> <td>1.80</td> </tr> <tr> <td>Pravokotnik: 1780 x 1180mm</td> <td>0.50</td> <td>1.70</td> <td>2.70</td> <td>2.80</td> <td>2.80</td> <td>2.60</td> </tr> </tbody> </table> *Vrednosti prikazujemo povprečje 1/3 oktave	Frekvenca f (Hz)	125	250	500	1000	2000	4000	Ekvivalentna absorpcijska površina*							Kvadrat: 1180 x 1180mm	0.40	1.20	1.90	1.90	1.90	1.80	Pravokotnik: 1780 x 1180mm	0.50	1.70	2.70	2.80	2.80	2.60
Frekvenca f (Hz)	125	250	500	1000	2000	4000																								
Ekvivalentna absorpcijska površina*																														
Kvadrat: 1180 x 1180mm	0.40	1.20	1.90	1.90	1.90	1.80																								
Pravokotnik: 1780 x 1180mm	0.50	1.70	2.70	2.80	2.80	2.60																								
Stopnja požarne odpornosti		Euroclass A2-s1,d0 skladno z EN 13501-1																												
Odboj svetlobe		Do 88%																												
Odpornost proti vlagi		90%																												
Čiščenje																														
Trajnost																														

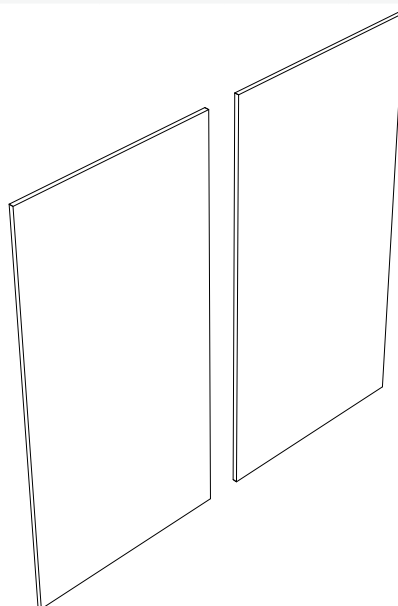



Stenski sistemi

MINERAL Wallcoustic Line

(THERMATEX® Line Modern)

Samostojno



- MINERAL Wallcoustic Line je sestavljen stenski absorber iz aluminijastega obodnega profila ter bele laminirane površine. Dobavljiv je tudi v različnih barvah ali s potiskom po želji.
- Prostoru doda nov vizualni izgled in izboljša prostorsko akustiko.
- Stenski absorber je dobavljen v enem kosu ter se enostavno in hitro montira z ekscentričnimi vijaki.



Stenski sistemi
MINERAL Wallcoustic Line
 Samostojno

Debelina (mm)		43																																										
Dimenzije (mm) Druge dimenzije po povpraševanju		1200 x 600 1200 x 1200 1800 x 1200 2400 x 1200																																										
Sistemi		Ekscentrična obešala																																										
Teža		9.4 kg/m ²																																										
Barva in dizajn		<p>Okvir: Anodiziran aluminij, Bela, Barve</p> <div style="border: 1px solid #ccc; padding: 5px;"> <p>VD Vario Design barve</p> <table style="width: 100%; text-align: center;"> <tr> <td></td> <td></td> <td></td> <td></td> <td></td> <td></td> <td></td> <td></td> <td></td> </tr> <tr> <td>Bela</td> <td>Granit</td> <td>Jeklo</td> <td>Zeleni marmor</td> <td>Baker</td> <td>Hrast</td> <td>Medenina</td> <td>Pesek</td> <td>Beton</td> </tr> </table> </div> <p>Motif: Tisk po želji</p>										Bela	Granit	Jeklo	Zeleni marmor	Baker	Hrast	Medenina	Pesek	Beton																								
Bela	Granit	Jeklo	Zeleni marmor	Baker	Hrast	Medenina	Pesek	Beton																																				
Absorpcija zvoka		<p>EN ISO 354</p> <table border="1" style="width: 100%; border-collapse: collapse;"> <thead> <tr> <th>Frekvenca f (Hz)</th> <th>125</th> <th>250</th> <th>500</th> <th>1000</th> <th>2000</th> <th>4000</th> </tr> </thead> <tbody> <tr> <td>Ekvivalentna absorpcijska površina *</td> <td></td> <td></td> <td></td> <td></td> <td></td> <td></td> </tr> <tr> <td>Pravokotnik: 1200 x 600mm</td> <td>0.20</td> <td>0.60</td> <td>1.00</td> <td>0.90</td> <td>0.80</td> <td>0.90</td> </tr> <tr> <td>Kvadrat: 1200 x 1200mm</td> <td>0.50</td> <td>1.10</td> <td>1.60</td> <td>1.50</td> <td>1.50</td> <td>1.50</td> </tr> <tr> <td>Pravokotnik: 1800 x 1200mm</td> <td>0.60</td> <td>1.90</td> <td>2.50</td> <td>2.40</td> <td>2.20</td> <td>2.40</td> </tr> <tr> <td>Pravokotnik: 2400 x 1200mm</td> <td>1.10</td> <td>2.20</td> <td>3.10</td> <td>3.10</td> <td>3.00</td> <td>3.10</td> </tr> </tbody> </table> <p style="text-align: right; font-size: small;">*Vrednosti prikazujeno povprečje 1/3 oktave</p>	Frekvenca f (Hz)	125	250	500	1000	2000	4000	Ekvivalentna absorpcijska površina *							Pravokotnik: 1200 x 600mm	0.20	0.60	1.00	0.90	0.80	0.90	Kvadrat: 1200 x 1200mm	0.50	1.10	1.60	1.50	1.50	1.50	Pravokotnik: 1800 x 1200mm	0.60	1.90	2.50	2.40	2.20	2.40	Pravokotnik: 2400 x 1200mm	1.10	2.20	3.10	3.10	3.00	3.10
Frekvenca f (Hz)	125	250	500	1000	2000	4000																																						
Ekvivalentna absorpcijska površina *																																												
Pravokotnik: 1200 x 600mm	0.20	0.60	1.00	0.90	0.80	0.90																																						
Kvadrat: 1200 x 1200mm	0.50	1.10	1.60	1.50	1.50	1.50																																						
Pravokotnik: 1800 x 1200mm	0.60	1.90	2.50	2.40	2.20	2.40																																						
Pravokotnik: 2400 x 1200mm	1.10	2.20	3.10	3.10	3.00	3.10																																						
Stopnja požarne odpornosti		Euroclass A2-s1,d0 skladno z EN 13501-1																																										
Odboj svetlobe		Do 88%																																										
Odpornost proti vlagi		90%																																										
Čiščenje																																												
Trajnost																																												

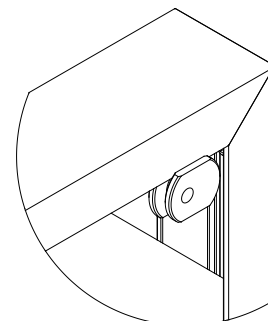
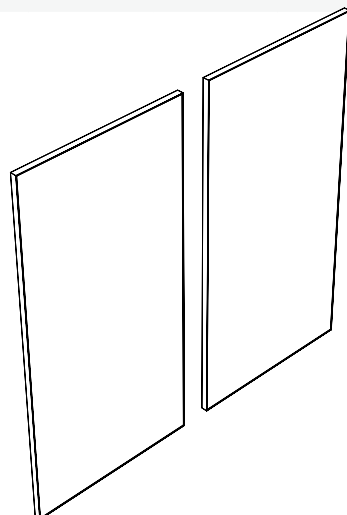

Detajl: Ekscentrično obešalo

vd Opcije s to ikono so dobavljive v **Vario Design** programu.
 Razpoložljivost izdelkov se lahko razlikuje od države do države.
 Za več informacij se obrnite na lokalnega prodajnega predstavnika.
 Dodatne in pravne informacije najdete na naši spletni strani



Stenski sistemi

FABRIC Wallcoustic Line

(LINE Style)

Samostojno











- FABRIC Wallcoustic Line je stenski zvočni absorber prekrit z akustično tiskano tkanino z motivom po želji. Absorber je vstavljen v aluminijast okvir, kateri ima izdelan utor v katerega se vstavi tiskano tkanino. Tkanina se lahko kadarkoli odstrani in zamenja z novo, brez uporabe posebnih orodij.
- FABRIC Wallcoustic Line 20: Ozek profil za enostransko prekrivanje, za majhne dimezije, $d = 20$ mm.
- FABRIC Wallcoustic Line 27: Profil za enostransko prekrivanje, za vse dimezije.
- FABRIC Wallcoustic Line 50: Lahek profil debeline 50 mm z možnostjo dvostranskega prekrivanja.



FABRIC Wallcoustic Line

Samostojno

Debelina (mm) 	20	27	50																					
Dimenzije (mm) 	600 x 600 1 200 x 600	1200 x 1200 1800 x 1200 2400 x 1200 2400 x 2400	600 x 600 1200 x 600 1200 x 1200 1800 x 1200 2400 x 1200 2400 x 2400																					
Sistemi 	Stenska obešala																							
Teža 	3.0 - 6.0 kg/m ²																							
Barva in dizajn 	Okvir: Anodiziran aluminij, Bela, po-RAL u FABRIC Wallcoustic Line 20: Tkanina, Bela, Tisk po želji FABRIC Wallcoustic Line 27: Tkanina, Bela, Tisk po želji FABRIC Wallcoustic Line 50: Tkanina, Bela, Tisk po želji																							
Absorpcija zvoka 	EN ISO 354 <table border="1"> <thead> <tr> <th>Frekvenca f (Hz)</th> <th>125</th> <th>250</th> <th>500</th> <th>1000</th> <th>2000</th> <th>4000</th> </tr> </thead> <tbody> <tr> <td>Ekvivalentna absorpcijska površina *</td> <td></td> <td></td> <td></td> <td></td> <td></td> <td></td> </tr> <tr> <td>1200 x 1200mm (50mm debelina)</td> <td>0.30</td> <td>0.90</td> <td>1.90</td> <td>1.90</td> <td>1.80</td> <td>1.60</td> </tr> </tbody> </table> <p style="text-align: right;">*Vrednosti prikazujeno povprečje 1/3 oktave</p>			Frekvenca f (Hz)	125	250	500	1000	2000	4000	Ekvivalentna absorpcijska površina *							1200 x 1200mm (50mm debelina)	0.30	0.90	1.90	1.90	1.80	1.60
Frekvenca f (Hz)	125	250	500	1000	2000	4000																		
Ekvivalentna absorpcijska površina *																								
1200 x 1200mm (50mm debelina)	0.30	0.90	1.90	1.90	1.80	1.60																		
Odpornost proti vlagi 	90%																							
Čiščenje	 																							

FABRIC Wallcoustic Line

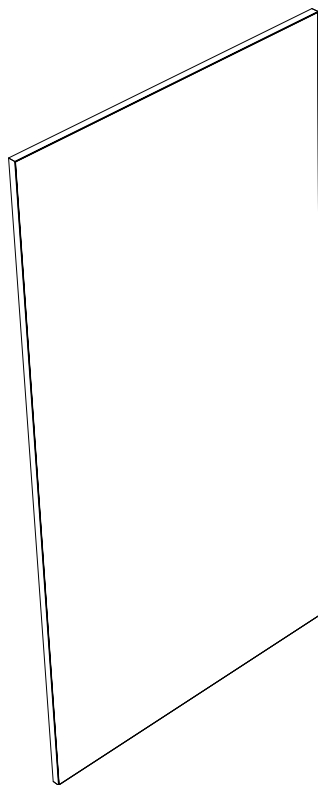

Prerez profila

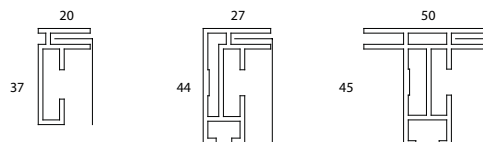

Kotni spoj

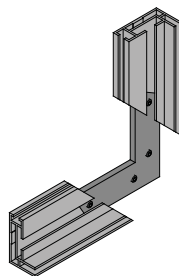

Detajl okvirja

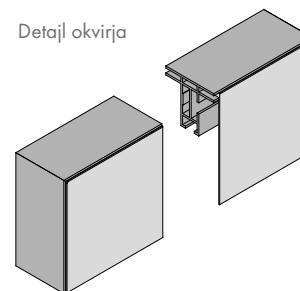



















AMF THERMATEX® Alpha Colour



- Plošče AMF THERMATEX® Alpha Color nudijo moderen videz in istočasno nudijo maksimalno zvočno absorpcijo. Poleg bež, črne in srebrne laminirane površine so na voljo tudi akustične površine Vario Design v barvah granita, jekla, zelenega marmorja, bakra, hrasta, medenine, betona.
- Odlična zvočna absorpcija ($0,95 \alpha_w$)
- Idealno za pisarne, restavracije, kino dvorane, in izobraževalne ustanove



AMF THERMATEX® ALPHA COLOUR

Oblike robov Drugi robovi po povpraševanju	 Board 																												
Debelina (mm)	 19																												
Dimenzije (mm) Druge dimenzije po povpraševanju	 <table border="0"> <tr> <td>600 x 600</td> <td>1200 x 600</td> </tr> <tr> <td>610 x 610</td> <td>1220 x 610</td> </tr> <tr> <td>625 x 625</td> <td>1250 x 625</td> </tr> </table>	600 x 600	1200 x 600	610 x 610	1220 x 610	625 x 625	1250 x 625																						
600 x 600	1200 x 600																												
610 x 610	1220 x 610																												
625 x 625	1250 x 625																												
Sistemi	 Vidni sistem, snemljive plošče - sistem C																												
Teža	 3.3 kg / m ²																												
Barva Druge barve po povpraševanju	 <table border="0"> <tr> <td> Črna</td> <td> Srebrna</td> <td> Bež</td> <td colspan="8">vs Vario Design barve</td> </tr> <tr> <td> Granit</td> <td> Jeklo</td> <td> Zeleni marmor</td> <td> Baker</td> <td> Hrast</td> <td> Medenina</td> <td> Pesek</td> <td> Beton</td> <td colspan="2"></td> </tr> </table>	 Črna	 Srebrna	 Bež	vs Vario Design barve								 Granit	 Jeklo	 Zeleni marmor	 Baker	 Hrast	 Medenina	 Pesek	 Beton									
 Črna	 Srebrna	 Bež	vs Vario Design barve																										
 Granit	 Jeklo	 Zeleni marmor	 Baker	 Hrast	 Medenina	 Pesek	 Beton																						
Absorpcija zvoka	 <p>EN ISO 354 $\alpha_w = 1.00$ skladno z EN ISO 11654 - Klasa A (crna) $\alpha_w = 0.95$ skladno z EN ISO 11654 - Klasa A (ostale boje)</p> <table border="1"> <thead> <tr> <th>Frekvenca f (Hz)</th> <th>125</th> <th>250</th> <th>500</th> <th>1000</th> <th>2000</th> <th>4000</th> </tr> </thead> <tbody> <tr> <td>α_p crna</td> <td>0.45</td> <td>0.80</td> <td>0.95</td> <td>0.95</td> <td>1.00</td> <td>1.00</td> </tr> <tr> <td>Frequency f (Hz)</td> <td>125</td> <td>250</td> <td>500</td> <td>1000</td> <td>2000</td> <td>4000</td> </tr> <tr> <td>α_p ostale boje</td> <td>0.50</td> <td>0.80</td> <td>0.90</td> <td>0.90</td> <td>1.00</td> <td>1.00</td> </tr> </tbody> </table> <p>NRC = 0.90 skladno z ASTM C 423</p>	Frekvenca f (Hz)	125	250	500	1000	2000	4000	α_p crna	0.45	0.80	0.95	0.95	1.00	1.00	Frequency f (Hz)	125	250	500	1000	2000	4000	α_p ostale boje	0.50	0.80	0.90	0.90	1.00	1.00
Frekvenca f (Hz)	125	250	500	1000	2000	4000																							
α_p crna	0.45	0.80	0.95	0.95	1.00	1.00																							
Frequency f (Hz)	125	250	500	1000	2000	4000																							
α_p ostale boje	0.50	0.80	0.90	0.90	1.00	1.00																							
Vzdolžna zvočna izolativnost	 <p>EN ISO 10848-2 $D_{n,f,w} = 28$ dB skladno z EN ISO 717-1</p>																												
Zvočna izolativnost	 <p>EN ISO 10140-2 $R_w = 14$ dB skladno z EN ISO 717-1</p>																												
Stopnja požarne odpornosti	 Euroclass A2-s1, d0 skladno z EN 13501-1 RUS KM1 (G1, V1, D1, T1) skladno z 123-FZ																												
Toplotna prevodnost	 $\lambda = 0.040$ W/mk skladno z EN 12667																												
Prepustnost zraka	 PM1 (≤ 30 m ³ /hm ²) skladno z DIN 18177																												
Odpornost proti vlagi	 95% RH																												
Kakovost zraka	<table border="0"> <tr> <td> A+</td> <td> E1</td> <td> IACG</td> </tr> </table>	 A+	 E1	 IACG																									
 A+	 E1	 IACG																											
Čiščenje	 																												
Trajnost	<table border="0"> <tr> <td> EN ISO 14021</td> <td> EC 1275/2008 Annex G</td> <td></td> </tr> <tr> <td>43%</td> <td colspan="2" style="text-align: center;">www.blauer-engel.de/uz132</td> </tr> </table>	 EN ISO 14021	 EC 1275/2008 Annex G		43%	www.blauer-engel.de/uz132																							
 EN ISO 14021	 EC 1275/2008 Annex G																												
43%	www.blauer-engel.de/uz132																												

vs Opcije s to ikono so dobavljive v programu Vario Design.
 Razpoložljivost izdelkov se lahko razlikuje od države do države.
 Za več informacij se obrnite na lokalnega prodajnega predstavnika.

IZKUSITE VEČ MOŽNOSTI



AMF THERMATEX® Varioline

AMF THERMATEX® Varioline omogoča praktično neomejene možnosti oblikovanja.

Neglede na to, kakšen izgled imate v mislih, izberete lahko mineralne plošče z videzom lesa, kovine ali betona, da dosežete zeleni končni videz.

Kupcem so na voljo tudi prilagojene izvedbe, ki pomagajo prilagoditi in izboljšati ambient vsakega prostora.

Izberite med naslednjimi rešitvami – AMF THERMATEX® Varioline Motif, Varioline Metal, Varioline Wood, Varioline Symetra in Varioline Colour, da izpolnite zahteve za zvočno, estetsko in požarno učinkovitost svojega projekta.



Varioline Motif

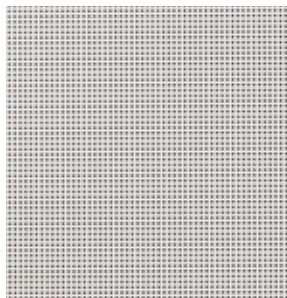

Varioline Metal



Varioline Wood

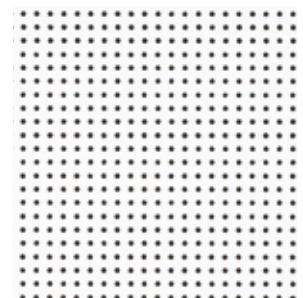

Varioline Symetra

Gladko Belo Akustično

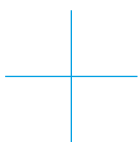

**GLADEK, BEL IN AKUSTIČNO OPTIMIZIRAN PORTFELJ NUDI
NAJŠIRŠO IZBIRO IZVEDB ROBOV, MODULOV IN AKUSTIČNIH
MOŽNOSTI.**

Zasnovan za večjo prilagodljivost in optimalno akustiko v vsakem prostoru – z visoko absorpcijo zvoka, visoko zvočno izolativnostjo ali ravnovesjem med obema. S svojo gladko, belo površino nudijo ti estetski stropi tudi visoko mero odboja svetlobe in varčevanja z energijo.





TEHNIČNI LIST

AMF THERMATEX[®]

Acoustic

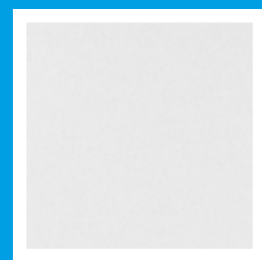

- Laminirane plošče AMF THERMATEX[®] Acoustic imajo gladko belo površino in nudijo dobro zvočno absorpcijo in odlično zvočno izolativnost.
- Dobra zvočna absorpcija (0.65 (H) α_w)
- Odlična zvočna izolativnost (40 dB; SL2)
- Visoka zvočna izolativnost (38 dB; Board, Tegular 24/90, Tegular 15/90, Vector, Finesse)
- Odlična svetlobna odbojnost (88 %)
- ISO 4
- Primerno za pisarne, sejne sobe, učilnice, hodnike

TEHNIČNI LIST

AMF THERMATEX® Acoustic

Oblike robov Drugi robovi po povpraševanju		Board 	Tegular 24/90 	Tegular 15/90 	SL2 	Vector 	Finesse 	
Debeline (mm)		19	19	19	19	24	19	
Dimenzije (mm)		600 x 600 625 x 625 1200 x 600 1250 x 625	600 x 600 625 x 625 1200 x 600	600 x 600 1200 x 600	1200 x 300 1500 x 300 1800 x 300 2000 x 300 2500 x 300	600 x 600 625 x 625 1200 x 600	600 x 600 625 x 625 1200 x 600 1250 x 625	
Sistemi		Vidni sistem, snemljive plošče - sistem C			Lamelne snemljive plošče - sistem I.3 Konstrukcija z vzporednim bandrastrom, lamelne snemljive plošče - sistem I.2 Prsto vpeti sistem z zakritimi nosilnimi profili, snemljive plošče - sistem F.2	Snemljivi sistem s polzakrito senčno fugo - sistem C	Skrita podkonstrukcija, snemljive plošče - sistem A2./A.3	
Teža		5.0 - 8.6 kg / m ²						
Barve		 Bela						
Zvočna absorpcija		EN ISO 354 $\alpha_w = 0.65$ (H) skladno z EN ISO 11654 - Razred C						
		Frekvenca f (Hz)	125	250	500	1000	2000	4000
		α_p Board, Tegular 24/90, Tegular 15/90, Finesse, SL2	0.50	0.45	0.60	0.85	0.95	0.95
		α_p Vector	0.45	0.40	0.60	0.80	0.90	1.00
		NRC = 0.70 skladno z ASTM C 423						
Vzdolžna zvočna izolativnost		EN ISO 10848-2 $D_{n,f,w} = 38$ dB (Board, Tegular 24/90, Tegular 15/90, Vector, Finesse) skladno z EN ISO 717-1 $D_{n,f,w} = 40$ dB (SL2) skladno z EN ISO 717-1 CAC = 39 dB (Board, Tegular 24/90, Tegular 15/90, Vector, Finesse) skladno z ASTM E 413-10						
Zvočna izolativnost		EN ISO 10140-2 $R_w = 22$ dB skladno z EN ISO 717-1						
Stopnja požarne odpornosti		Euroclass A2-s1, d0 skladno z EN 13501-1 Razred A skladno z ASTM E 84						
Odboj svetlobe		88%						
Toplotna prevodnost		$\lambda = 0.060$ W/mk skladno z EN 12667						
Prepustnost zraka		PM1 (≤ 30 m ³ /hm ²) skladno z DIN 18177						
Odpornost proti vlagi		95% RH						
Čisti prostor		ISO 4 skladno z EN ISO 14644-1						
Kakovost zraka		 A+	 E1					
Čiščenje								
Trajnost		 EN ISO 14021	 EN ISO 14025	 EC 1272/2008 Annex 9	 BRONZE			
		35 - 36.9%						

Razpoložljivost izdelkov se lahko razlikuje od države do države.
Za več informacij se obrnite na lokalnega prodajnega predstavnika.
Dodatne in pravne informacije najdete na naši spletni strani.



TEHNIČNI LIST











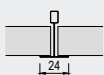
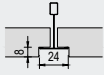
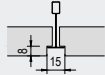















AMF THERMATEX® dB Acoustic



- THERMATEX® dB Acoustic je idealna rešitev za prostore, ki zahtevajo odlično zvočno izolativnost in dobro absorpcijo zvoka. Zagotavlja preprost, a brezčasen dizajn vsakega prostora.
- Dobra zvočna absorpcija (0.65 (H) α_w)
- Odlična vzdolžna zvočna izolativnost (24mm thickness: 41dB - 30mm thickness: 43dB)
- Odlična svetlobna odbojnost (88%)
- ISO 4
- Idealno za pisarne, sejne sobe, učilnice ali hodnike

TEHNIČNI LIST

AMF THERMATEX® dB Acoustic

Oblike robov Drugi robovi po povpraševanju		Board 	Tegular 24/90 	Tegular 15/90 				
Debeline (mm)		24, 30	24	24				
Dimenzije (mm)		600 x 600	600 x 600	600 x 600				
Sistemi		Vidni sistem, snemljive plošče - sistem C						
Teža		8.6 - 10.6 kg / m ²						
Barve		 Bela						
Zvočna absorpcija		EN ISO 354 $\alpha_w = \mathbf{0.65 (H)}$ skladno z EN ISO 11654 - Razred C						
		Frekvenca f (Hz)	125	250	500	1000	2000	4000
		α_p Board (24mm), Tegular 24/90, Tegular 15/90	0.40	0.45	0.60	0.80	0.95	0.95
		α_p Board (30mm)	0.35	0.40	0.65	0.85	0.90	0.95
		NRC = 0.70 skladno z ASTM C 423						
Vzdolžna zvočna izolativnost		EN ISO 10848-2 $D_{n,f,w} = \mathbf{41 dB}$ (24mm) skladno z EN ISO 717-1 CAC = 43 dB (24mm) skladno z ASTM E 413-10		$D_{n,f,w} = \mathbf{43 dB}$ (30mm) skladno z EN ISO 717-1				
Zvočna izolativnost		EN ISO 10140-2 $R_w = \mathbf{24 dB}$ (24mm) skladno z EN ISO 717-1		$R_w = \mathbf{25 dB}$ (30mm) skladno z EN ISO 717-1				
Stopnja požarne odpornosti		Euroclass A2-s1, d0 skladno z EN 13501-1 Razred A skladno z ASTM E 84						
Odboj svetlobe		88%						
Toplotna prevodnost		$\lambda = \mathbf{0.075 W/mk}$ skladno z EN 12667						
Prepustnost zraka		PM1 ($\leq 30 \text{ m}^3/\text{hm}^2$) skladno z DIN 18177						
Odpornost proti vlagi		95% RH						
Čisti prostor		ISO 4 skladno z EN ISO 14644-1						
Kakovost zraka		 A+	 E1					
Čiščenje								
Trajnost		 EN ISO 14025	 EC 1272/2008 Annex G	 EN ISO 14025				
		36.9 - 37%		www.blauer-engel.de/uz132				

Razpoložljivost izdelkov se lahko razlikuje od države do države.
Za več informacij se obrnite na lokalnega prodajnega predstavnika.
Dodatne in pravne informacije najdete na naši spletni strani.







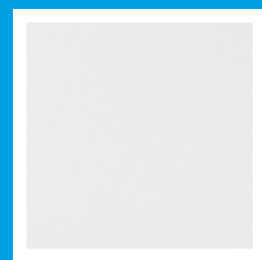





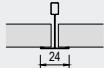
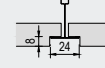

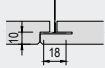
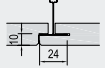















TEHNIČNI LIST

AMF THERMATEX® Alpha HD 19mm



- Plošče AMF THERMATEX® Alpha HD 19mm imajo moderno belo površino in so primerne za prostore, kjer je potrebna odlična zvočna absorpcija in dobra zvočna izolativnost.
- Odlična zvočna absorpcija (0.90 a_w)

- Dobra zvočna izolativnost (34 dB)
- Odlična svetlobna odbojnost (88 %)
- ISO 4
- Primerno za pisarne, izobraževalne prostore, hodnike

Oblike robov Drugi robovi po povpraševanju		Board 	Tegular 24/90 	Tegular 15/90 	SL2 	Finesse 												
Debeline (mm)		19	19	19	19	19												
Dimenzije (mm)		600 x 600 625 x 625 675 x 675 1200 x 300 1200 x 600 1250 x 625 1500 x 600 1800 x 600	600 x 600 625 x 625 675 x 675 1200 x 300 1200 x 600 1250 x 625 1500 x 600 1800 x 600	600 x 600 625 x 625 675 x 675 1200 x 300 1200 x 600 1250 x 625 1350 x 300 1350 x 600 1500 x 600 1800 x 600	1350 x 300 1350 x 600 1500 x 300 1800 x 300 2000 x 300	600 x 600 625 x 625 1200 x 600 1250 x 625												
Sistemi		Vidni sistem, snemljive plošče - sistem C	Vidni sistem, snemljive plošče - sistem C Konstrukcija z vzporednim bandrastrom, vidni ali skriti prečni profil - sistem I.3 Prosto vpeti sistemi, vidni ali zakriti nosilni profili - sistem F.3	Vidni sistem, snemljive plošče - sistem C Konstrukcija z vzporednim bandrastrom, vidni ali skriti prečni profil - sistem I.3 Prosto vpeti sistemi, vidni ali zakriti nosilni profili - sistem F.3	Lamelne snemljive plošče - sistem I.3 Konstrukcija z vzporednim bandrastrom, lamelne snemljive plošče - sistem I.2 Prosto vpeti sistem z zakritimi nosilnimi profili, snemljive plošče - sistem F.2	Skrita podkonstrukcija, snemljive plošče - sistem A2./A.3												
Teža		5.2 kg / m ²																
Barve		 Bela																
Zvočna absorpcija		EN ISO 354 $\alpha_w = 0.90$ skladno z EN ISO 11654 - Razred A Frekvenca f (Hz) <table border="1" style="display: inline-table; vertical-align: middle;"><tr><td>125</td><td>250</td><td>500</td><td>1000</td><td>2000</td><td>4000</td></tr></table> α_p <table border="1" style="display: inline-table; vertical-align: middle;"><tr><td>0.50</td><td>0.70</td><td>0.80</td><td>0.90</td><td>1.00</td><td>1.00</td></tr></table> NRC = 0.85 skladno z ASTM C 423					125	250	500	1000	2000	4000	0.50	0.70	0.80	0.90	1.00	1.00
125	250	500	1000	2000	4000													
0.50	0.70	0.80	0.90	1.00	1.00													
Vzdolžna zvočna izolativnost		EN ISO 10848-2 CAC = 35 dB skladno z ASTM E 413-10 $D_{n,f,w} = 34 \text{ dB}$ skladno z EN ISO 717-1																
Zvočna izolativnost		EN ISO 10140-2 $R_w = 17 \text{ dB}$ skladno z EN ISO 717-1																
Stopnja požarne odpornosti		Euroclass A2-s1, d0 skladno z EN 13501-1																
Odboj svetlobe		88%																
Toplotna prevodnost		$\lambda = 0.060 \text{ W/mk}$ skladno z EN 12667																
Prepustnost zraka		PM1 ($\leq 30 \text{ m}^3/\text{hm}^2$) skladno z DIN 18177																
Odpornost proti vlagi		95% RH																
Čisti prostor		ISO 4 skladno z EN ISO 14644-1																
Kakovost zraka		 A+	 E1															
Čiščenje																		
Trajnost																		
	49.1%	EN ISO 14021	EN ISO 14025	EC 1272/2008 Annex Q	EN ISO 14025	BRONZE												
	www.blauer-engele.de/uz132																	



TEHNIČNI LIST

AMF THERMATEX® Alpha HD 30mm



- Plošče AMF THERMATEX® Alpha HD 30mm nudijo moderen, bel izgled in so optimalna rešitev za prostore, kjer sta potrebna odlična zvočna absorpcija ter zvočna izolacija.
- Odlična zvočna absorpcija ($0.90 \alpha_w$)
- Odlična zvočna izolativnost (40 dB)
- Odlična svetlobna odbojnost (88%)
- ISO 4
- Idealno za pisarne, učilnice, izobraževalne ustanove

TEHNIČNI LIST
AMF THERMATEX® Alpha HD 30mm

Oblike robov Drugi robovi po povpraševanju		Board	Tegular 24/90	Tegular 15/90	SL2	Finesse		
Debeline (mm)		30	30	30	30	30		
Dimenzije (mm)		600 x 600 625 x 625 675 x 675 1200 x 600 1250 x 625	600 x 600 625 x 625 675 x 675 1200 x 600 1250 x 625	600 x 600 625 x 625 675 x 675 1200 x 600 1250 x 625 1350 x 300 1350 x 600	1350 x 300 1350 x 600 1500 x 300 1800 x 300 2000 x 300	600 x 600 625 x 625 1200 x 600 1250 x 625		
Sistemi		Vidni sistem, snemljive plošče - sistem C		Vidni sistem, snemljive plošče - sistem C Konstrukcija z vzporednim bandrastrom, vidni ali skriti prečni profil - sistem I.3 Prosto vpeti sistemi, vidni ali zakriti nosilni profili - sistem F.3	Lamelne snemljive plošče - sistem I.3 Konstrukcija z vzporednim bandrastrom, lamelne snemljive plošče - sistem I.2 Prosto vpeti sistem z zakritimi nosilnimi profili, snemljive plošče - sistem F.2	Skrita podkonstrukcija, snemljive plošče - sistem A2./A.3		
Teža		8.2 kg / m ²						
Barve		 Bela						
Zvočna absorpcija		EN ISO 354 $\alpha_w = 0.90$ skladno z EN ISO 11654 - Razred A						
		Frekvenca f (Hz)	125	250	500	1000	2000	4000
		α_p	0.55	0.70	0.85	1.00	1.00	1.00
		NRC = 0.90 skladno z ASTM C 423						
Vzdolžna zvočna izolativnost		EN ISO 10848-2 $D_{n,f,w} = 40$ dB skladno z EN ISO 717-1						
		CAC = 41 dB skladno z ASTM E 413-10						
Zvočna izolativnost		EN ISO 10140-2 $R_w = 22$ dB skladno z EN ISO 717-1						
Stopnja požarne odpornosti		Euroclass A2-s1, d0 skladno z EN 13501-1						
Odboj svetlobe		88%						
Toplotna prevodnost		$\lambda = 0.060$ W/mk skladno z EN 12667						
Prepustnost zraka		PM1 (≤ 30 m ³ /hm ²) skladno z DIN 18177						
Odpornost proti vlagi		95% RH						
Čisti prostor		ISO 4 skladno z EN ISO 14644-1						
Kakovost zraka								
Čiščenje								
Trajnost								
		49.9%	EN ISO 14025	EC 1272/2008 Annex G		BRONZE	www.blauer-engel.de/uz132	

Razpoložljivost izdelkov se lahko razlikuje od države do države.
Za več informacij se obrnite na lokalnega prodajnega predstavnika.
Dodatne in pravne informacije najdete na naši spletni strani.







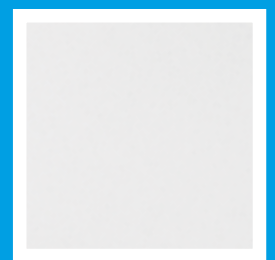







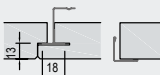



















TEHNIČNI LIST

AMF THERMATEX® Alpha HD 35mm



- Plošče AMF THERMATEX® Alpha HD 35mm nudijo moderen, bel izgled in so optimalna rešitev za prostore, kjer sta potrebna odlična zvočna absorpcija ter zvočna izolacija.
- Odlična zvočna absorpcija ($0.90 \alpha_w$)
- Odlična zvočna izolativnost (42 dB)
- Odlična svetlobna odbojnost (88%)
- ISO 4
- Idealno za pisarne, učilnice, izobraževalne ustanove

Oblike robov Drugi robovi po povpraševanju		Board 	Tegular 24/90 	Tegular 15/90 	SL2 			
Debeline (mm)		35	35	35	35			
Dimenzije (mm)		600 x 600 625 x 625 1200 x 600 1250 x 625	600 x 600 625 x 625 1200 x 600 1250 x 625	600 x 600 625 x 625 1200 x 600 1250 x 625 1350 x 300 1350 x 600	1350 x 300 1350 x 600 1500 x 300 1800 x 300 2000 x 300			
Sistemi		Vidni sistem, snemljive plošče - sistem C	Vidni sistem, snemljive plošče - sistem C Konstrukcija z vzporednim bandrastrom, vidni ali skriti prečni profil - sistem I.3 Prosto vpeti sistemi, vidni ali zakriti nosilni profili - sistem F.3		Lamelne snemljive plošče - sistem I.3 Konstrukcija z vzporednim bandrastrom, lamelne snemljive plošče - sistem I.2 Prosto vpeti sistem z zakritimi nosilnimi profili, snemljive plošče - sistem F.2			
Teža		9.5 kg / m ²						
Barve		 Bela						
Zvočna absorpcija		EN ISO 354 $\alpha_w = 0.90$ skladno z EN ISO 11654 - Razred A						
		Frekvenca f (Hz)	125	250	500	1000	2000	4000
		α_p	0.40	0.65	0.85	1.00	1.00	1.00
		NRC = 0.85 skladno z ASTM C 423						
Vzdolžna zvočna izolativnost		EN ISO 10848-2 $D_{n,f,w} = 42$ dB skladno z EN ISO 717-1 CAC = 44 dB skladno z ASTM E 413-10						
Zvočna izolativnost		EN ISO 10140-2 $R_w = 25$ dB skladno z EN ISO 717-1						
Stopnja požarne odpornosti		Euroclass A2-s1, d0 skladno z EN 13501-1						
Odboj svetlobe		88%						
Toplotna prevodnost		$\lambda = 0.060$ W/mk skladno z EN 12667						
Prepustnost zraka		PM1 (≤ 30 m ³ /hm ²) skladno z DIN 18177						
Odpornost proti vlagi		95% RH						
Čisti prostor		ISO 4 skladno z EN ISO 14644-1						
Kakovost zraka		 A+	 E1					
Čiščenje								
Trajnost		 EN ISO 14021 50.4%	 EN ISO 14025	 BIOSOLUBLE WOOL EC 1272/2008 Annex G	 M1+ EMISION CLASS FOR BUILDING MATERIALS	 cradle to cradle BRONZE		www.blauer-engel.de/uz132



TEHNIČNI LIST











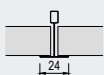
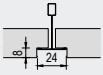
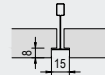

















AMF THERMATEX® Alpha One



- Plošče AMF THERMATEX® Alpha One nudijo moderen bel izgled in so optimalna izbira za prostore, kjer je potrebna najvišja absorpcija zvoka .
- Odlična zvočna absorpcija (1.00 α_w)
- Odlična svetlobna odbojnost (88%)
- ISO 4
- Idealno za pisarne ter izobraževalne prostore

TEHNIČNI LIST

AMF THERMATEX® Alpha One

Oblike robov Drugi robovi po povpraševanju		Board 	Tegular 24/90 	Tegular 15/90 				
Debeline (mm)		24	24	24				
Dimenzije (mm)		600 x 600 625 x 625 1200 x 600	600 x 600 625 x 625 1200 x 600	600 x 600 625 x 625 1200 x 600				
Sistemi		Vidni sistem, snemljive plošče - sistem C						
Teža		4.0 kg / m ²						
Barve		 Bela						
Zvočna absorpcija		EN ISO 354 $\alpha_w = 1.00$ skladno z EN ISO 11654 - Razred A						
		Frekvenca f (Hz)	125	250	500	1000	2000	4000
		α_p	0.55	0.85	1.00	0.95	1.00	1.00
		NRC = 1.00 skladno z ASTM C 423						
Vzdolžna zvočna izolativnost		EN ISO 10848-2 $D_{n,f,w} = 29$ dB skladno z EN ISO 717-1						
Zvočna izolativnost		EN ISO 10140-2 $R_w = 17$ dB skladno z EN ISO 717-1						
Stopnja požarne odpornosti		Euroclass A2-s1, d0 skladno z EN 13501-1 Class A skladno z ASTM E 84						
Odboj svetlobe		88%						
Toplotna prevodnost		$\lambda = 0.040$ W/mk skladno z EN 12667						
Prepustnost zraka		PM1 (≤ 30 m ³ /hm ²) skladno z DIN 18177						
Odpornost proti vlagi		95% RH						
Čisti prostor		ISO 4 skladno z EN ISO 14644-1						
Kakovost zraka		 A+	 E1					
Čiščenje								
Trajnost	 EN ISO 14021 50.8%	 EN ISO 14025	 EC 1272/2008 Annex Q	 M1+	 certified bronze	 www.blauer-engel.de/uz132		

Razpoložljivost izdelkov se lahko razlikuje od države do države.
Za več informacij se obrnite na lokalnega prodajnega predstavnika.
Dodatne in pravne informacije najdete na naši spletni strani.



ARMSTRONG PERLA



- Plošče Armstrong PERLA imajo gladko laminirano belo površino in nudijo uravnotežene akustične lastnosti, dobro zvočno absorpcijo in vzdolžno zvočno izolativnost. Plošče imajo bronasti certifikat C2C.
- Dobra zvočna absorpcija (0.65(H) α_w) in vzdolžna zvočna izolativnost (36 dB)
- Odlična svetlobna odbojnost (88%)
- ISO 5
- Zelo primerno za pisarne in izobraževalne ustanove



ARMSTRONG PERLA

Oblike robov Drugi robovi po povpraševanju		Board 	Tegular 24 	Tegular 15/90 														
Debelina (mm)		17	17	17														
Dimenzije (mm) Druge dimenzije po povpraševanju		600 x 600	600 x 600	600 x 600														
Sistemi		Vidni sistem, snemljive plošče - sistem C																
Teža		4.6 kg / m ²																
Barva		Bela																
Absorpcija zvoka		EN ISO 354 $\alpha_w = \mathbf{0.65(H)}$ skladno z EN ISO 11654 - Class C <table border="1"> <thead> <tr> <th>Frekvenca f (Hz)</th> <th>125</th> <th>250</th> <th>500</th> <th>1000</th> <th>2000</th> <th>4000</th> </tr> </thead> <tbody> <tr> <td>α_p</td> <td>0.40</td> <td>0.45</td> <td>0.60</td> <td>0.80</td> <td>0.90</td> <td>0.90</td> </tr> </tbody> </table> NRC = 0.70 skladno z ASTM C 423			Frekvenca f (Hz)	125	250	500	1000	2000	4000	α_p	0.40	0.45	0.60	0.80	0.90	0.90
Frekvenca f (Hz)	125	250	500	1000	2000	4000												
α_p	0.40	0.45	0.60	0.80	0.90	0.90												
Vzdolžna zvočna izolativnost		EN ISO 10848-2 $D_{n,f,w} = \mathbf{36 dB}$ skladno z EN ISO 717-1																
Zvočna izolativnost		EN ISO 10140-2 $R_w = \mathbf{18 dB}$ skladno z EN ISO 717-1																
Stopnja požarne odpornosti		Euroclass A2-s1, d0 skladno z EN 13501-1	RUS KM1 (G1, V1, D1, T1) skladno z 123-FZ															
Odboj svetlobe		88%																
Toplotna prevodnost		$\lambda = \mathbf{0.060 W/mk}$ skladno z EN 12667																
Prepustnost zraka		PM1 ($\leq 30 m^3/hm^2$) skladno z DIN 18177																
Odpornost proti vlagi		95% RH																
Klasifikacija čistega prostora		ISO 5 skladno z EN ISO 14644-1																
Kakovost zraka		 A+	 E1	 IACG														
Čiščenje																		
Trajnost				   www.blauer-engel.de/uz132														

Razpoložljivost izdelkov se lahko razlikuje od države do države.
 Za več informacij se obrnite na lokalnega prodajnega predstavnika.
 Dodatne in pravne informacije najdete na naši spletni strani.



ARMSTRONG PERLA OP 0.95

- Plošče Armstrong PERLA OP 0.95 imajo gladko belo laminirano površino in nudijo odlično A razred zvočno absorpcijo. Plošče imajo bronasti certifikat C2C.
- Odlična zvočna absorpcija (0.95 α_w)
- Dobra svetlobna odbojnost (85 %)
- ISO 5
- Zelo primerno za odprte pisarne (klicni centri, knjižnice, kavarne, avle...)



ARMSTRONG PERLA OP 0.95

Oblike robov Drugi robovi po povpraševanju		Board 	Tegular 24 	Tegular 15/90 														
Debelina (mm)		15	15	15														
Dimenzije (mm) Druge dimenzije po povpraševanju		600 x 600 675 x 675 1200 x 600	600 x 600 675 x 675 1200 x 600	600 x 600 675 x 675 1200 x 600														
Sistemi		Vidni sistem, snemljive plošče - sistem C																
Teža		2.4 - 2.6 kg/m ²																
Barva		Bela																
Absorpcija zvoka		EN ISO 354 $\alpha_w = 0.95$ skladno z EN ISO 11654 - Class A Frekvenca f (Hz) <table border="1" data-bbox="459 846 1452 929"> <thead> <tr> <th></th> <th>125</th> <th>250</th> <th>500</th> <th>1000</th> <th>2000</th> <th>4000</th> </tr> </thead> <tbody> <tr> <td>α_p Board, Tegular</td> <td>0.45</td> <td>0.80</td> <td>0.95</td> <td>0.90</td> <td>1.00</td> <td>1.00</td> </tr> </tbody> </table> NRC = 0.90 skladno z ASTM C 423				125	250	500	1000	2000	4000	α_p Board, Tegular	0.45	0.80	0.95	0.90	1.00	1.00
	125	250	500	1000	2000	4000												
α_p Board, Tegular	0.45	0.80	0.95	0.90	1.00	1.00												
Vzdolžna zvočna izolativnost		EN ISO 10848-2 $D_{n,f,w} = 25$ dB skladno z EN ISO 717-1																
Zvočna izolativnost		EN ISO 10140-2 $R_w = 12$ dB skladno z EN ISO 717-1																
Stopnja požarne odpornosti		Euroclass A2-s1, d0 skladno z EN 13501-1	RUS KM1 (G1, V1, D1, T1) skladno z 123-FZ															
Odboj svetlobe		85%																
Toplotna prevodnost		$\lambda = 0.040$ W/mk skladno z EN 12667																
Odpornost proti vlagi		95% RH																
Klasifikacija čistega prostora		ISO 5 skladno z EN ISO 14644-1																
Kakovost zraka		 A+	 E1	 IACG														
Čiščenje																		
Trajnost																		
	44 - 66%	EN ISO 14021	EN ISO 14025	EN ISO 14025														

Razpoložljivost izdelkov se lahko razlikuje od države do države.
 Za več informacij se obrnite na lokalnega prodajnega predstavnika.
 Dodatne in pravne informacije najdete na naši spletni strani.



ARMSTRONG PERLA OP 19mm

- Lamelle Armstrong PERLA OP 19 mm ponujajo gladko belo laminirano površino in odlično zvočno absorpcijo A razreda. So izdelane rešitev za hodnike kot tudi za odprte prostore.
- Odlična zvočna absorpcija ($0.90 \alpha_w$) in dobra zvočna izolativnost (34 dB)
- Dobra svetlobna odbojnost (85%)
- ISO 5
- Zelo primerno za odprte prostore (klicni centri, knjižnice, restavracije...) ter za hodnike.



ARMSTRONG PERLA OP 19mm

Oblike robov Drugi robovi po povpraševanju	 Board 	SL2 														
Debelina (mm)	 19	19														
Dimenzije (mm) Druge dimenzije po povpraševanju	 1500 x 600 1800 x 600	1500 x 300 1800 x 300														
Sistemi	 Vidni sistem, snemljive plošče - sistem C	Lamelne snemljive plošče - sistem I.3 Konstrukcija z vzporednim bandrastrom, lamelne snemljive plošče - sistem I.2 Prosto vpeti sistem z zakritimi nosilnimi profili, snemljive plošče - sistem F.2														
Teža	 5.2 kg / m ²															
Barva	 Bela															
Absorpcija zvoka	 EN ISO 354 $\alpha_w = \mathbf{0.90}$ skladno z EN ISO 11654 - Class A <table border="1" data-bbox="467 947 1453 1025"> <thead> <tr> <th>Frekvenca f (Hz)</th> <th>125</th> <th>250</th> <th>500</th> <th>1000</th> <th>2000</th> <th>4000</th> </tr> </thead> <tbody> <tr> <td>α_p</td> <td>0.45</td> <td>0.70</td> <td>0.80</td> <td>0.90</td> <td>1.00</td> <td>1.00</td> </tr> </tbody> </table> NRC = 0.85 skladno z ASTM C 423		Frekvenca f (Hz)	125	250	500	1000	2000	4000	α_p	0.45	0.70	0.80	0.90	1.00	1.00
Frekvenca f (Hz)	125	250	500	1000	2000	4000										
α_p	0.45	0.70	0.80	0.90	1.00	1.00										
Vzdolžna zvočna izolativnost	 EN ISO 10848-2 $D_{n,f,w} = \mathbf{34 dB}$ skladno z EN ISO 717-1															
Stopnja požarne odpornosti	 Euroclass A2-s1, d0 skladno z EN 13501-1	RUS KM1 (G1, V1, D1, T1) skladno z 123-FZ														
Odboj svetlobe	 85%															
Toplotna prevodnost	 $\lambda = \mathbf{0.060 W/mk}$ skladno z EN 12667															
Prepustnost zraka	 PM1 ($\leq 30 m^3/hm^2$) skladno z DIN 18177															
Odpornost proti vlagi	 95% RH															
Klasifikacija čistega prostora	 ISO 5 skladno z EN ISO 14644-1															
Kakovost zraka	  A+  E1  IACG															
Čiščenje	 															
Trajnost	 EN ISO 14021 38%  EN ISO 14025  IC 227/2008 Annex G  M1  <a data-bbox="994 1944 1217 1977" href="http://www.blauer-engel.de/uz132">www.blauer-engel.de/uz132 															

Razpoložljivost izdelkov se lahko razlikuje od države do države.
 Za več informacij se obrnite na lokalnega prodajnega predstavnika.
 Dodatne in pravne informacije najdete na naši spletni strani.

ARMSTRONG PERLA OP 1.00

- Plošče Armstrong PERLA OP 1.00 imajo gladko belo laminirano površino in nudijo odlično zvočno absorpcijo ($1.00 \alpha_w$), zato so odlične za različne odprte prostore. Plošče imajo bronasti certifikat C2C.
- Odlična zvočna absorpcija ($1.00 \alpha_w$)
- Dobra svetlobna odbojnost (85%)
- ISO 4
- Zelo primerno za odprte pisarne (klicni centri, knjižnice, kavarne...)



ARMSTRONG PERLA OP 1.00

Oblike robov Drugi robovi po povpraševanju		Board 	Tegular 24 	Tegular 15/90 														
Debelina (mm)		20	20	20														
Dimenzije (mm) Druge dimenzije po povpraševanju		600 x 600 675 x 675 1200 x 600	600 x 600 675 x 675 1200 x 600	600 x 600 675 x 675 1200 x 600														
Sistemi		Vidni sistem, snemljive plošče - sistem C																
Teža		3.1 kg / m ²																
Barva		Bela																
Absorpcija zvoka		EN ISO 354 $\alpha_w = 1.00$ skladno z EN ISO 11654 - Class A <table border="1"> <thead> <tr> <th>Frekvenca f (Hz)</th> <th>125</th> <th>250</th> <th>500</th> <th>1000</th> <th>2000</th> <th>4000</th> </tr> </thead> <tbody> <tr> <td>α_p</td> <td>0.50</td> <td>0.85</td> <td>0.95</td> <td>0.95</td> <td>1.00</td> <td>1.00</td> </tr> </tbody> </table> NRC = 0.95 skladno z ASTM C 423			Frekvenca f (Hz)	125	250	500	1000	2000	4000	α_p	0.50	0.85	0.95	0.95	1.00	1.00
Frekvenca f (Hz)	125	250	500	1000	2000	4000												
α_p	0.50	0.85	0.95	0.95	1.00	1.00												
Vzdolžna zvočna izolativnost		EN ISO 10848-2 $D_{n,f,w} = 25$ dB skladno z EN ISO 717-1																
Zvočna izolativnost		EN ISO 10140-2 $R_w = 12$ dB skladno z EN ISO 717-1																
Stopnja požarne odpornosti		Euroclass A2-s1, d0 skladno z EN 13501-1	RUS KM1 (G1, V1, D1, T1) skladno z 123-FZ															
Odboj svetlobe		85%																
Toplotna prevodnost		$\lambda = 0.040$ W/mk skladno z EN 12667																
Odpornost proti vlagi		95% RH																
Klasifikacija čistega prostora		ISO 4 skladno z EN ISO 14644-1																
Kakovost zraka		 A+	 E1	 IACG														
Čiščenje																		
Trajnost	 EN ISO 14021 73%	 EN ISO 14025	 ISO 2722008 Annex O	 cradle to cradle BRONZE														

Razpoložljivost izdelkov se lahko razlikuje od države do države.
Za več informacij se obrnite na lokalnega prodajnega predstavnika.
Dodatne in pravne informacije najdete na naši spletni strani.



AMF THERMATEX® Thermofon

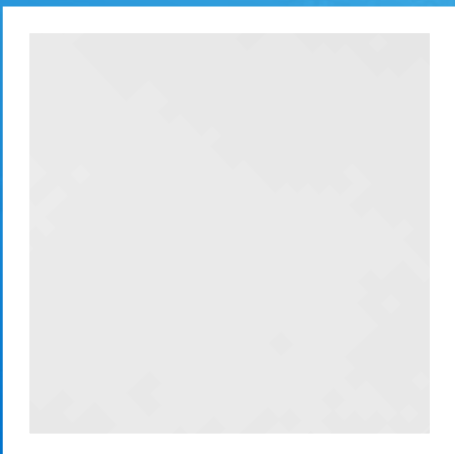

- Plošče AMF THERMATEX® Thermofon zaznamuje gladka bela laminirana površina, ki nudi modern videz. Nudijo zelo dobro zvočno absorpcijo za boljše akustično okolje.
- Visoka zvočna absorpcija (0.80(H) α_w)
- Odlična svetlobna odbojnost (88%)
- ISO 4
- Zelo primerno za pisarne ter učilnice



AMF THERMATEX® THERMOFON

Oblike robov Drugi robovi po povpraševanju		Board 	Tegular 24/90 	Tegular 15/90 														
Debelina (mm)		15	15	15														
Dimenzije (mm) Druge dimenzije po povpraševanju		600 x 600 625 x 625 1200 x 600 1250 x 625	600 x 600 625 x 625 1200 x 600	600 x 600 625 x 625 1200 x 600														
Sistemi		Vidni sistem, snemljive plošče - sistem C																
Teža		2.9 kg / m ²																
Barva		Bela																
Absorpcija zvoka		EN ISO 354 $\alpha_w = \mathbf{0.80 (H)}$ skladno z EN ISO 11654 - Class B <table border="1" data-bbox="459 873 1452 952"> <thead> <tr> <th>Frekvenca f (Hz)</th> <th>125</th> <th>250</th> <th>500</th> <th>1000</th> <th>2000</th> <th>4000</th> </tr> </thead> <tbody> <tr> <td>α_p</td> <td>0.55</td> <td>0.75</td> <td>0.75</td> <td>0.80</td> <td>0.95</td> <td>1.00</td> </tr> </tbody> </table> NRC = 0.85 skladno z ASTM C 423			Frekvenca f (Hz)	125	250	500	1000	2000	4000	α_p	0.55	0.75	0.75	0.80	0.95	1.00
Frekvenca f (Hz)	125	250	500	1000	2000	4000												
α_p	0.55	0.75	0.75	0.80	0.95	1.00												
Vzdolžna zvočna izolativnost		EN ISO 10848-2 $D_{n,f,w} = \mathbf{28 dB}$ skladno z EN ISO 717-1																
Zvočna izolativnost		EN ISO 10140-2 $R_w = \mathbf{13 dB}$ skladno z EN ISO 717-1																
Stopnja požarne odpornosti		Euroclass A2-s1, d0 skladno z EN 13501-1	RUS KM1 (G1, V1, D1, T1) skladno z 123-FZ															
Odboj svetlobe		88%																
Toplotna prevodnost		$\lambda = \mathbf{0.040 W/mk}$ skladno z EN 12667																
Odpornost proti vlagi		95% RH																
Klasifikacija čistega prostora		ISO 4 skladno z EN ISO 14644-1																
Kakovost zraka		 A+	 E1	 IACG														
Čiščenje																		
Trajnost	 EN ISO 14021	 EN ISO 14025	 EC 1272/2008 Annex Q	 M1														
	42%	 www.blauer-engel.de/uz132																

Razpoložljivost izdelkov se lahko razlikuje od države do države.
Za več informacij se obrnite na lokalnega prodajnega predstavnika.
Dodatne in pravne informacije najdete na naši spletni strani.





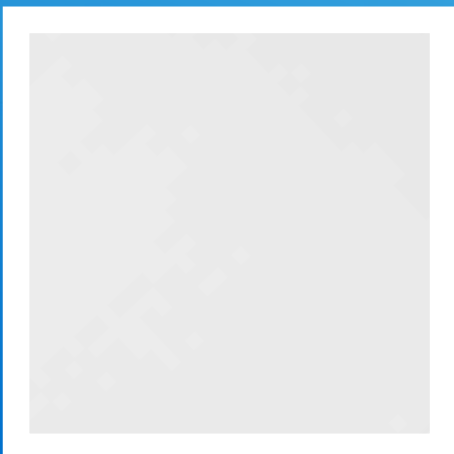







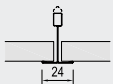
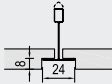
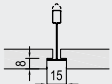













AMF TOPIQ® Prime



- Plošče AMF TOPIQ® Prime so zelo lahke stropne plošče iz kamene volne z moderno gladko belo laminirano površino. Plošče nudijo A razred zvočne absorpcije.
- Odlična zvočna absorpcija (0.95(H) α_w)
- Odlična svetlobna odbojnost (88%)
- ISO 5
- Zelo primerno za pisarne, trgovine, izobraževalne ustanove in podzemne garaže



AMF TOPIQ® PRIME

Oblike robov Drugi robovi po povpraševanju		Board 	Tegular 24/90 	Tegular 15/90 														
Debelina (mm)		15	15	15														
Dimenzije (mm) Druge dimenzije po povpraševanju		600 x 600 625 x 625 1200 x 600 1250 x 625	600 x 600 625 x 625 1200 x 600	600 x 600 625 x 625 1200 x 600														
Sistemi		Vidni sistem, snemljive plošče - sistem C																
Teža		2.1 kg / m ²																
Barva		Bela																
Absorpcija zvoka		EN ISO 354 $\alpha_w = 0.95$ skladno z EN ISO 11654 - Class A <table border="1"> <thead> <tr> <th>Frekvenca f (Hz)</th> <th>125</th> <th>250</th> <th>500</th> <th>1000</th> <th>2000</th> <th>4000</th> </tr> </thead> <tbody> <tr> <td>α_p</td> <td>0.50</td> <td>0.85</td> <td>0.95</td> <td>0.90</td> <td>1.00</td> <td>1.00</td> </tr> </tbody> </table> NRC = 0.90 skladno z ASTM C 423			Frekvenca f (Hz)	125	250	500	1000	2000	4000	α_p	0.50	0.85	0.95	0.90	1.00	1.00
Frekvenca f (Hz)	125	250	500	1000	2000	4000												
α_p	0.50	0.85	0.95	0.90	1.00	1.00												
Vzdolžna zvočna izolativnost		EN ISO 10848-2 $D_{n,f,w} = 24$ dB skladno z EN ISO 717-1																
Zvočna izolativnost		EN ISO 10140-2 $R_w = 13$ dB skladno z EN ISO 717-1																
Stopnja požarne odpornosti		Euroclass A1 skladno z EN 13501-1	RUS KM2 (G1, V1, D1, T1) skladno z 123-FZ															
Odboj svetlobe		88%																
Odpornost proti vlagi		100% RH																
Klasifikacija čistega prostora		ISO 5 skladno z EN ISO 14644-1																
Kakovost zraka		 A	 E1	 IAC														
Čiščenje																		
Trajnost	 EN ISO 14021 32-33%	 BIOSOLUBLE WOOL EC 1272/2008 Annex Q	 M1 EMISION CLASS FOR BUILDING MATERIALS	 www.blauer-engel.de/uz132														

Razpoložljivost izdelkov se lahko razlikuje od države do države.
Za več informacij se obrnite na lokalnega prodajnega predstavnika.
Dodatne in pravne informacije najdete na naši spletni strani.



AMF TOPIQ® Efficient Pro

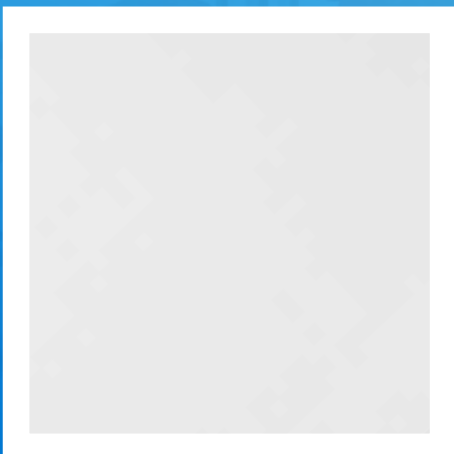

- AMF TOPIQ® Efficient Pro so zelo lahke plošče iz kamene volne z moderno gladko laminirano površino. Nudijo A razred zvočne absorpcije in so primerne za prostore s 100 % relativno zračno vlažnostjo.
- Odlična zvočna absorpcija (1.00(H) α_w)
- Odlična svetlobna odbojnost (88%)
- ISO 4
- Zelo primerno za pisarne, učilnice, vzgojno varstvene ustanove in podzemne garaže



Oblike robov Drugi robovi po povpraševanju		Board 	Tegular 24/90 	Tegular 15/90 														
Debelina (mm)		20	20	20														
Dimenzije (mm) Druge dimenzije po povpraševanju		600 x 600 625 x 625 1200 x 600	600 x 600 625 x 625 1200 x 600	600 x 600 625 x 625 1200 x 600														
Sistemi		Vidni sistem, snemljive plošče - sistem C																
Teža		2.8 kg / m ²																
Barva		Bela																
Absorpcija zvoka		EN ISO 354 $\alpha_w = 1.00$ skladno z EN ISO 11654 - Class A <table border="1"> <thead> <tr> <th>Frekvenca f (Hz)</th> <th>125</th> <th>250</th> <th>500</th> <th>1000</th> <th>2000</th> <th>4000</th> </tr> </thead> <tbody> <tr> <td>α_p</td> <td>0.45</td> <td>0.90</td> <td>1.00</td> <td>0.95</td> <td>1.00</td> <td>1.00</td> </tr> </tbody> </table> NRC = 0.95 skladno z ASTM C 423			Frekvenca f (Hz)	125	250	500	1000	2000	4000	α_p	0.45	0.90	1.00	0.95	1.00	1.00
Frekvenca f (Hz)	125	250	500	1000	2000	4000												
α_p	0.45	0.90	1.00	0.95	1.00	1.00												
Vzdolžna zvočna izolativnost		EN ISO 10848-2 $D_{n,f,w} = 25 \text{ dB}$ skladno z EN ISO 717-1																
Zvočna izolativnost		EN ISO 10140-2 $R_w = 15 \text{ dB}$ skladno z EN ISO 717-1																
Stopnja požarne odpornosti		Euroclass A1 skladno z EN 13501-1	RUS KM2 (G1, V1, D1, T1) skladno z 123-FZ															
Odboj svetlobe		88%																
Odpornost proti vlagi		100% RH																
Klasifikacija čistega prostora		ISO 4 skladno z EN ISO 14644-1																
Kakovost zraka		 A	 E1	 IAC														
Čiščenje																		
Trajnost		 33%		 www.blauer-engel.de/uz132														

Razpoložljivost izdelkov se lahko razlikuje od države do države.
 Za več informacij se obrnite na lokalnega prodajnega predstavnika.
 Dodatne in pravne informacije najdete na naši spletni strani.

Zdravstvo & Higijena

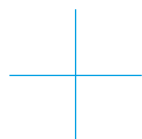



UNDER CONSTANT SCRUTINY AND DEMANDING THE HIGHEST LEVELS OF COMFORT AND CLEANLINESS, HEALTHCARE SETTINGS GO THROUGH CONTINUAL CHANGES TO ENSURE THE BEST POSSIBLE ENVIRONMENT FOR PATIENTS AND HEALTHCARE PROFESSIONALS.

Reaching the essential criteria for individual risk zones, our easy-to-clean products deliver a strong acoustic performance, with impressive sound-absorbing and sound-blocking properties to help create privacy, as well as bring in daylight to reduce in-patient time.













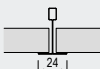

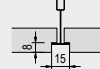

















TEHNIČNI LIST

MEDIGUARD Alpha



MEDIGUARD Alpha ima vrhunsko protimikrobno odpornost. Primeren za aplikacije v zdravstvu, ki zahtevajo absorpcijo zvoka razreda A in stroge metode čiščenja, lahko se drgne, čisti s paro, je odporen na praske ter je vodoodbojen.

- Vodoodbojno
- Odporno na praske
- Preprečuje rast razširjenemu obsegu bakterij in gliv
- Odporen na razkužila, lahko se drgne s krpo in čistiti s paro
- Skladen z zahtevami glede tveganja cone 4 v skladu z NF S 90-351:2013
- Odlična zvočna absorpcija razreda A
- ISO 3
- Odlična svetlobna odbojnost (88%)
- Idealno za zdravstvene ustanove, prehrambeno industrijo, laboratorije itd.

Oblike robov		Board 	Tegular 24/90 	Tegular 15/90 				
Debeline (mm)		20	20	20				
Dimenzije (mm)		600 x 600 1200 x 600	600 x 600	600 x 600				
Sistemi		Vidni sistem, snemljive plošče - sistem C						
Teža		3.3 kg / m ²						
Barve		 Bela						
Zvočna absorpcija		EN ISO 354 $\alpha_w = 0.95$ skladno z EN ISO 11654 - Razred A						
		Frekvenca f (Hz)	125	250	500	1000	2000	4000
		α_p	0.60	0.85	0.90	0.90	1.00	1.00
		NRC = 0.95 skladno z ASTM C 423						
Vzdolžna zvočna izolativnost		EN ISO 10848-2 $D_{n,f,w} = 25$ dB skladno z EN ISO 717-1			CAC = 25 dB skladno z ASTM E 413-10			
Zvočna izolativnost		EN ISO 10140-2 $R_w = 12$ dB skladno z EN ISO 717-1						
Stopnja požarne odpornosti		Euroclass A2-s1, d0 skladno z EN 13501-1 Razred A skladno z ASTM E 84						
Odboj svetlobe		88%						
Toplotna prevodnost		$\lambda = 0.040$ W/mk skladno z EN 12667						
Odpornost proti vlagi		95% RH						
Čisti prostor		ISO 3 skladno z EN ISO 14644-1						
Stopnja tveganja		Cona 4 (Very High Risk) skladno z NF S 90-351:2013						
Mikrobiološka čistost		M1 skladno z NF S 90-351:2013						
Kinetika dekontaminacije delcev		CP_(0,5)5 skladno z NF S 90-351:2013						
Kakovost zraka		 A+	 E1					
Čiščenje								
Antimikrobne lastnosti		Testirano proti: Escherichia coli, Staphylococcus aureus, Bacillus cereus, Streptococcus pneumoniae, Acinobacter baumannii, Klebsiella pneumoniae, Candida albicans, Aspergillus brasiliensis						
Trajnost		 EN ISO 14021 74%	 BIOSOLUBLE WOOL EC 1272/2008 Annex 0					

Poleg stopnje tveganja ima lahko vsak prostor posebne zahteve glede možnosti čiščenja in prepuščanja zraka stropne plošče. Zato ni nujno, da plošča, ki ustreza zahtevam za območje tveganja 4, da ustreza za vse prostore opredeljenih v coni tveganja 4.



TEHNIČNI LIST

MEDIGUARD Acoustic











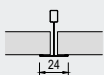
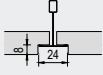
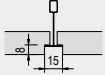





















MEDIGUARD Acoustic združuje odlično možnost čiščenja in dobro absorpcijo zvoka. Zaradi njegove vrhunske protimikrobne učinkovitosti in odpornosti na razkužila ter odpornosti proti praskam in voodobojnosti je idealna rešitev za uporabo v zdravstvu.

- Voodobojno
- Odpornost na praske
- Preprečuje rast razširjenemu obsegu bakterij in gliv
- Odporen na razkužila, lahko se drgne s krpo in čistiti s paro
- Skladen z zahtevami glede tveganja cone 4 v skladu z NF S 90-351:2013
- Odlična svetlobna odbojnost (88%)
- Idealno za zdravstvene ustanove, prehrambeno industrijo, laboratorije itd.

TEHNIČNI LIST

MEDIGUARD Acoustic

Oblike robov		Board 	Tegular 24/90 	Tegular 15/90 				
Debeline (mm)		19	19	19				
Dimenzije (mm)		600 x 600 1200 x 600	600 x 600 1200 x 600	600 x 600 1200 x 600				
Sistemi		Vidni sistem, snemljive plošče - sistem C						
Teža		5.0 kg / m ²						
Barve		 Bela						
Zvočna absorpcija		EN ISO 354 $\alpha_w = \mathbf{0.65(H)}$ skladno z EN ISO 11654 - Razred C						
		Frekvenca f (Hz)	125	250	500	1000	2000	4000
		α_p	0.40	0.40	0.60	0.80	0.90	0.85
		NRC = 0.70 skladno z ASTM C 423						
Vzdolžna zvočna izolativnost		EN ISO 10848-2 $D_{n,f,w} = \mathbf{38 dB}$ skladno z EN ISO 717-1		CAC = 39 dB skladno z ASTM E 413-10				
Zvočna izolativnost		EN ISO 10140-2 $R_w = \mathbf{22 dB}$ skladno z EN ISO 717-1						
Stopnja požarne odpornosti		Euroclass A2-s1, d0 skladno z EN 13501-1 Razred A skladno z ASTM E 84						
Odboj svetlobe		88%						
Toplotna prevodnost		$\lambda = \mathbf{0.060 W/mk}$ skladno z EN 12667						
Prepustnost zraka		PM1 ($\leq 30 \text{ m}^3/\text{hm}^2$) skladno z DIN 18177						
Odpornost proti vlagi		95% RH						
Čisti prostor		ISO 4 skladno z EN ISO 14644-1						
Stopnja tveganja		Cona 4 (Very High Risk) skladno z NF S 90-351:2013						
Mikrobiološka čistost		M1 skladno z NF S 90-351:2013						
Kinetika dekontaminacije delcev		CP_(0,5)5 skladno z NF S 90-351:2013						
Kakovost zraka								
Čiščenje								
Antimikrobne lastnosti		Testirano proti: Escherichia coli, Staphylococcus aureus, Bacillus cereus, Streptococcus pneumoniae, Acinobacter baumannii, Klebsiella pneumoniae, Candida albicans, Aspergillus brasiliensis						
Trajnost								
		35%						

Poleg stopnje tveganja ima lahko vsak prostor posebne zahteve glede možnosti čiščenja in prepuščanja zraka stropne plošče. Zato ni nujno, da plošča, ki ustreza zahtevam za območje tveganja 4, da ustreza za vse prostore opredeljenih v coni tveganja 4.

Razpoložljivost izdelkov se lahko razlikuje od države do države.
Za več informacij se obrnite na lokalnega prodajnega predstavnika.
Dodatne in pravne informacije najdete na naši spletni strani.



TEHNIČNI LIST

MEDIGUARD Plain

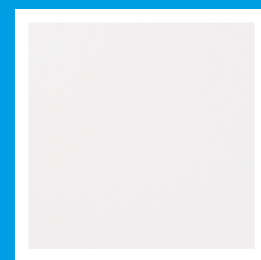





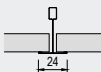
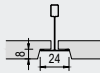

MEDIGUARD Plain združuje dobro čiščenje in vrhunsko protimikrobno odpornost, zaradi česar je idealna rešitev za zdravstvena okolja.

- Vodoodbojen
- Odpornost na praske
- Omeji rast razširjenega obsega bakterij in gliv
- Odporno na dezinfekcijska sredstva. Lahko se čisti s suho, vlažno ali mokro krpo
- Skladen z zahtevami glede tveganja cone 4 v skladu z NF S 90-351:2013
- ISO 4
- Odlična svetlobna odbojnost (88%)
- Idealno za zdravstvene prostore ter laboratorije

TEHNIČNI LIST

MEDIGUARD Plain

Oblike robov		Board 	Tegular 24 	Tegular 15 				
Debeline (mm)		15	15	15				
Dimenzije (mm)		600 x 600 1200 x 600	600 x 600	600 x 600				
Sistemi		Vidni sistem, snemljive plošče - sistem C						
Teža		3.6 kg / m ²						
Barve		 Bela						
Zvočna absorpcija		EN ISO 354 $\alpha_w = \mathbf{0.20 (L)}$ skladno z EN ISO 11654 - Razred E						
		Frekvenca f (Hz)	125	250	500	1000	2000	4000
		α_p	0.40	0.25	0.15	0.15	0.20	0.30
		NRC = 0.20 skladno z ASTM C 423						
Vzdolžna zvočna izolativnost		EN ISO 10848-2 $D_{n,f,w} = \mathbf{35 dB}$ skladno z EN ISO 717-1 CAC = 35 dB skladno z ASTM E 413-10						
Zvočna izolativnost		EN ISO 10140-2 $R_w = \mathbf{19 dB}$ skladno z EN ISO 717-1						
Stopnja požarne odpornosti		Euroclass A2-s1, d0 skladno z EN 13501-1 Razred A skladno z ASTM E 84						
Odboj svetlobe		88%						
Toplotna prevodnost		$\lambda = \mathbf{0.060 W/mk}$ skladno z EN 12667						
Prepustnost zraka		PM1 ($\leq 30 \text{ m}^3/\text{hm}^2$) skladno z DIN 18177						
Odpornost proti vlagi		95% RH						
Čisti prostor		ISO 4 skladno z EN ISO 14644-1						
Stopnja tveganja		Cona 4 (Very High Risk) skladno z NF S 90-351:2013						
Mikrobiološka čistost		M1 skladno z NF S 90-351:2013						
Kinetika dekontaminacije delcev		CP_(0,5)5 skladno z NF S 90-351:2013						
Kakovost zraka		 A+	 E1					
Čiščenje								
Antimikrobne lastnosti		Testirano proti: Escherichia coli, Staphylococcus aureus, Bacillus cereus, Streptococcus pneumoniae, Acinobacter baumannii, Klebsiella pneumoniae, Candida albicans, Aspergillus brasiliensis						
Trajnost		 EN ISO 14021 24%	 BIOSOLUBLE WOOL EC 1272/2008 Annex G					

Poleg stopnje tveganja ima lahko vsak prostor posebne zahteve glede možnosti čiščenja in prepuščanja zraka stropne plošče. Zato ni nujno, da plošča, ki ustreza zahtevam za območje tveganja 4, da ustreza za vse prostore opredeljenih v coni tveganja 4.



TEHNIČNI LIST

HYGENA Aquatec











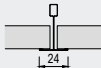
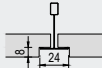
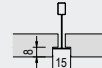
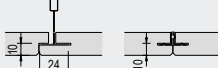

















HYGENA Aquatec je idealna rešitev za prostore z visoko vlažnostjo do 100 % RH. Ponuja odlično absorpcijo zvoka in možnost pranja, zaradi česar je odlična rešitev za higienska in zdravstvena okolja. Površina je pralna in protimikrobna.

- Preprečuje rast bakterij in gljiv
- Idealna rešitev za prostore z visoko vlažnostjo do 100 % RH
- Odlična zvočna absorpcija razreda A
- Skladen z zahtevami glede tveganja cone 4 v skladu z NF S 90-351:2013
- Lahko se čisti pod visokim tlakom in je odporen na dezinfekcijska sredstva
- ISO 3
- Idealno za zdravstvene ustanove, prehrabeno industrijo, laboratorije, sobe za okrevanje, oddelki za intenzivno nego, garderobe in tuši.

TEHNIČNI LIST

HYGENA Aquatec

Oblike robov		Board 	Tegular 24/90 	Tegular 15/90 	Finesse 			
Debeline (mm)		19	19	19	19			
Dimenzije (mm)		600 x 600 610 x 610 625 x 625 1200 x 600 1220 x 610 1250 x 625	600 x 600 610 x 610 625 x 625	600 x 600 610 x 610 625 x 625	600 x 600 625 x 625			
Sistemi		Vidni sistem, snemljive plošče - sistem C			Skrita podkonstrukcija, snemljive plošče - sistem A2./A.3			
Teža		5.2 kg / m ²						
Barve		 Bela						
Zvočna absorpcija		EN ISO 354 Frekvenca f (Hz)						
		125	250	500	1000	2000	4000	
		α_p	0.60	0.70	0.85	0.90	1.00	1.00
		NRC = 0.90 skladno z ASTM C 423						
Vzdolžna zvočna izolativnost		EN ISO 10848-2 $D_{n,f,w}$ = 29 dB skladno z EN ISO 717-1				CAC = 29 dB skladno z ASTM E 413-10		
Zvočna izolativnost		EN ISO 10140-2 R_w = 16 dB skladno z EN ISO 717-1						
Stopnja požarne odpornosti		Euroclass A2-s1, d0 skladno z EN 13501-1 Razred A skladno z ASTM E 84						
Odboj svetlobe		88%						
Toplotna prevodnost		λ = 0.060 W/mk skladno z EN 12667						
Prepustnost zraka		PM1 (≤ 30 m ³ /hm ²) skladno z DIN 18177						
Odpornost proti vlagi		100% RH						
Čisti prostor		ISO 3 skladno z EN ISO 14644-1						
Stopnja tveganja		Cona 4 (Very High Risk) skladno z NF S 90-351:2013						
Mikrobiološka čistost		M1 skladno z NF S 90-351:2013						
Kinetika dekontaminacije delcev		CP_(0,5)5 skladno z NF S 90-351:2013						
Kakovost zraka		 A+	 E1					
Čiščenje								
Antimikrobne lastnosti		Testirano proti: Escherichia coli, Staphylococcus aureus, Candida albicans						
Trajnost		 EN ISO 14021	 BIOSOLUBLE WOOL EC 1272/2008 Annex G					

Poleg stopnje tveganja ima lahko vsak prostor posebne zahteve glede možnosti čiščenja in prepuščanja zraka stropne plošče. Zato ni nujno, da plošča, ki ustreza zahtevam za območje tveganja 4, da ustreza za vse prostore opredeljenih v coni tveganja 4.

Razpoložljivost izdelkov se lahko razlikuje od države do države.
Za več informacij se obrnite na lokalnega prodajnega predstavnika.
Dodatne in pravne informacije najdete na naši spletni strani.













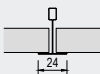

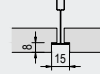

















TEHNIČNI LIST

MEDIGUARD Alpha



MEDIGUARD Alpha ima vrhunsko protimikrobno odpornost. Primeren za aplikacije v zdravstvu, ki zahtevajo absorpcijo zvoka razreda A in stroge metode čiščenja, lahko se drgne, čisti s paro, je odporen na praske ter je vodoodbojen.

- Vodoodbojno
- Odporno na praske
- Preprečuje rast razširjenemu obsegu bakterij in gliv
- Odporen na razkužila, lahko se drgne s krpo in čistiti s paro
- Skladen z zahtevami glede tveganja cone 4 v skladu z NF S 90-351:2013
- Odlična zvočna absorpcija razreda A
- ISO 3
- Odlična svetlobna odbojnost (88%)
- Idealno za zdravstvene ustanove, prehrambeno industrijo, laboratorije itd.

Oblike robov		Board 	Tegular 24/90 	Tegular 15/90 				
Debeline (mm)		20	20	20				
Dimenzije (mm)		600 x 600 1200 x 600	600 x 600	600 x 600				
Sistemi		Vidni sistem, snemljive plošče - sistem C						
Teža		3.3 kg / m ²						
Barve		 Bela						
Zvočna absorpcija		EN ISO 354 $\alpha_w = 0.95$ skladno z EN ISO 11654 - Razred A						
		Frekvenca f (Hz)	125	250	500	1000	2000	4000
		α_p	0.60	0.85	0.90	0.90	1.00	1.00
		NRC = 0.95 skladno z ASTM C 423						
Vzdolžna zvočna izolativnost		EN ISO 10848-2 $D_{n,f,w} = 25$ dB skladno z EN ISO 717-1			CAC = 25 dB skladno z ASTM E 413-10			
Zvočna izolativnost		EN ISO 10140-2 $R_w = 12$ dB skladno z EN ISO 717-1						
Stopnja požarne odpornosti		Euroclass A2-s1, d0 skladno z EN 13501-1 Razred A skladno z ASTM E 84						
Odboj svetlobe		88%						
Toplotna prevodnost		$\lambda = 0.040$ W/mk skladno z EN 12667						
Odpornost proti vlagi		95% RH						
Čisti prostor		ISO 3 skladno z EN ISO 14644-1						
Stopnja tveganja		Cona 4 (Very High Risk) skladno z NF S 90-351:2013						
Mikrobiološka čistost		M1 skladno z NF S 90-351:2013						
Kinetika dekontaminacije delcev		CP_(0,5)5 skladno z NF S 90-351:2013						
Kakovost zraka		 A+	 E1					
Čiščenje								
Antimikrobne lastnosti		Testirano proti: Escherichia coli, Staphylococcus aureus, Bacillus cereus, Streptococcus pneumoniae, Acinobacter baumannii, Klebsiella pneumoniae, Candida albicans, Aspergillus brasiliensis						
Trajnost		 EN ISO 14021 74%	 BIOSOLUBLE WOOL EC 1272/2008 Annex 0					

Poleg stopnje tveganja ima lahko vsak prostor posebne zahteve glede možnosti čiščenja in prepuščanja zraka stropne plošče. Zato ni nujno, da plošča, ki ustreza zahtevam za območje tveganja 4, da ustreza za vse prostore opredeljenih v coni tveganja 4.







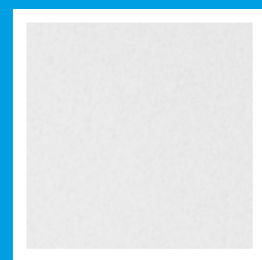





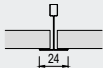
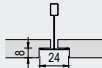
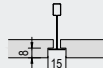













TEHNIČNI LIST

HYGENA Acoustic 15mm



Laminirana površina HYGENA Acoustic ustvarja gladek, bel videz. Zagotavlja dobro absorpcijo zvoka. Površina je pralna in protimikrobna.

- Preprečuje rast bakterij in gljiv
- Lahko se čisti s shuho ali vlažno krpo
- Bela gladka površina z dobrimi akustičnimi lastnostmi
- Skladen z zahtevami glede tveganja cone 4 v skladu z NF S 90-351:2013
- Odlična svetlobna odbojnost (87%)
- Idealno za zdravstvene ustanove, prehrambeno industrijo, laboratorije...

Oblike robov		Board 	Tegular 24/90 	Tegular 15/90 				
Debeline (mm)		15	15	15				
Dimenzije (mm)		600 x 600 610 x 610 625 x 625 1200 x 600 1220 x 610 1250 x 625	600 x 600 610 x 610 625 x 625	600 x 600 610 x 610 625 x 625				
Sistemi		Vidni sistem, snemljive plošče - sistem C						
Teža		2.9 kg / m ²						
Barve		 Bela						
Zvočna absorpcija		EN ISO 354 $\alpha_w = 0.80$ (H) skladno z EN ISO 11654 - Razred B						
		Frekvenca f (Hz)	125	250	500	1000	2000	4000
		α_p	0.55	0.75	0.80	0.75	0.95	1.00
		NRC = 0.85 skladno z ASTM C 423						
Vzdolžna zvočna izolativnost		EN ISO 10848-2 $D_{n,f,w} = 28$ dB skladno z EN ISO 717-1 CAC = 29 dB skladno z ASTM E 413-10						
Zvočna izolativnost		EN ISO 10140-2 $R_w = 13$ dB skladno z EN ISO 717-1						
Stopnja požarne odpornosti		Euroclass A2-s1, d0 skladno z EN 13501-1 Razred A skladno z ASTM E 84						
Odboj svetlobe		87%						
Toplotna prevodnost		$\lambda = 0.040$ W/mk skladno z EN 12667						
Odpornost proti vlagi		95% RH						
Čisti prostor		ISO 4 skladno z EN ISO 14644-1						
Stopnja tveganja		Cona 4 (Very High Risk) skladno z NF S 90-351:2013						
Mikrobiološka čistost		M1 skladno z NF S 90-351:2013						
Kinetika dekontaminacije delcev		CP_(0,5)5 skladno z NF S 90-351:2013						
Kakovost zraka		 A+	 E1					
Čiščenje								
Antimikrobne lastnosti		Testirano proti: Escherichia coli, Staphylococcus aureus, Candida albicans, Aspergillus niger						
Trajnost		 EN ISO 14021 48%	 BIOSOLUBLE WOOL EC 1272/2008 Annex G					

Poleg stopnje tveganja ima lahko vsak prostor posebne zahteve glede možnosti čiščenja in prepuščanja zraka stropne plošče. Zato ni nujno, da plošča, ki ustreza zahtevam za območje tveganja 4, da ustreza za vse prostore opredeljenih v coni tveganja 4.



TEHNIČNI LIST

HYGENA Plain

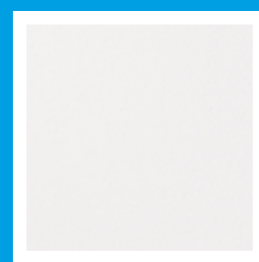









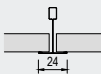
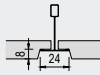
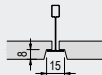















HYGENA Plain ponuja gladko belo površino, ki ustvarja eleganten izgled in nudi dobro svetlobno odbojnost. Površina se lahko čisti in je antimikrobna.

- Preprečuje rast bakterij in gljiv
- Lahko se čisti s suho ali vlažno krpo
- Bela gladka površina za odlično svetlobno odbojnost
- Skladen z zahtevami glede tveganja cone 4 v skladu z NF S 90-351:2013
- Idealno za zdravstvene ustanove in laboratorije

TEHNIČNI LIST

HYGENA Plain

Oblike robov		Board 	Tegular 24 	Tegular 15 				
Debeline (mm)		15	15	15				
Dimenzije (mm)		600 x 600 610 x 610 1200 x 600 1220 x 610	600 x 600	600 x 600				
Sistemi		Vidni sistem, snemljive plošče - sistem C						
Teža		3.8 kg / m ²						
Barve		 Bela						
Zvočna absorpcija		EN ISO 354 $\alpha_w = 0.20$ (L) skladno z EN ISO 11654 - Razred E						
		Frekvenca f (Hz)	125	250	500	1000	2000	4000
		α_p	0.45	0.25	0.15	0.15	0.20	0.25
		NRC = 0.20 skladno z ASTM C 423						
Vzdolžna zvočna izolativnost		EN ISO 10848-2 $D_{n,f,w} = 34$ dB skladno z EN ISO 717-1		CAC = 36 dB skladno z ASTM E 413-10				
Zvočna izolativnost		EN ISO 10140-2 $R_w = 21$ dB skladno z EN ISO 717-1						
Stopnja požarne odpornosti		Euroclass A2-s1, d0 skladno z EN 13501-1 Razred A skladno z ASTM E 84						
Odboj svetlobe		87%						
Toplotna prevodnost		$\lambda = 0.060$ W/mk skladno z EN 12667						
Prepustnost zraka		PM1 (≤ 30 m ³ /hm ²) skladno z DIN 18177						
Odpornost proti vlagi		95% RH						
Čisti prostor		ISO 4 skladno z EN ISO 14644-1						
Stopnja tveganja		Cona 4 (Very High Risk) skladno z NF S 90-351:2013						
Mikrobiološka čistost		M1 skladno z NF S 90-351:2013						
Kinetika dekontaminacije delcev		CP_(0,5)5 skladno z NF S 90-351:2013						
Kakovost zraka		 A+	 E1					
Čiščenje								
Antimikrobne lastnosti		Testirano proti: Escherichia coli, Staphylococcus aureus, Candida albicans, Aspergillus niger						
Trajnost		 EN ISO 14021 26%	 BIOSOLUBLE WOOL EC 1272/2008 Annex G					

Poleg stopnje tveganja ima lahko vsak prostor posebne zahteve glede možnosti čiščenja in prepuščanja zraka stropne plošče. Zato ni nujno, da plošča, ki ustreza zahtevam za območje tveganja 4, da ustreza za vse prostore opredeljenih v coni tveganja 4.

Razpoložljivost izdelkov se lahko razlikuje od države do države.
Za več informacij se obrnite na lokalnega prodajnega predstavnika.
Dodatne in pravne informacije najdete na naši spletni strani.



AMF THERMATEX® Aquatec

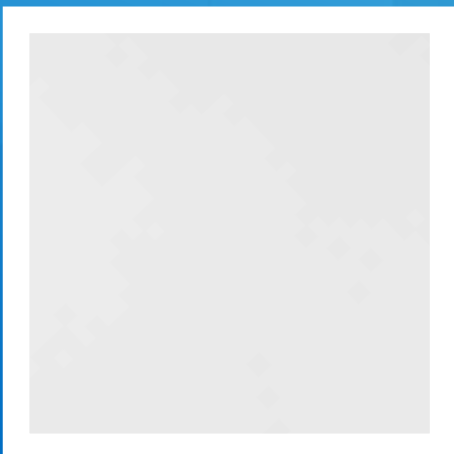

- Plošče AMF THERMATEX® Aquatec so idealna rešitev za prostore, kjer se pojavlja 100 % relativna zračna vlažnost. Nudijo odlično zvočno absorpcijo in lahko se čistijo z vodo pod visokim tlakom. Zaradi visoke kvalitete so zelo primerne za higienske in zdravstvene prostore.
- Odlična zvočna absorpcija (0.90 α_w)
- Odlična svetlobna odbojnost (88%)
- ISO 3
- Zelo primerno za zdravstvene ustanove, laboratorije, garderobe, bazene



Oblike robov Drugi robovi po povpraševanju		Board 	Tegular 24/90 	Tegular 15/90 	Finesse 														
Debelina (mm)		19	19	19	19														
Dimenzije (mm) Druge dimenzije po povpraševanju		600 x 600 625 x 625	600 x 600 625 x 625	600 x 600 625 x 625	600 x 600 625 x 625														
Sistemi		Vidni sistem, snemljive plošče - sistem C			Zakriti sistem, snemljive plošče - sistem A2														
Teža		5.2 kg / m ²																	
Barva		Bela																	
Absorpcija zvoka		EN ISO 354 $\alpha_w = 0.90$ skladno z EN ISO 11654 - Class A <table border="1"> <thead> <tr> <th>Frekvenca f (Hz)</th> <th>125</th> <th>250</th> <th>500</th> <th>1000</th> <th>2000</th> <th>4000</th> </tr> </thead> <tbody> <tr> <td>α_p</td> <td>0.60</td> <td>0.70</td> <td>0.85</td> <td>0.90</td> <td>1.00</td> <td>1.00</td> </tr> </tbody> </table> NRC = 0.90 skladno z ASTM C 423				Frekvenca f (Hz)	125	250	500	1000	2000	4000	α_p	0.60	0.70	0.85	0.90	1.00	1.00
Frekvenca f (Hz)	125	250	500	1000	2000	4000													
α_p	0.60	0.70	0.85	0.90	1.00	1.00													
Vzdolžna zvočna izolativnost		EN ISO 10848-2 $D_{n,f,w} = 29$ dB skladno z EN ISO 717-1																	
Zvočna izolativnost		EN ISO 10140-2 $R_w = 16$ dB skladno z EN ISO 717-1																	
Stopnja požarne odpornosti		Euroclass A2-s1, d0 skladno z EN 13501-1		RUS KM1 (G1, V1, D1, T1) skladno z 123-FZ															
Odboj svetlobe		88%																	
Toplotna prevodnost		$\lambda = 0.060$ W/mk skladno z EN 12667																	
Prepustnost zraka		PM1 (≤ 30 m ³ /hm ²) skladno z DIN 18177																	
Odpornost proti vlagi		100% RH																	
Klasifikacija čistega prostora		ISO 3 skladno z EN ISO 14644-1																	
Kakovost zraka		 A+	 E1	 IACG															
Čiščenje																			
Trajnost		 EN ISO 14021 35%	 EN ISO 14025	 EC 1272/2008 Annex Q	 www.blauer-engel.de/uz132														





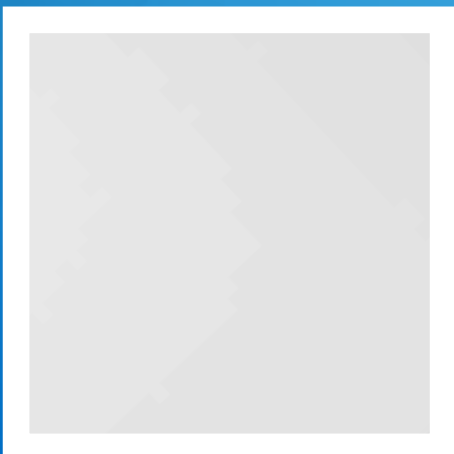







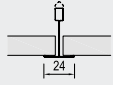











AMF THERMATEX® Thermaclean



- Plošče AMF THERMATEX® Thermaclean združujejo odlično možnost čiščenja ter odpornost proti bakterijam ter gljivam. Površina je laminirana z belo vinilno folijo, ki zagotavlja brezčasen videz.
- Dobra vzdolžna zvočna izolativnost (34 dB)
- ISO 4
- Primerno za zdravstvene ustanove, laboratorije, operacijske sobe.



AMF THERMATEX® THERMACLEAN

Oblike robov Drugi robovi po povpraševanju		Board 
Debelina (mm)		15
Dimenzije (mm) Druge dimenzije po povpraševanju		600 x 600 625 x 625
Sistemi		Vidni sistem, snemljive plošče - sistem C
Teža		3.6 kg / m ²
Barva		Bela
Absorpcija zvoka		EN ISO 354 $\alpha_w = \mathbf{0.10 (L)}$ skladno z EN ISO 11654 Frekvenca f (Hz) 125 250 500 1000 2000 4000 α_p 0.35 0.20 0.10 0.10 0.10 0.10 NRC = 0.15 skladno z ASTM C 423
Vzdolžna zvočna izolativnost		EN ISO 10848-2 $D_{n,f,w} = \mathbf{34 dB}$ skladno z EN ISO 717-1
Zvočna izolativnost		EN ISO 10140-2 $R_w = \mathbf{19 dB}$ skladno z EN ISO 717-1
Stopnja požarne odpornosti		Euroclass A2-s3, d0 skladno z EN 13501-1
Odboj svetlobe		81%
Toplotna prevodnost		$\lambda = \mathbf{0.060 W/mk}$ skladno z EN 12667
Prepustnost zraka		PM1 ($\leq 30 \text{ m}^3/\text{hm}^2$) skladno z DIN 18177
Odpornost proti vlagi		95% RH
Klasifikacija čistega prostora		ISO 4 skladno z EN ISO 14644-1
Kakovost zraka		 A+  E1
Čiščenje	  	
Trajnost	 	45% EN ISO 14021 EC 1272/2008 Annex G

Razpoložljivost izdelkov se lahko razlikuje od države do države.
Za več informacij se obrnite na lokalnega prodajnega predstavnika.
Dodatne in pravne informacije najdete na naši spletni strani.





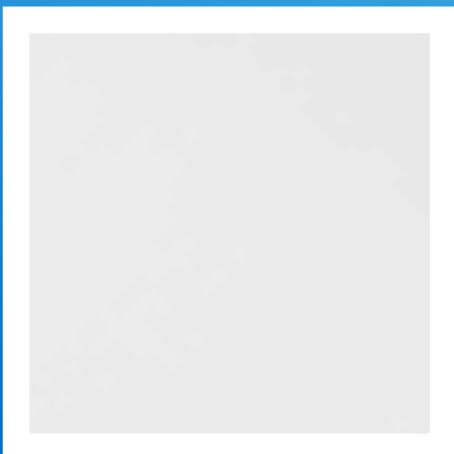







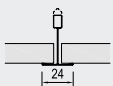
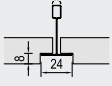
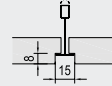











AMF TOPIQ® Prime Hygena



- AMF TOPIQ® Prime Hygena so zelo lahke plošče iz kamene volne z moderno gladko belo površino. Površina se lahko čisti in je antibakterijsko zaščitena (preprečuje razvoj klic, bakterij in gljiv).
- Odlična zvočna absorpcija (0.95 α_w)
- Odlična svetlobna odbojnost (88%)
- ISO 5
- Idealno za zdravstvene ustanove, kuhinje, prehransko industrijo, laboratorije...



AMF TOPIQ® PRIME HYGENA

Oblike robov Drugi robovi po povpraševanju		Board 	Tegular 24/90 	Tegular 15/90 														
Debelina (mm)		15	15	15														
Dimenzije (mm) Druge dimenzije po povpraševanju		600 x 600 625 x 625 1250 x 625	600 x 600 625 x 625	600 x 600 625 x 625														
Sistemi		Vidni sistem, snemljive plošče - sistem C																
Teža		2.1 kg/m ²																
Barva		Bela																
Absorpcija zvoka		EN ISO 354 $\alpha_w = \mathbf{0.95}$ skladno z EN ISO 11654 - Class A <table border="1"> <thead> <tr> <th>Frekvenca f (Hz)</th> <th>125</th> <th>250</th> <th>500</th> <th>1000</th> <th>2000</th> <th>4000</th> </tr> </thead> <tbody> <tr> <td>α_p</td> <td>0.50</td> <td>0.85</td> <td>0.95</td> <td>0.90</td> <td>1.00</td> <td>1.00</td> </tr> </tbody> </table> NRC = 0.90 skladno z ASTM C 423			Frekvenca f (Hz)	125	250	500	1000	2000	4000	α_p	0.50	0.85	0.95	0.90	1.00	1.00
Frekvenca f (Hz)	125	250	500	1000	2000	4000												
α_p	0.50	0.85	0.95	0.90	1.00	1.00												
Vzdolžna zvočna izolativnost		EN ISO 10848-2 $D_{n,f,w} = \mathbf{24 dB}$ skladno z EN ISO 717-1																
Zvočna izolativnost		EN ISO 10140-2 $R_w = \mathbf{13 dB}$ skladno z EN ISO 717-1																
Stopnja požarne odpornosti		Euroclass A1 skladno z EN 13501-1	RUS KM2 (G1, V2, D1, T1) skladno z 123-FZ															
Odboj svetlobe		88%																
Odpornost proti vlagi		100% RH																
Klasifikacija čistega prostora		ISO 5 skladno z EN ISO 14644-1																
Kakovost zraka		 A	 E1															
Čiščenje																		
Trajnost	 EN ISO 14021	 BIOSOLUBLE WOOL EC 1272/2008 Annex Q 33%																

Razpoložljivost izdelkov se lahko razlikuje od države do države.
 Za več informacij se obrnite na lokalnega prodajnega predstavnika.
 Dodatne in pravne informacije najdete na naši spletni strani.







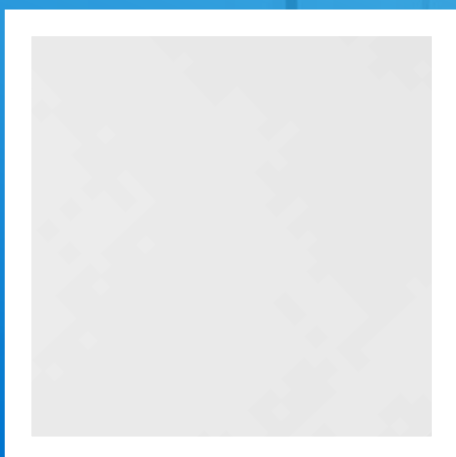



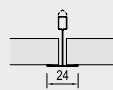
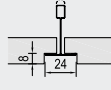
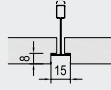













AMF TOPIQ® Efficient Pro Hygena

- AMF TOPIQ® Efficient pro Hygena so zelo lahke plošče iz kamene volne z moderno gladko površino. Površina se lahko čisti in je antibakterijsko zaščitena (preprečuje rast klic, bakterij in gljiv).
- Odlična zvočna absorpcija (1.00 α_w)
- Odlična svetlobna odbojnost (88%)
- ISO 4
- Zelo primerno za zdravstvene ustanove, kuhinje, prehransko industrijo, laboratorije...



AMF TOPIQ® EFFICIENT PRO HYGENA

Oblike robov Drugi robovi po povpraševanju		Board 	Tegular 24/90 	Tegular 15/90 														
Debelina (mm)		20	20	20														
Dimenzije (mm) Druge dimenzije po povpraševanju		600 x 600 1200 x 600	600 x 600 625 x 625	600 x 600 625 x 625														
Sistemi		Vidni sistem, snemljive plošče - sistem C																
Teža		2.8 kg / m ²																
Barva		Bela																
Absorpcija zvoka		EN ISO 354 $\alpha_w = 1.00$ skladno z EN ISO 11654 - Class A <table border="1"> <thead> <tr> <th>Frekvenca f (Hz)</th> <th>125</th> <th>250</th> <th>500</th> <th>1000</th> <th>2000</th> <th>4000</th> </tr> </thead> <tbody> <tr> <td>α_p</td> <td>0.45</td> <td>0.90</td> <td>1.00</td> <td>0.95</td> <td>1.00</td> <td>1.00</td> </tr> </tbody> </table> NRC = 0.95 skladno z ASTM C 423			Frekvenca f (Hz)	125	250	500	1000	2000	4000	α_p	0.45	0.90	1.00	0.95	1.00	1.00
Frekvenca f (Hz)	125	250	500	1000	2000	4000												
α_p	0.45	0.90	1.00	0.95	1.00	1.00												
Vzdolžna zvočna izolativnost		EN ISO 10848-2 $D_{n,f,w} = 25 \text{ dB}$ skladno z EN ISO 717-1																
Zvočna izolativnost		EN ISO 10140-2 $R_w = 15 \text{ dB}$ skladno z EN ISO 717-1																
Stopnja požarne odpornosti		Euroclass A1 skladno z EN 13501-1	RUS KM2 (G1, V2, D1, T1) skladno z 123-FZ															
Odboj svetlobe		88%																
Odpornost proti vlagi		100% RH																
Klasifikacija čistega prostora		ISO 4 skladno z EN ISO 14644-1																
Kakovost zraka		 A	 E1															
Čiščenje																		
Trajnost	 EN ISO 14021 33%	 BIOSOLUBLE WOOL EC 1272/2008 Annex G																

Razpoložljivost izdelkov se lahko razlikuje od države do države.
Za več informacij se obrnite na lokalnega prodajnega predstavnika.
Dodatne in pravne informacije najdete na naši spletni strani.





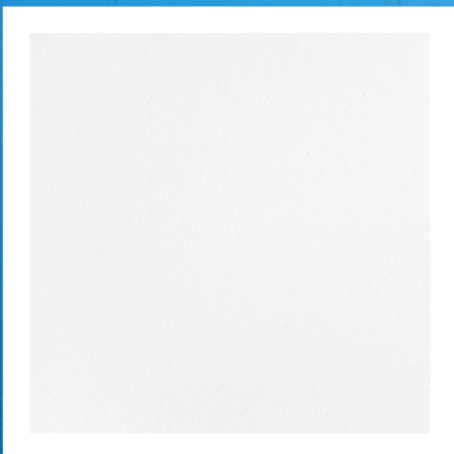







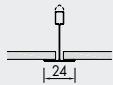





NEWTONE



- Plošče NEWTONE so izdelane iz hidriranega kalcijevega silikata in so odporne na 100 % zračno vlažnost. Primerne so za prostore, kjer sta prisotna ekstremna vlažnost in visoke temperature.
- Visoka vzdolžna zvočna izolativnost (37 dB)
- Zelo primerno za wellnesse ter vodne parke.



NEWTONE

Oblike robov Drugi robovi po povpraševanju	 Board 														
Debelina (mm)	 6														
Dimenzije (mm) Druge dimenzije po povpraševanju	 600 x 600														
Sistemi	 Vidni sistem, snemljive plošče - sistem C														
Teža	 8.0 kg / m ²														
Barva	 Bela														
Absorpcija zvoka	 EN ISO 354 $\alpha_w = 0.10(L)$ skladno z EN ISO 11654 - Class N/A <table border="1" data-bbox="459 860 1453 936"> <thead> <tr> <th>Frekvenca f (Hz)</th> <th>125</th> <th>250</th> <th>500</th> <th>1000</th> <th>2000</th> <th>4000</th> </tr> </thead> <tbody> <tr> <td>α_p</td> <td>0.25</td> <td>0.15</td> <td>0.10</td> <td>0.10</td> <td>0.10</td> <td>0.05</td> </tr> </tbody> </table> NRC = 0.10 skladno z ASTM C 423	Frekvenca f (Hz)	125	250	500	1000	2000	4000	α_p	0.25	0.15	0.10	0.10	0.10	0.05
Frekvenca f (Hz)	125	250	500	1000	2000	4000									
α_p	0.25	0.15	0.10	0.10	0.10	0.05									
Vzdolžna zvočna izolativnost	 EN ISO 10848-2 $D_{n,f,w} = 37 \text{ dB}$ skladno z EN ISO 717-1														
Stopnja požarne odpornosti	 Euroclass A1 skladno z EN 13501-1 RUS KMO (NG) skladno z 123-FZ														
Odboj svetlobe	 84%														
Odpornost proti vlagi	 100% RH														
Kakovost zraka	  A+ E1														
Čiščenje	   														

V prostorih, kjer se pričakuje, da bo relativna zračna vlažnost redno nad 90 %, priporočamo antikorozijsko podkonstrukcijo Prelude 24 ter drobni material.

Klasično gladko



PORTFELJ NAŠIH KLASIČNIH BELIH MINERALNIH STROPNIH PLOŠČ ZAGOTAVLJA VEČJO RAZPRŠITEV DNEVNE SVETLOBE IN VISOKO RAVEN ZVOČNE IZOLATIVNOSTI ZA ODLIČNO ZASEBNOST MED POSAMEZNIMI PROSTORI.



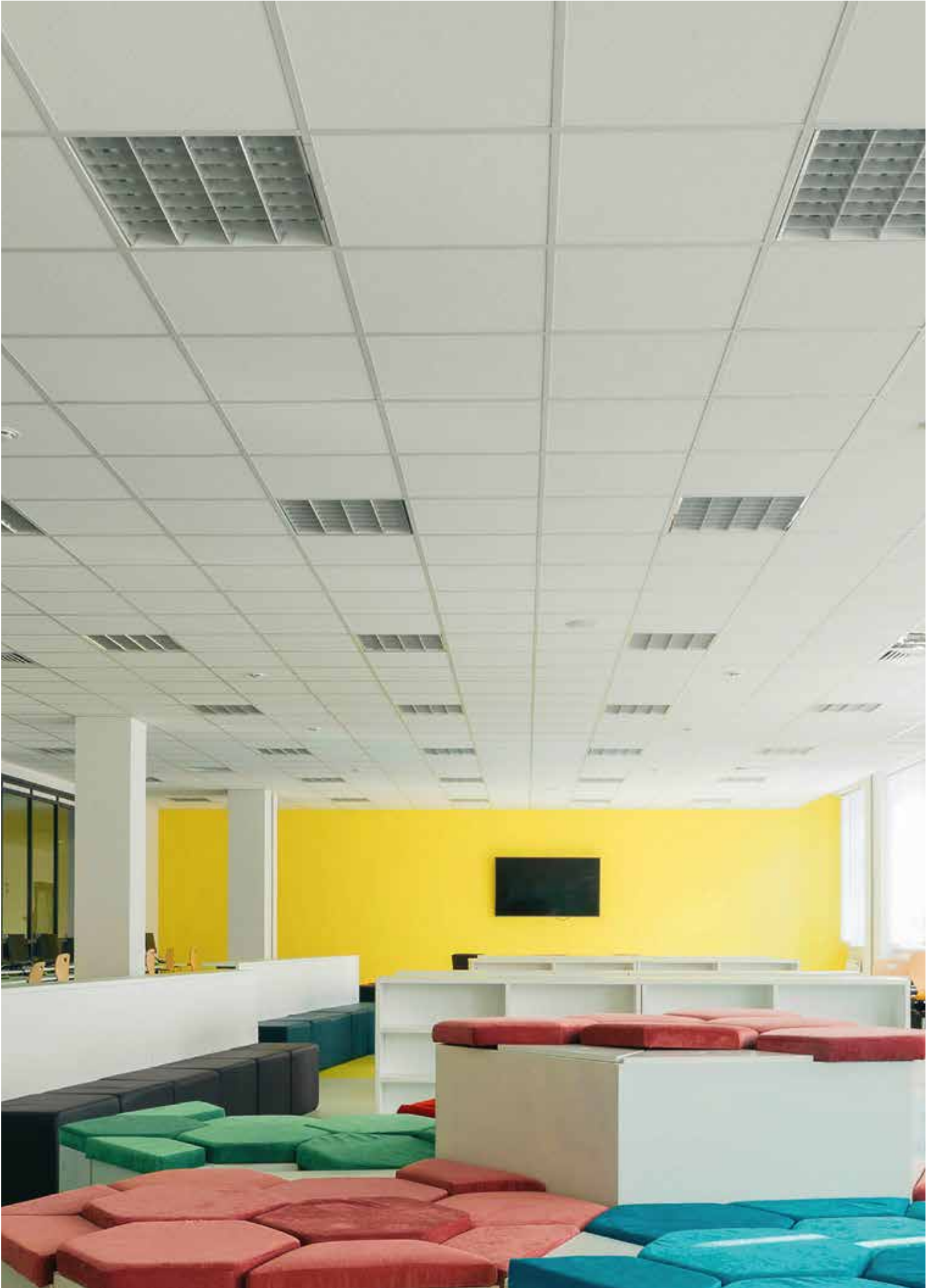



PLAIN

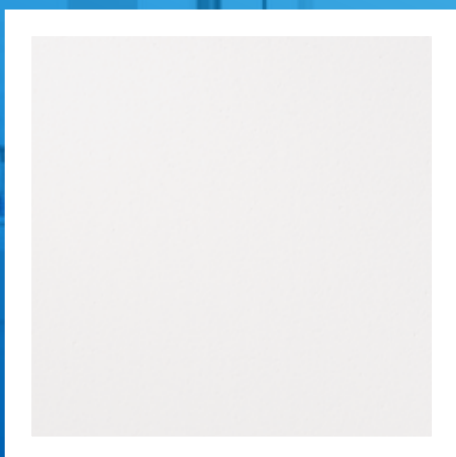

- Plošče PLAIN imajo gladko belo površino, da zadostijo modernim trendom po čistih površinah in po maksimalni svetlobni odbojnosti.
- Dobra vzdolžna zvočna izolativnost (34 dB)
- Odlična svetlobna odbojnost (88 %)
- Primerno za trgovine



PLAIN

Oblike robov Drugi robovi po povpraševanju		Board 	Tegular 24 	Tegular 15 														
Debelina (mm)		15	15	15														
Dimenzije (mm) Druge dimenzije po povpraševanju		600 x 600 1200 x 600	600 x 600 1200 x 600	600 x 600 1200 x 600														
Sistemi		Vidni sistem, snemljive plošče - sistem C																
Teža		3.6 - 3.8 kg / m ²																
Barva		Bela																
Absorpcija zvoka		EN ISO 354 $\alpha_w = \mathbf{0.20(L)}$ skladno z EN ISO 11654 - Class E <table border="1"> <thead> <tr> <th>Frekvenca f (Hz)</th> <th>125</th> <th>250</th> <th>500</th> <th>1000</th> <th>2000</th> <th>4000</th> </tr> </thead> <tbody> <tr> <td>α_p</td> <td>0.30</td> <td>0.25</td> <td>0.15</td> <td>0.15</td> <td>0.25</td> <td>0.30</td> </tr> </tbody> </table> NRC = 0.20 skladno z ASTM C 423			Frekvenca f (Hz)	125	250	500	1000	2000	4000	α_p	0.30	0.25	0.15	0.15	0.25	0.30
Frekvenca f (Hz)	125	250	500	1000	2000	4000												
α_p	0.30	0.25	0.15	0.15	0.25	0.30												
Vzdolžna zvočna izolativnost		EN ISO 10848-2 $D_{n,f,w} = \mathbf{34 dB}$ skladno z EN ISO 717-1																
Stopnja požarne odpornosti		Euroclass A2-s1, d0 skladno z EN 13501-1	RUS KM1 (G1, V1, D1, T1) skladno z 123-FZ															
Odboj svetlobe		88%																
Toplotna prevodnost		$\lambda = \mathbf{0.060 W/mK}$ skladno z EN 12667																
Odpornost proti vlagi		95% RH																
Klasifikacija čistega prostora		ISO 4 skladno z EN ISO 14644-1																
Kakovost zraka		 A+	 E1	 IACG														
Čiščenje																		
Trajnost	 EN ISO 14021	 EN ISO 14025	 EC 1272/2008 Annex G	31 - 48%														

Razpoložljivost izdelkov se lahko razlikuje od države do države.
 Za več informacij se obrnite na lokalnega prodajnega predstavnika.
 Dodatne in pravne informacije najdete na naši spletni strani.



Klasično Strukturirano

KLASIČNE MINERALNE STROPNE PLOŠČE ZA SPUŠČENE STROPE Z RAHLO STRUKTURIRANO POVRŠINO SKRBIJO ZA IDEALNO RAVNOVESJE MED ODBOJEM SVETLOBE IN AKUSTIČNO UČINKOVITOSTJO ZA OPTIMIZACIJO UDOBJA V PROSTORU.















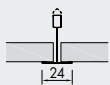
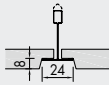
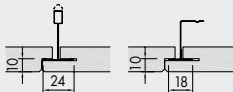







ARMSTRONG SAHARA



- Plošče Armstrong SAHARA imajo rahlo strukturirano in mikroperforirano površino, ki združuje dobro zvočno absorpcijo ter vzdolžno zvočno izolativnost.
- Dobra zvočna absorpcija ($0,60 \alpha_w$) in vzdolžna zvočna izolativnost (34 dB)
- Dobra svetlobna odbojnost (85 %)
- Primerno za pisarne ter izobraževalne prostore



ARMSTRONG SAHARA

Oblike robov Drugi robovi po povpraševanju		Board 	Tegular 24 	Tegular 15 	SL2 																					
Debelina (mm)		15	15	15	19																					
Dimenzije (mm) Druge dimenzije po povpraševanju		600 x 600 675 x 675 1200 x 600 1500 x 300 1800 x 300	600 x 600 675 x 675 1200 x 600	600 x 600 675 x 675 1200 x 600 1200 x 300	1500 x 300 1800 x 300 2500 x 300																					
Sistemi		Vidni sistem, snemljive plošče - sistem C Konstrukcija z vzporednim bandrastrom, vidni ali skriti prečni profil - sistem I.3 Prosto vpeti sistemi, vidni ali zakriti nosilni profili - sistem F.3			Lamelne snemljive plošče - sistem I.3 Konstrukcija z vzporednim bandrastrom, lamelne snemljive plošče - sistem I.2 Prosto vpeti sistem z zakritimi nosilnimi profili, snemljive plošče - sistem F.2																					
Teža		3.7 - 5.0 kg / m ² (15 - 19mm)																								
Barva		Bela																								
Absorpcija zvoka		<p>EN ISO 354</p> <p>$\alpha_w = \mathbf{0.60}$ skladno z EN ISO 11654 - Class C</p> <table border="1"> <thead> <tr> <th>Frekvenca f (Hz)</th> <th>125</th> <th>250</th> <th>500</th> <th>1000</th> <th>2000</th> <th>4000</th> </tr> </thead> <tbody> <tr> <td>α_p Board, Tegular</td> <td>0.45</td> <td>0.40</td> <td>0.55</td> <td>0.65</td> <td>0.65</td> <td>0.60</td> </tr> <tr> <td>SL2</td> <td>0.35</td> <td>0.45</td> <td>0.60</td> <td>0.65</td> <td>0.55</td> <td>0.45</td> </tr> </tbody> </table> <p>NRC = 0.55 skladno z ASTM C 423</p>				Frekvenca f (Hz)	125	250	500	1000	2000	4000	α_p Board, Tegular	0.45	0.40	0.55	0.65	0.65	0.60	SL2	0.35	0.45	0.60	0.65	0.55	0.45
Frekvenca f (Hz)	125	250	500	1000	2000	4000																				
α_p Board, Tegular	0.45	0.40	0.55	0.65	0.65	0.60																				
SL2	0.35	0.45	0.60	0.65	0.55	0.45																				
Vzdolžna zvočna izolativnost		EN ISO 10848-2 $D_{n,f,w} = \mathbf{34 dB}$ (15mm) skladno z EN ISO 717-1		$D_{n,f,w} = \mathbf{38 dB}$ (19mm) skladno z EN ISO 717-1																						
Zvočna izolativnost		EN ISO 10140-2 $R_w = \mathbf{17 dB}$ (15mm) skladno z EN ISO 717-1		$R_w = \mathbf{21 dB}$ (19mm) skladno z EN ISO 717-1																						
Stopnja požarne odpornosti		Euroclass A2-s1, d0 skladno z EN 13501-1		RUS KM1 (G1, V1, D1, T1) skladno z 123-FZ																						
Odboj svetlobe		85%																								
Toplotna prevodnost		$\lambda = \mathbf{0.060 W/mk}$ skladno z EN 12667																								
Odpornost proti vlagi		95% RH																								
Kakovost zraka		 A+	 E1	 IACG																						
Čiščenje																										
Trajnost																										
		37 - 43%																								

Razpoložljivost izdelkov se lahko razlikuje od države do države.
Za več informacij se obrnite na lokalnega prodajnega predstavnika.
Dodatne in pravne informacije najdete na naši spletni strani.





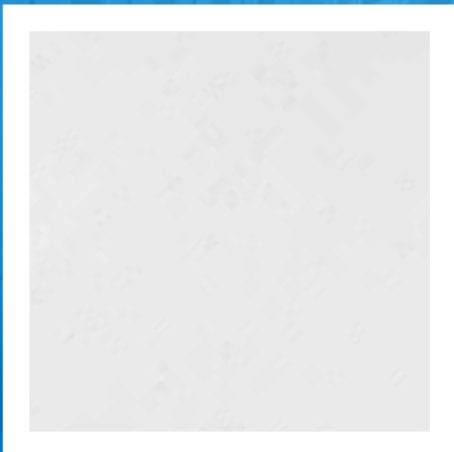







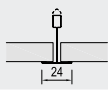
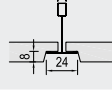
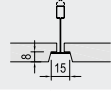
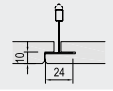
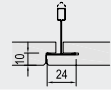
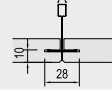











AMF THERMATEX® Feinstratos



- Plošče AMF THERMATEX® Feinstratos ustvarjajo enakomerno površino zaradi fine površinske strukture.
- Dobra vzdolžna izolativnost (34 dB)
- Dobra svetlobna odbojnost (85 %)
- Primerno za trgovine, sejne sobe, tehnične in proizvodne prostore.



AMF THERMATEX® FEINSTRATOS

Oblike robov Drugi robovi po povpraševanju		Board 	Tegular 24 	Tegular 15 	Finesse 	SL2 	K2C2 				
Debelina (mm)		15	15	15	19	19	15				
Dimenzije (mm) Druge dimenzije po povpraševanju		600 x 600 625 x 625 1200 x 600 1250 x 625 1800 x 300 2500 x 300	600 x 600 625 x 625 1200 x 600	600 x 600 625 x 625 1200 x 600	600 x 600	2000 x 312,5 2500 x 312,5	2000 x 312,5 2500 x 312,5				
Sistemi		Vidni sistem, snemljive plošče - sistem C Konstrukcija z vzporednim bandrastrom, vidni ali skriti prečni profil - sistem I.3 Prosto vpeti sistemi, vidni ali zakriti nosilni profili - sistem F.3			Zakriti sistem, snemljive plošče - sistem A2	Lamelne snemljive plošče - sistem I.3 Konstrukcija z vzporednim bandrastrom, lamelne snemljive plošče - sistem I.2 Prosto vpeti sistem z zakritimi nosilnimi profili, snemljive plošče - sistem F.2	Lamelne nesnemljive plošče - sistem I.3 Konstrukcija z vzporednim bandrastrom, lamelne nesnemljive plošče - sistem I.1 Prosto vpeti sistem z zakritimi nosilnimi profili, nesnemljive plošče - sistem F.1				
Teža		3.8 - 5.0 kg / m ²									
Barva		Bela									
Absorpcija zvoka		EN ISO 354 $\alpha_w = 0.20$ skladno z EN ISO 11654 - Class E Frekvenca f (Hz)									
					125	250	500	1000	2000	4000	
					α_p	0.35	0.20	0.15	0.15	0.20	0.20
		NRC = 0.15 skladno z ASTM C 423									
Vzdolžna zvočna izolativnost		EN ISO 10848-2 $D_{n,f,w} = 34$ dB (Board, Tegular 24, Tegular 15, K2C2) skladno z EN ISO 717-1 $D_{n,f,w} = 38$ dB (Finesse, SL2) skladno z EN ISO 717-1									
Zvočna izolativnost		EN ISO 10140-2 $R_w = 21$ dB skladno z EN ISO 717-1									
Stopnja požarne odpornosti		Euroclass A2-s1, d0 skladno z EN 13501-1			RUS KM1 (G1, V1, D1, T1) skladno z 123-FZ						
Odboj svetlobe		85%									
Toplotna prevodnost		$\lambda = 0.060$ W/mk skladno z EN 12667									
Odpornost proti vlagi		95% RH									
Kakovost zraka		 A+	 E1	 IACG							
Čiščenje											
Trajnost											
		EN ISO 14021	EN ISO 14025	EC 1272/2008 Annex Q	37-43%						

Razpoložljivost izdelkov se lahko razlikuje od države do države.
Za več informacij se obrnite na lokalnega prodajnega predstavnika.
Dodatne in pravne informacije najdete na naši spletni strani.

Klasično Perforirano

IZBERITE KLASIČNE MINERALNE STROPNE PLOŠČE S PERFORIRANO POVRŠINO IN UŽIVAJTE V EDINSTVENI KOMBINACIJI VRHUNSKE ABSORPCIJE ZVOKA IN ZVOČNE IZOLATIVNOSTI ZA IZBOLJŠANO RAZUMLJIVOST GOVORA.

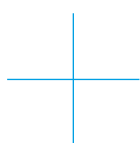

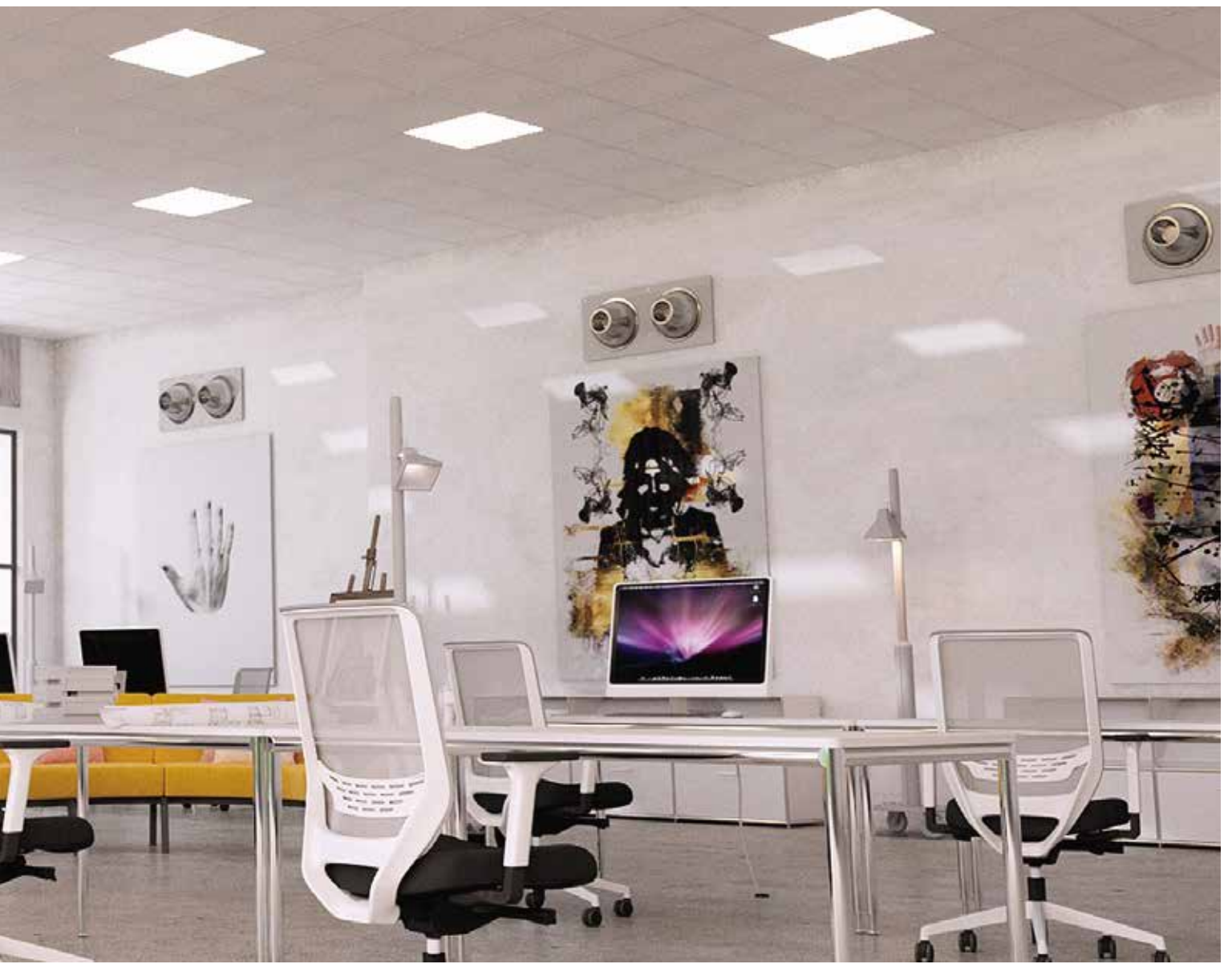



TEHNIČNI LIST











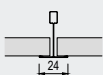
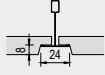
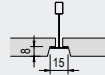













Star 15mm



- Plošče Star 15mm zaznamuje fina neenakomerna perforacija z gladko površino in navdušuje z moderno vizualno obliko.
- Dobra zvočna absorpcija ($0.60 \alpha_w$)
- Dobra vzdolžna zvočna izolativnost (34 dB)
- Odlična svetlobna odbojnost (88 %)
- Primerno za trgovine, pisarne, proizvodne prostore

TEHNIČNI LIST

Star 15mm

Oblike robov		Board	Tegular 24	Tegular 15	K2C2			
Drugi robovi po povpraševanju								
Debelina (mm)		15	15	15	15			
Dimenzije (mm)		600 x 600 625 x 625 1200 x 600 1250 x 625 2500 x 300	600 x 600 625 x 625 1200 x 600	600 x 600 625 x 625 1200 x 600	2000 x 312,5 2500 x 312,5			
Sistemi		Vidni sistem, snemljive plošče - sistem C Konstrukcija iz vzporednim bandrastom, vidni ali skriti prečni profil - sistem I.3 Prosto vpeti sistemi, vidni ali zakriti nosilni profili - sistem F.3			Lamelne nesnemljive plošče - sistem I.3			
Teža		3.6 - 3.8 kg / m ²						
Barva		 White						
Absorpcija zvoka		EN ISO 354 $\alpha_w = 0.60$ skladno z EN ISO 11654 - Class C						
		Frequency f (Hz)	125	250	500	1000	2000	4000
		α_p	0.45	0.50	0.55	0.70	0.65	0.50
		NRC = 0.60 skladno z ASTM C 423						
Vzdolžna zvočna izolativnost		EN ISO 10848-2 CAC = 35 dB skladno z ASTM E 413-10						
		$D_{n,f,w} = 34 \text{ dB}$ skladno z EN ISO 717-1						
Zvočna izolativnost		EN ISO 10140-2 CAC = 35 dB skladno z ASTM E 413-10						
		$R_w = 21 \text{ dB}$ skladno z EN ISO 717-1						
Stopnja požarne odpornosti		Euroclass A2-s1, d0 skladno z EN 13501-1 Class A skladno z ASTM E 84						
Odboj svetlobe		88%						
Toplotna prevodnost		$\lambda = 0.060 \text{ W/mk}$ skladno z EN 12667						
Odpornost proti vlagi		95% RH						
Kakovost zraka		 A+	 E1					
Čiščenje								
Trajnost	 EN ISO 14021 37-48%	 EN ISO 14025	 EC 1272/2008 Annex Q					

Razpoložljivost izdelkov se lahko razlikuje od države do države.
Za več informacij se obrnite na lokalnega prodajnega predstavnika.
Dodatne in pravne informacije najdete na naši spletni strani.



AMF THERMATEX® Feinfresko



- Plošče AMF THERMATEX® Feinfresko imajo neenakomerno perforirano površino in nudijo dobro zvočno absorpcijo za boljše akustično udobje v prostoru.
- Dobra zvočna absorpcija (0.60(H) α_w)
- Visoka vzdolžna zvočna izolativnost (32 dB)
- Primerno za trgovine, pisarne, sejne sobe, tehnične in proizvodne prostore.

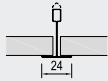

AMF THERMATEX® FEINFRESKO

Oblike robov Drugi robovi po povpraševanju		Board 	Tegular 24 														
Debelina (mm)		15	15														
Dimenzije (mm) Druge dimenzije po povpraševanju		600 x 600 625 x 625 1200 x 600 1250 x 625	600 x 600 625 x 625														
Sistemi		Vidni sistem, snemljive plošče - sistem C															
Teža		3.6 - 3.8 kg / m ²															
Barva		Bela															
Absorpcija zvoka		EN ISO 354 $\alpha_w = \mathbf{0.60 (H)}$ skladno z EN ISO 11654 - Class C <table border="1"> <thead> <tr> <th>Frekvenca f (Hz)</th> <th>125</th> <th>250</th> <th>500</th> <th>1000</th> <th>2000</th> <th>4000</th> </tr> </thead> <tbody> <tr> <td>α_p</td> <td>0.45</td> <td>0.40</td> <td>0.50</td> <td>0.70</td> <td>0.80</td> <td>0.75</td> </tr> </tbody> </table> NRC = 0.60 skladno z ASTM C 423		Frekvenca f (Hz)	125	250	500	1000	2000	4000	α_p	0.45	0.40	0.50	0.70	0.80	0.75
Frekvenca f (Hz)	125	250	500	1000	2000	4000											
α_p	0.45	0.40	0.50	0.70	0.80	0.75											
Vzdolžna zvočna izolativnost		EN ISO 10848-2 $D_{n,f,w} = \mathbf{32 dB}$ skladno z EN ISO 717-1															
Zvočna izolativnost		EN ISO 10140-2 $R_w = \mathbf{21 dB}$ skladno z EN ISO 717-1															
Stopnja požarne odpornosti		Euroclass A2-s1, d0 skladno z EN 13501-1	RUS KM1 (G1, V1, D1, T1) skladno z 123-FZ														
Odboj svetlobe		83%															
Toplotna prevodnost		$\lambda = \mathbf{0.060 W/mk}$ skladno z EN 12667															
Prepustnost zraka		PM1 ($\leq 30 \text{ m}^3/\text{hm}^2$) skladno z DIN 18177															
Odpornost proti vlagi		90% RH															
Kakovost zraka		 A+	 E1														
		 IACG															
Čiščenje																	
Trajnost																	
		37-48%															

Razpoložljivost izdelkov se lahko razlikuje od države do države.
 Za več informacij se obrnite na lokalnega prodajnega predstavnika.
 Dodatne in pravne informacije najdete na naši spletni strani.





Požarna Zaščita

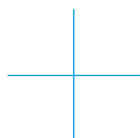

POŽARNA ODPORNOST JE POMEMBNA
LASTNOST VSAKEGA STROPNEGA SISTEMA
– NE GLEDE NA TO, KAKO PREPROSTI ALI
ZAPLETENI SO.

Naše stropne plošče so zasnovane tako, da ustrezajo najstrožjim industrijskim standardom. Izberite med široko paleto videzov in akustičnih možnosti, da izpolnite svoje zahteve glede dizajna in odziva na ogenj.

IZKUSITE VEČ MOŽNOSTI



AMF THERMATEx® Uno

Uno EI 30

Sistem Uno je rešitev za spuščene stropove, ki se raztezajo čez hodnike, ki ponuja neodvisno protipožarno zaščito EI 30 s spodnje in zgornje strani. Če pride do požara v votlem medprostoru, dim, plameni in vročina ne morejo priti do spodaj ležečih evakuacijskih poti. Če do požara pride pod stropom, so stavbna konstrukcija in napeljave v stropnem medprostoru zaščitene. Plošče sistema Uno, nameščene na stenske konzole, lahko brez obešal premostijo hodnike širine 2,8 m ter omogočajo hitro in preprosto montažo.

Sistem ponuja dobro raven absorpcije zvoka in je na voljo v različnih izvedbah površine.



STROPNE PODKONSTRUKCIJE ARMSTRONG

»KO SE ZDRUŽITA NATANČNOST IN UČINKOVITOST«



Stropne podkonstrukcije Knauf Ceiling Solutions vključujejo celotno paleto rešitev in podrobnosti za vse zahteve spuščениh stropov. Na voljo je tudi širok portfelj dodatne opreme.

OSNOVNE REŠITVE

Nabor standardnih vidnih stropnih podkonstrukcij, vključno s Prelude 15, Prelude 24, Prelude 24 Sixty² za daljše razpone, Prelude 35 in Bandraster.

- **PEAKFORM** 

Večina profilov v portfelju Prelude ima inovativno obliko Peakform, ki je višja in je zasnovana za močnejše in trdnejše stropne podkonstrukcije. Oblika Peakform omogoča hitrejše in lažje rezanje glavnih in prečnih profilov.

- **GLAVNI PROFIL PRELUDE UNIVERSAL**

Glavni profil Prelude Universal je univerzalno uporaben in podpira tako namestitve prečnih profilov TL² ali TL v s kavlji ali prečnih profilov XL² v s povezavo na klik.

- **PREČNI PROFIL XL² - klik spajanje**

Prečniki Prelude XL² so opremljeni z naprednim vtičnim sistemom, ki se zapre s slišnim klikom in ves čas zagotavlja trdno namestitev.

- **PREČNI PROFILI TL² – namestitev s kavlji**

TL² je visokotehnološka rešitev z natičnimi kavlji s patentirano spojko.

- **PREČNI PROFILI TL – namestitev s kavlji**

Prečni profili Prelude TL s širino 15 mm imajo nameščen napreden integriran kavelj.

Izdelki se lahko razlikujejo od države do države.
V primeru vprašanj kontaktirajte lokalnega predstavnika.

OBLIKOVNE REŠITVE



PERFECTLINE XL² je zasnovan tako, da ustvari svež, čist videz za izboljšano estetiko. Profil je poravnan s stropno površino, tako da je vidna le fuga 3 do 6 mm.

POSEBNE REŠITVE



- **Clean Room 24** so edinstveni profili iz aluminija s tesnilom iz PVC-ja, ki ustvarja tesnejši stik med ploščami in profili za uporabo v čistih in »nemagnetnih« okoljih.
- **Prelude 24 Corrosive Resistant** ima poseben premaz in je namenjen za prostore, ki zahtevajo večjo odpornost proti koroziji.
- **System Z** je sistem, ki lamelnim ploščam SL2 zagotavlja dostopnost in delno zakrit videz.
- **Seismic Rx[®]** je poseben protipotresni način namestitve podkonstrukcije Prelude 24 s prečniki XL², ki je kombiniran s posebno dodatno opremo.

REŠITVE ZA HODNIKE



- Širok izbor možnosti za hodnike, ki ponujajo polzakrito podkonstrukcijo za hodnike s snemljivimi lamelami SL2.

AXIOM PROFILI



- Prehodi, profili in dodatki AXIOM dopolnjujejo tradicionalno paleto obodnih profilov. Spreminjajte nivo stropov, dodajte obodne osvetlitve ali izdelajte prehod med rastrskim in mavčnim stropom.



Preizkušena tehnologija DONN® DX s patentirano zlato sponko že dolgo velja za zagotovilo visokokakovostne stropne podkonstrukcije. Široka paleta izdelkov zagotavlja dosledno, prilagodljivo in certificirano kompatibilnost sistema.

PREDNOSTI IZDELKA

- Večja stabilnost, varnost, hitrejša namestitvev.
- Zasnova s tremi rebri za večjo trdnost.
- Jasna slišna »klik« povezava.
- Združljiv z vsemi priloženimi akustičnimi stropnimi ploščami.
- Individualen dizajn stropa z izbiro barvne možnosti za vidno stran profila: črna mat (LM), kovinska 06 (D), aluminijasta (A), kromasta (M), zlata (Q) barva, druge barve RAL so na voljo na zahtevo
- Širok portfelj sistemskih požarnih preizkusov za vse običajne izvedbe osnovnih stropov v skladu z najnovejšim standardom EN 1365-2 v povezavi z EN 1363-1

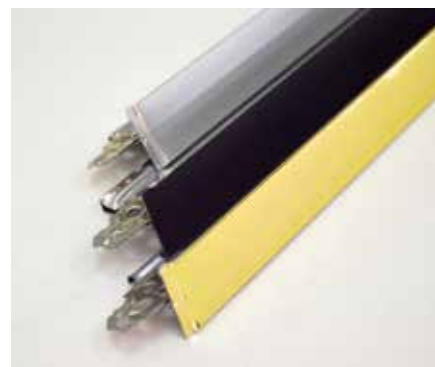

Izdelki se lahko razlikujejo od države do države.
V primeru vprašanj kontaktirajte lokalnega predstavnika.

STABILNA IN VARNA PODKONSTRUKCIJA

Tehnologija DX3® s svojo patentirano rebrasto obliko daje glavnim profilom DX in dolgim prečnim profilom še večjo togost. Profili so oblikovno stabilnejši in imajo večjo torzijsko trdnost. To omogoča lažjo in hitrejšo montažo ter stabilno in varno podkonstrukcijo.

PORTFELJ PREIZKUŠENIH SISTEMOV DONN®

Standard DX

Za vse standardne sisteme DX je značilna kombinacija nevsiljivega videza in visoke ekonomičnosti. Sistemi so na voljo s širino profila 24 in 15 mm (vidna površina).

Oblikovanje in estetika

Značilnost te kategorije sistemov so zavestno ustvarjene senčne fuge za uprizoritev modularnosti kot pri sistemu DX Finline. Sistemi imajo v vidni površini profila utor (širine 6,5 mm) v obliki votlega prostora, ki v odvisnosti od svetlobnih razmer v prostoru ustvari bolj ali manj dominantno delujočo senčno fugo.

Funkcionalnost in dizajn

Vse večje število stropnih konstrukcij zahteva posebne rešitve, ki jih ni mogoče doseči z običajnimi sistemi. Med njimi so med drugim sistemi za široke razpone, sistemi za velike obremenitve, sistemi za hodnike in sistemi s protikorozijsko zaščito.



AMF VENTATEC®

»KAKOVOST IN FLEKSIBILNOST«



Te profile odlikujejo visoka kakovost materiala in natančne izdelave. Visokozmogljiva zasnova izdelka zagotavlja trdnost, varnost in prilagodljivost konstrukcije. V kombinaciji s stropnimi ploščami AMF THERMATEX® nastane najboljše usklajen stopni sistem, ki ustreza najvišjim zahtevam.

PREDNOSTI IZDELKA

- Modularni sistem – klik (GK, SG).
- Visoka trdnost zaradi polaganja s šivanjem in rebrastim vzorcem.
- Trdna povezava med glavnimi in prečnimi profili s spojniki iz nerjavnega jekla.
- Preprosta uporaba in namestitvev.
- Hitro in preprosto odstranjevanje prečnih profilov.
- Slišen zaskok potrjuje varno povezavo komponent na klik.
- Širok portfelj sistemskih požarnih preizkusov za vse običajne izvedbe osnovnih stropov v skladu z najnovejšim standardom EN 1365-2 v povezavi z EN 1363-1.

Izdelki se lahko razlikujejo od države do države.
V primeru vprašanj kontaktirajte lokalnega predstavnika.

Individualna in prilagodljiva podkonstrukcija

Sistem profilov AMF VENTATEC® kot praktična konstrukcija na klik ponuja maksimalno prilagodljivost z visokimi ali nizkimi prečnimi profili v GK in SG izvedbi. Na voljo sta širini profila 24 ali 15 mm. S primernim univerzalnim glavnim profilom je mogoče sistem individualno prilagoditi številnim estetskim in funkcionalnim zahtevam.

Preizkušena protipožarna zaščita

Našim kupcem zagotavljamo podporo s preizkušenimi protipožarnimi sistemi za področje stropa. V preteklih letih uvedeni novo razviti izdelki in sistemi so preizkušeni v skladu z najnovejšimi standardi in preizkusnimi kriteriji z upoštevanjem vseh vidikov konstrukcije stropa (kot je npr. integrirana razsvetljava). Tako je na voljo obsežen portfelj veljavnih požarnih testov s sistemom profilov AMF VENTATEC® v kombinaciji s stropnimi ploščicami AMF THERMATEx® in vsemi pomembnimi izvedbami osnovnih stropov.



Zaradi postopkov reprodukcije barv, prikazane v tem katalogu, se lahko barve razlikujejo od dejanskih barv izdelkov. Izbor izdelkov je treba vedno opraviti iz ponudbe vzorcev Knauf Ceiling Solutions. Vse podrobnosti in tehnične informacije, navedene v tej brošuri ali drugem reklamnem gradivu, ki se nanašajo na stropne sisteme Knauf Ceiling Solutions, temeljijo na poročilih o preizkusih, pridobljenih v laboratorijskih pogojih. Stranka je sama odgovorna, da zagotovi, da so ti podatki primerni za predlagano uporabo. Vse navedene informacije temeljijo na trenutnih tehničnih podatkih. Na voljo so dodatna ustrezna poročila o preizkusih, ocene in navodila za namestitve. Vse podrobnosti sistema so v skladu s trenutnimi standardi ter temeljijo na uporabi izdelkov in komponent sistema Knauf Ceiling Solutions. Knauf Ceiling Solutions ne prevzema nobene odgovornosti za uporabo komponent tretjih oseb ali kakršnih koli sprememb pogojev, določenih v testnih podatkih. Mešanje proizvodnih serij ni priporočljivo. Knauf Ceiling Solutions lahko v skladu s pogoji prodaje spreminja in ureja tehnične podatke brez prehodnega obvestila. Ta katalog nadomesti vse prejšnje različice. V katalogu se lahko pojavijo napake in opustitve ter tiskarske napake.

© Aemelle Deelder, AENA, Anke Müllerlein, Alan Jensen, Alexander Gorchakov, Alexander Orlov, Art Foto M, Baldauf & Baldauf Fotografie, Beat Buhler, Beppe Raso, Bernard Gallandi, Bettina Meckel Fotodesign, River Production, Boris Vezmar, BoysPlayNice, Braca Nadezdic, Clairelize Photography, Claude Fiscaro, Daniel Cheong, Daniel Hager, Dave Parker, David Frutos, David Güntsch, Egor Sachko, Eisma, Erieta Attali, Filip Dujardin, Filip Šlapal, Filippo di Pretoro, Foto Kushtrimi, Foto Lautenschlager, Fotostudio Eder, Francisco Urrutia, Frederic Schweizer, FUD, Grant Smith, Grigori Rassiniere, Gunter Laznia, Bregenz, Hawkins/Brown - Francesco Montaguti, Hisao Suzuki, Horizon Photoworks, IAKW-AG, Andreas Hofer, Ilya Kovalev, Infinite 3D Limited, Insightful Environments, Intermontage, Bjorn Kiezenberg, Ivan Lambrev, Jack Hobhouse, Jakob Joachim, James Sleight Design Quorum, James Stephenson Photography, Jan Willem Schouten, Javier Ortega, Jiří Hloušek, Jiří Pařízek, Joao Morgado, Joel Knight, Johannes Malik, John Sturrock, Jordi Canosa, José Manuel Cutilas, Julia Stakhovskaya, Jurij Kobe, Kalibre, Kamen Valkanov, Katarzyna Ułanska, Kim Oliver, Klemen Razinger, Klomfar + Partner, Külli Salum, Laurent Wangermez, Lindman Photography, Lluís Sans, Luca Girardini, Ludwig Schedl, Marcel Van Hoorn, Matteo Zanardi, McAteer, Mecanoo, Michael van Oosten, Miguel de Guzmán, Miljenko Hegeđić, Miran Kambič, Mitch van Leeuwen, Muller Fotografie, MVL Media Groep, Nail Ziyatdinov, Nike Bourgeois, Nina Baisch, Peter Matthews Photographer, Philip Durrant, Philippe Ruault, Piotr Kępka, Rafael Vargas, Raumundfunktion, Reinhard Ohner, Burghardt ZT GmbH, Rainer Tapper, Renato Izzi, rlc ag, Rob van Esch, Romain Boileux, Rudi Walti, Sandro Lendler, Sebastien Puiatti, Sergei Ananiev, Sergei Kadulin, Sergiy Kadulin Photography, Sergei Kobylko, Simon Garcia, Simon Miles, Siobhan Doran, Sonja Bell, SpheroVision, Studio A&D Architects, StudioVU, Szymon Polański, Tim Soar, Tom Green, U. Beuttemuller, U1, Valerian Wurzer, Vedrana Ergic, Walter Henisch, Wenzel, Wincasa AG, Zara Meller, Žiga Intihar.

YOUR CEILING
OUR SOLUTIONS

Knauf Ceilings Solutions GmbH & Co. KG

Elsenthal 15,
94481 Grafenau, Germany
Phone: +49 8552 422-0
Fax: +49 9323 318-881-856
www.knaufceilingsolutions.com
E-Mail: info.kcs@knauf.com

Registered court: Passau district court,
Registration No.: HRB 1023
VAT No. pursuant to § 27a of the German VAT Act
(Umsatzsteuergesetz): DE131249009
Managing Director:
Karl Wenig