

DONN® DX3-24 GK

Exposed 24 mm grid system - System C

Key features

- DX3 with three rib design for more stability, increased security, faster installation
- Patented golden “Quick-Release™ Clip” for high quality grid system installation
- Clear audible click-connection, and can be removed without tools
- Joggled Cross Tees override the Main Runners; preventing twisting of the Cross Tees

Application areas

- Healthcare / Classrooms / Meeting rooms / Individual offices

Physical data

- Material: galvanised steel
- Surface finish: baked polyester paint
- Colour: all products standard in DONN® White
- Other standard colours available on popular items

DONN® DX3-24

Main Runners (bulb-to-bulb connection)

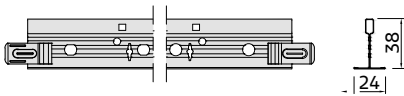

Item reference	Dimensions (mm)			Slot centres	Content/carton		Weight/carton kg	Cartons/pallet
	Length	Width	Height		pcs	lm		
DX3-24TH375W	3700	24	38	156.5	20	75.00	23.00	70
DX3-24TH370W	3700	24	38	100	20	74.00	22.00	70

Available in Matt Black (LM), Metal 06 for an additional charge. Special colours on request.

DONN® DX3-24

Cross Tees (stab system - joggled GK)

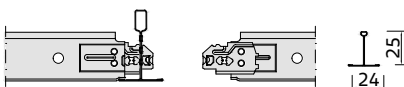
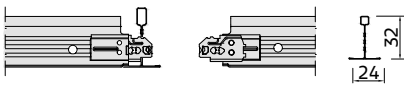
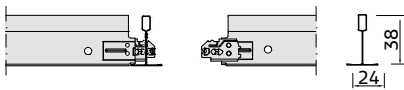

Item reference	Dimensions (mm)			Slot centres	Content/carton		Weight/carton kg	Cartons/pallet
	Length	Width	Height		pcs	lm		
Cross Tees - Slotted								
DX24XH187,5W	1875	24	38	312.5	20	37.5	13.70	70
DX24XH180W	1800	24	38	300	20	36.00	13.50	70
DX3-24TM125W	1250	24	32	312.5	60	75.00	19.90	75
DX3-24TM120W	1200	24	32	300	60	72.00	18.60	75
DX24TS62,5W	625	24	25	312.5	60	37.50	7.70	144
DX24TS60W	600	24	25	300	60	36.00	7.30	144
Cross Tees - Slotted								
DX24TS31,25W	312.5	24	25	-	60	18.75	4.30	100
DX24TS30W	300	24	25	-	60	18.00	4.20	100

Available in Matt Black (LM), Metal 06 for an additional charge. Special colours on request.

Section Drawings

DONN® DX3-24

Main Runners (bulb-to-bulb connection)

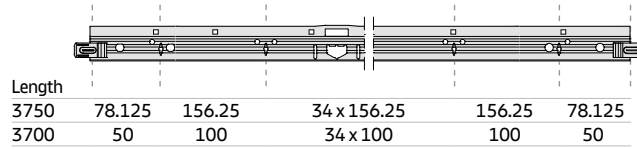

DONN® DX3-24

Cross Tees (stab system - joggled GK)

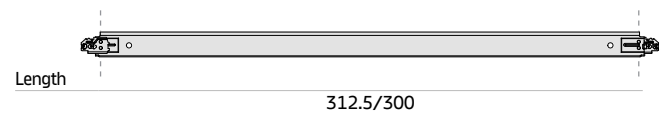
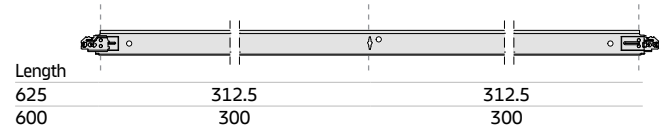
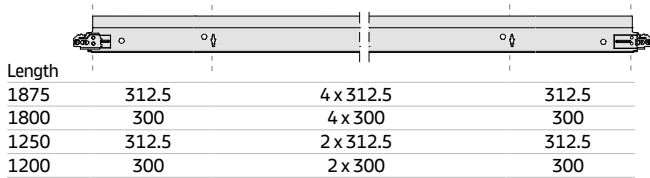

System Drawing - System C

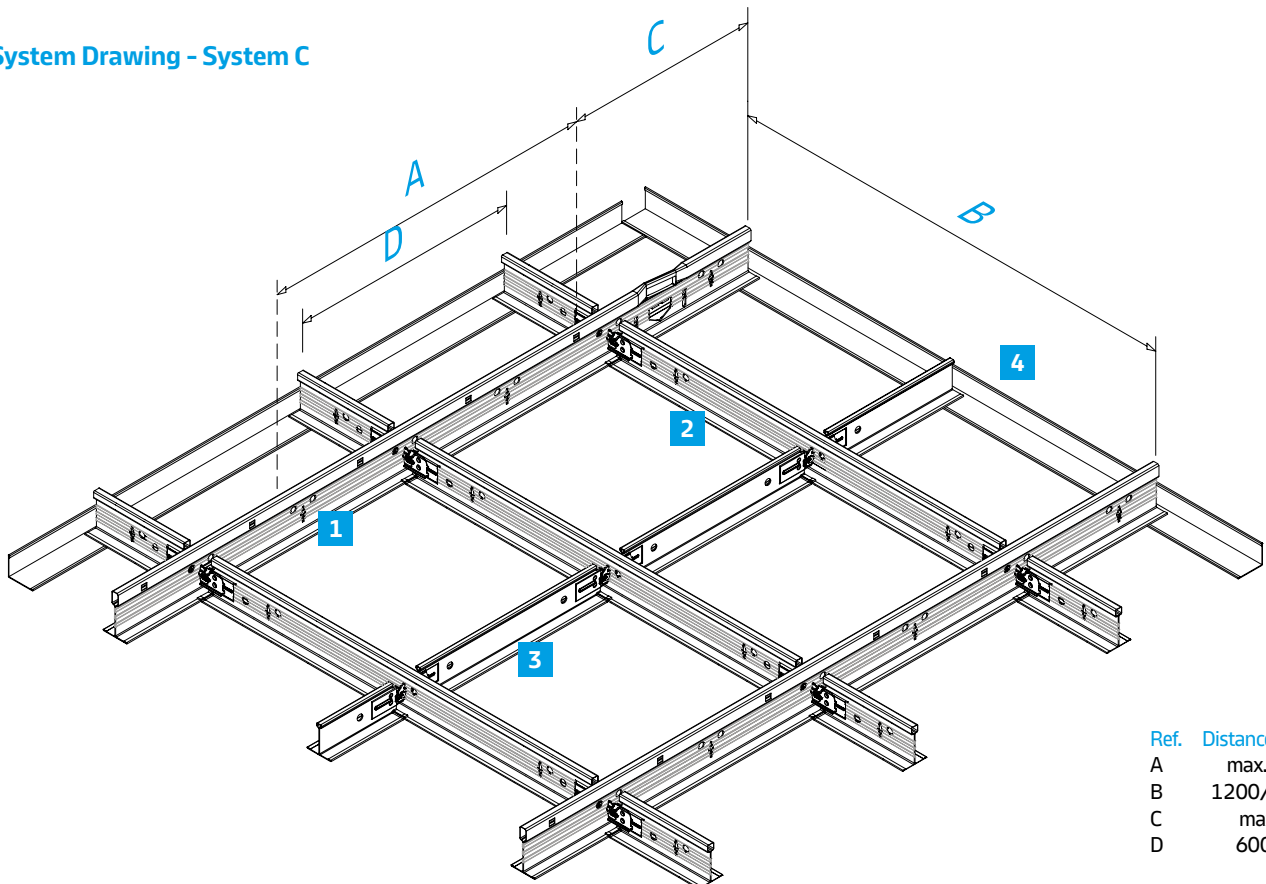

Ref.	Distance (mm)
A	max. 1500
B	1200/1250
C	max. 400
D	600/625

Material required per m² (no waste included)









No.	Description	Item reference	Module 600 x 600	Module 625 x 625	Module 1200 x 600	Module 1250 x 625
1	Main Runner	DX3-24TH370W DX3-24TH375W	0.84 lm -	- 0.80 lm	0.84 lm -	- 0.80 lm
2	Long Cross Tee	DX3-24TM120W DX3-24TM125W	1.67 lm -	- 1.60 lm	1.67 lm -	- 1.60 lm
3	Short Cross Tee	DX24TS60W DX24TS62,5W	0.84 lm	0.84 lm	0.84 lm	
4	Perimeter trim	-	Dependent on room dimensions (approx. 0.6 lm/m ²)			
	Hanger	-	0.70 pcs	0.64 pcs	0.70 pcs	0.64 pcs
	Retaining Clip	-	5.56 pcs	5.56 pcs	5.56 pcs	5.56 pcs
	Tiles	-	2.78 pcs	2.56 pcs	1.39 pcs	1.28 pcs

Load Table

Maximum permissible weight (kg/m²)

Main Runner distances	1800 mm	1875 mm	1200 mm	1250 mm	600 mm	625 mm
Hanger distance A (mm)	Module 600x600	Module 625x625	Module 600x600, 1200x600	Module 625x625, 1250x625	Module 600x600, 1200x600	Module 625x625, 1250x625
800	5.6	4.6	13.9	12.0	25.0	25.0
1000	5.6	4.6	11.6	10.3	25.0	25.0
1200	5.3	4.5	8.4	7.6	18.8	17.7
1500	3.0	-	4.8	4.5	10.2	9.7
Note: The load per m ² must be evenly distributed (no extra point loads). After loading, the deflection will remain within the permitted deflection according to class 1 (L/500) of EN 13964, provided the grid is laid out as shown.						

For other grid layouts, load capacities or hanger distances, please contact Knauf Ceiling Solutions.

Characteristics	Detailed information		
Fire reaction 	Euroclass A2, s1-d0 as per EN 13501-1		
Indoor air quality 		ISO 3	
Cleanability			
Sustainability	 25%	 EPD	 full scope credits to credits 1 star version 2.1

All measurements in millimetres. All sizes are nominal.
Cross Tee alignment is achieved by locating the tees to the left-hand side of the adjoining section.

Products may vary from country to country. Please contact your local sales representative.
For further information and legal notice, please visit our website.