



Sisteme de elemente Baffle verticale

MINERAL Baffle Element

(OPTIMA Baffle)
Singular / Grupat











- Mineral Baffle Element este o gamă de baffle-uri acustice de înaltă performanță, cu o suprafață cașerată albă pentru un aspect liniar modern.
- Absorbție fonică bună (0,50 - 0,65(H) α_w): reduce nivelul de zgomot, crește inteligibilitatea și reduce timpul de reverberație într-un spațiu.
- Utilizate în mod obișnuit pentru a asigura niveluri ridicate de absorbție acustică în birouri, centre de agrement, noduri de transport etc.



MINERAL Baffle Element

Singular / Grupat

Grosime (mm)		39																						
Dimensiuni (mm) Alte dimensiuni, la cerere		1200 x 300 1200 x 400	1800 x 300 1800 x 400																					
Sistem		Set de elemente de suspendare din cablu de oțel Opțiunea de grupare cu profile-U Opțiunea de grupare cu rețea din profile-T																						
Greutate		1200 x 300: 3.8 kg/buc. 1200 x 400: 5.0 kg/buc.	1800 x 300: 5.6 kg/buc. 1800 x 400: 7.5 kg/buc.																					
Culoare & Design																								
Absorbție acustică		EN ISO 354 $\alpha_w = 0.50(MH)$ (300mm) conform EN ISO 11654 - Clasa D <table border="1"> <thead> <tr> <th>Frecvența f (Hz)</th> <th>125</th> <th>250</th> <th>500</th> <th>1000</th> <th>2000</th> <th>4000</th> </tr> </thead> <tbody> <tr> <td>Baffles 1200 x 300mm</td> <td></td> <td></td> <td></td> <td></td> <td></td> <td></td> </tr> <tr> <td>α_p Distanța dintre șiruri 300mm</td> <td>0.15</td> <td>0.25</td> <td>0.45</td> <td>0.90</td> <td>0.90</td> <td>0.95</td> </tr> </tbody> </table> NRC = 0.65 (300mm) conform ASTM C 423		Frecvența f (Hz)	125	250	500	1000	2000	4000	Baffles 1200 x 300mm							α_p Distanța dintre șiruri 300mm	0.15	0.25	0.45	0.90	0.90	0.95
Frecvența f (Hz)	125	250	500	1000	2000	4000																		
Baffles 1200 x 300mm																								
α_p Distanța dintre șiruri 300mm	0.15	0.25	0.45	0.90	0.90	0.95																		
Reacția la foc		Euroclass A2-s1,d0 conform EN 13501-1																						
Rezistența la umiditate		90%																						
Calitatea aerului		 A+	 E1	 IACG																				
Curățare																								
Sustenabilitate		BIODEGRADABLE WOOL EC 1272/2008 Annex G																						

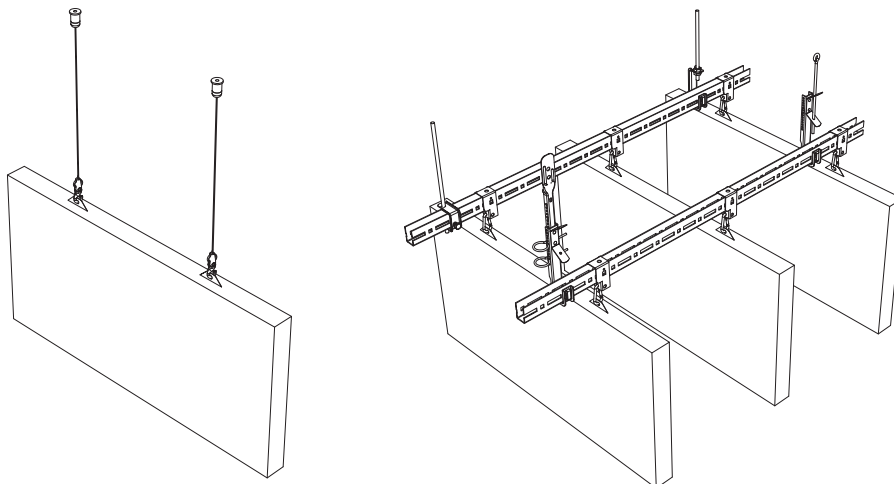

vd Opțiunile cu acest simbol sunt disponibile în gama noastră **Vario Design**.

Disponibilitatea produsului poate să difere de la țară la țară.

Pentru mai multe informații vă rugăm să vă adresați către reprezentantul dvs. local de vânzări.

Mai multe informații precum și indicații de ordin legal găsiți pe pagina noastră de internet.

knaufceilingsolutions.com

08/2022