



Sistemi a baffle verticali

## METAL Baffle Element

(METAL Baffle / V-P 500)













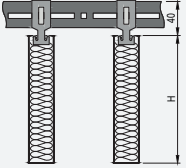







































Singolo / Accoppiato



- Soluzioni **METAL Baffle Element** vengono solitamente usate per controsoffitti acustici adatti a spazi a pianta aperta molto frequentati e rumorosi, come aeroporti, terminal ferroviari, edifici con intradosso semi-esposti, uffici, negozi, centri ricreativi, ecc.
- Layout lineare
- Soluzione interamente configurabile con spaziatura variabile dei baffles.
- Diverse combinazioni di altezze dei baffles e installazioni radiali possibili.
- Soluzione adatta a corridoi.
- Facile e veloce da installare con cavi di sospensione regolabili (singoli).
- Installati su un sistema a Profilo U per un perfetto allineamento e coperture facciali opzionali iraggruppate.
- Consegnato con un cuscinetto acustico montato all'interno.
- Ulteriori dimensioni e opzioni disponibili a richiesta.
- Semplice integrazione dei servizi nello spazio del controsoffitto.
- Ulteriori opzioni di design disponibili nell'ambito della nostra gamma **Vario Design**.



Sistemi a baffle verticali  
**METAL Baffle Element**  
 Singolo / Accoppiato

<b>Dettagli dei bordi</b> 	<b>METAL Baffle Element [Singolo]</b> 	<b>METAL Baffle Element [Raggruppato]</b> 
<b>Sistema</b> 	METAL Baffle, kit fili per appendimento (lunghezza 4000 mm) Mascherine e connettori disponibili come articoli separati. Non in dotazione.	
<b>Dimensioni (mm)</b> 	1800 x 300 x 30 Disponibile in 2 pezzi/cartone.	Lunghezza baffle: varie dimensioni Larghezza baffle: 30 Altezza baffle: 150 / 200 / 250 / 300
<b>Materiali e perforazioni</b> 	Acciaio zincato post-verniciato, 0.7mm <div style="display: flex; justify-content: space-around; align-items: flex-start;"> <div style="text-align: center;">                       Non perforato                 </div> <div style="text-align: center;">                       Perforazione standard  <b>Rg 2516</b>  <small>Ø: 2.5mm Area aperta: 16%</small> </div> <div style="text-align: center;">                       Microperforazione  <b>Rd 1522</b>  <small>Ø: 1.5mm Area aperta: 22%</small> </div> <div style="text-align: center;">                       Extra-microperforazione  <b>Rg 0701</b>  <small>Ø: 0.7mm Area aperta: 1.5%</small> </div> </div> <p style="text-align: right; font-size: small;">(entrambi i lati verticali) Tappetino acustico 25 mm, 25 kg/m<sup>3</sup></p> <div style="border: 1px solid #0070C0; padding: 2px; margin-top: 5px;"> <b>vd Altre perforazioni</b> </div> <div style="display: flex; justify-content: space-around; font-size: x-small;"> <div> Rd 1511</div> <div> Rg 1511</div> <div> Rg 1821</div> <div> Rg 3013</div> <div> Qg 4025</div> </div>	
<b>Colori</b> 	<div style="display: flex; justify-content: space-between;"> <div style="width: 30%;">                       RAL 9010                 </div> <div style="width: 40%; border: 1px solid #0070C0; padding: 2px;"> <b>vd Vari colori di design</b> <div style="display: grid; grid-template-columns: repeat(8, 1fr); gap: 5px; font-size: x-small;"> <div> Granito</div> <div> Acciaio</div> <div> Marmo verde</div> <div> Rame</div> <div> Rovere</div> <div> Ottone</div> <div> Sabbia</div> <div> Cemento</div> <div> RAL 9003</div> <div> RAL 9005</div> <div> RAL 9006</div> <div> RAL 9007</div> <div> RAL 9016</div> </div> </div> <div style="width: 25%; border: 1px solid #0070C0; padding: 2px;"> <b>vd Effetti legno</b> <div style="display: grid; grid-template-columns: repeat(4, 1fr); gap: 5px; font-size: x-small;"> <div> Cenere</div> <div> Bambù naturale</div> <div> Bambù caramello</div> <div> Acero</div> <div> Rovere</div> <div> Ciliegio americano</div> <div> Noce americano</div> </div> </div> </div>	
<b>Peso</b> 	<div style="display: flex; justify-content: space-between; font-size: x-small;"> <div><b>Non perforato</b> 2.0 - 3.6 kg/lm</div> <div><b>Rg 2516</b> 1.7 - 3.1 kg/lm</div> <div><b>Rd 1522</b> 1.6 - 2.9 kg/lm</div> <div><b>Rg 0701</b> 1.9 - 3.5 kg/lm</div> </div> <p style="text-align: right; font-size: x-small;">Peso a seconda della perforazione e della lunghezza scelta.</p>	
<b>Acustica</b> 	Le prestazioni acustiche dipendono dall'altezza del baffle, dalla distanza grezza tra baffle e dalla distanza dall'intradosso. Valori acustici disponibili su richiesta.	
<b>Resistenza al fuoco</b> 	Euroclasse <b>A2-s1, d0</b> a norma EN 13501-1 <span style="float: right; font-size: x-small;">Valori applicabili solo per RAL 9010.</span>	
<b>Resistenza all'umidità</b> 	<b>90% RH</b>	
<b>Qualità dell'aria interna</b> 	<div style="display: flex; justify-content: space-around; font-size: x-small;"> <div> A</div> <div> E1</div> </div>	
<b>Pulibilità</b>	<div style="display: flex; justify-content: space-around; align-items: center;">      </div> <p style="text-align: center; font-size: x-small;">(solo non perforato)</p>	
<b>Sostenibilità</b>	<div style="display: flex; justify-content: space-around; align-items: center; font-size: x-small;">    </div> <p style="text-align: left; font-size: x-small;">≈14%</p>	

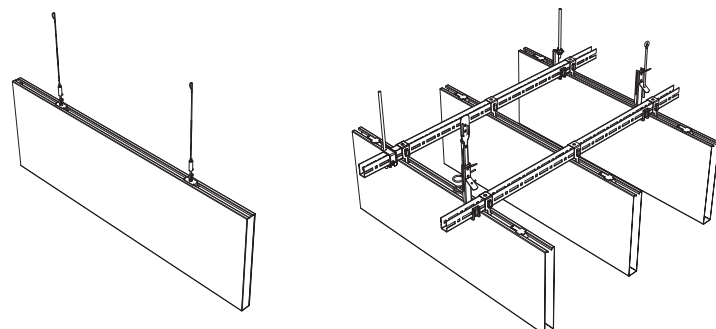

[Pagina precedente] METAL Baffle Element raggruppato (E&Y, Varsavia, Polonia, © Szymon Polański)

**vd** Le opzioni contrassegnate da questa icona sono disponibili dalla nostra gamma **Vario Design**. Alcune combinazioni di colori e/o perforazioni non sono disponibili per tutti i prodotti. I prodotti possono variare a seconda del Paese. Si prega di contattare l'agente di vendita locale. Per ulteriori informazioni e note legali consultare il nostro sito web.  
[knaufceilingsolutions.com](http://knaufceilingsolutions.com)