

Metal Profiles

Drywall Partitions, Wall Lining, & Shaftwall

Product-Data-Sheet

04/2026



Product Description

Knauf metal profiles are precision-engineered, high-quality steel sections that are used to form the metal substructure of the Knauf Drywall Systems. All metal sections produced from high-grade hot dip galvanized steel coils with the cold-rolled forming process in Knauf United Arab Emirates.

The main design criteria's for Knauf metal sections are:

- **Quality:** Knauf works with ISO 9001 certified raw material suppliers to guarantee its steel quality. High grade hot dip galvanized zinc coating (min. Z180 class) provides maximum protection against corrosion.
- **Sustainability:** Knauf is committed to environmental excellence, ensuring its production facilities and raw material partners adhere to ISO 14001:2015 standards for Environmental Management
- **Simplicity:** Minimum amount of accessories and 'twist to fit' studs and channels are designed to make the installer's job as simple as possible.
- **Compatibility:** Knauf metal sections are specially designed to work and perform together with Knauf gypsum boards and accessories to create complete, tested and certified systems
- **Variety:** A wide range of sizes and options allows designers to find solutions that exactly match their requirements.
- **Transparency:** All dimensions, thicknesses, lengths, coating, production dates, date & timing, country of origin, & manufacturing standard is printed.

Metal Profiles Raw Material Specification

Steel	Quality Classification	:	DX51D+Z180 as per EN 10327: 2004
	Yield Strength	:	295 Mpa
	Tensile Strength	:	345Mpa
	Elongation in 80mm	:	25%
	Hardness (HRB)	:	64
Protection	Method	:	Hot Dip Galvanization
	Quality	:	98% Zinc (Zn)
	Coating Classification	:	Z180 as per ASTM A653
	Coating Thickness	:	180gr/m ² both sides 10µ m single side
	Coating Finish	:	Regular Crushed Spangle
	Surface Quality	:	Skin passed
	Surface Treatment	:	Chromated

*Z180 is the standard coating thickness for Knauf Drywall Systems profiles. Higher coating thicknesses are available upon request. Contact Knauf Drywall Systems sales team for availability and delivery times.

Steel Character

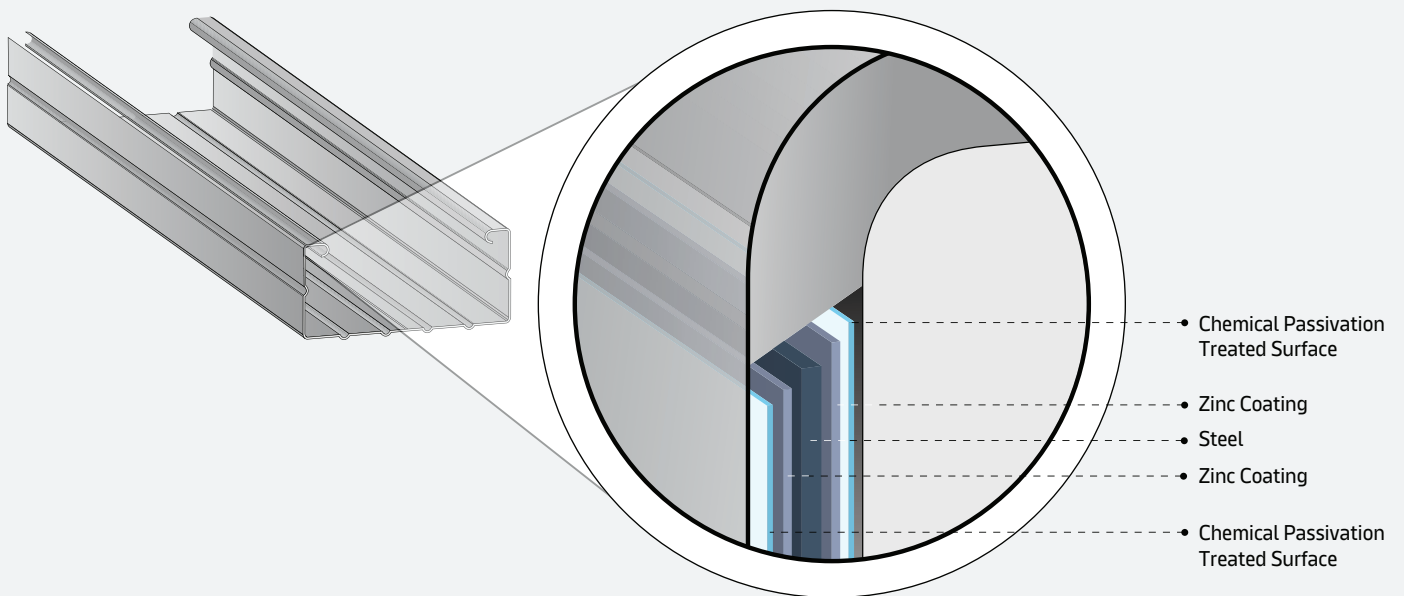

Metal Sections Application Areas

Partitions

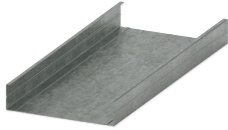

CW Studs

C shaped profiles friction fit at equal distances into the head and base UW channels to form the vertical metal stud frame

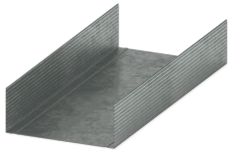

Deep Flange UW Tracks

U-Shaped profiles used to ceiling perimeter form where high deflection tolerance is required

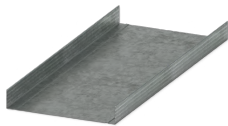

UW Tracks

U-shaped profiles used for forming the floor and ceiling perimeter frame in drywall partitions

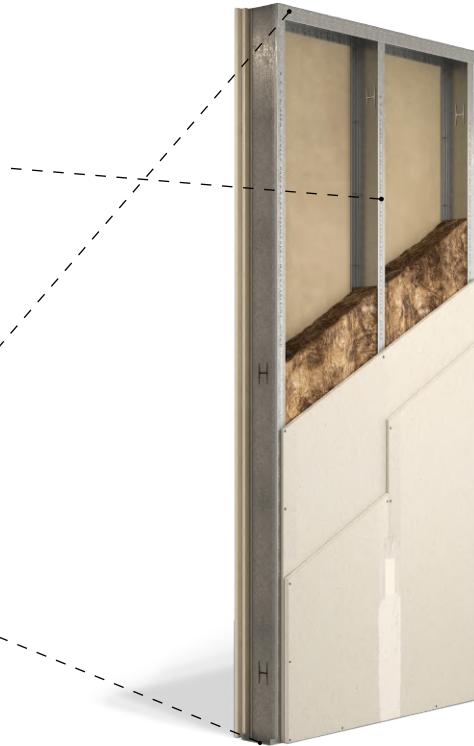

Wall Linings



CD 60/27 Channels

C-shaped channels used for vertical framing in Knauf W623 Wall Lining Systems



Universal Bracket

An adjustable brackets for Knauf W623 Wall Lining System. Can be cut and bend according to the cavity behind the board.

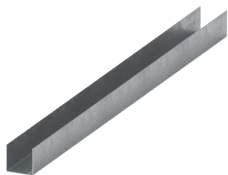

UD 28/27 Channels

U-Shaped channels used for perimeter framing for Knauf W623 wall lining systems

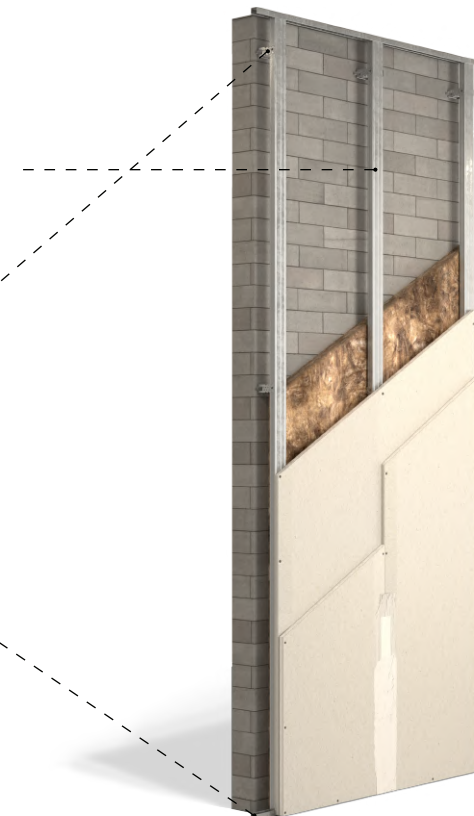

Shaftwalls



J Track

J shaped channels used to form the perimeter frame and also vertically for the end of the wall



C-T Studs

C-T shaped heavy duty steel sections used to form the vertical frame

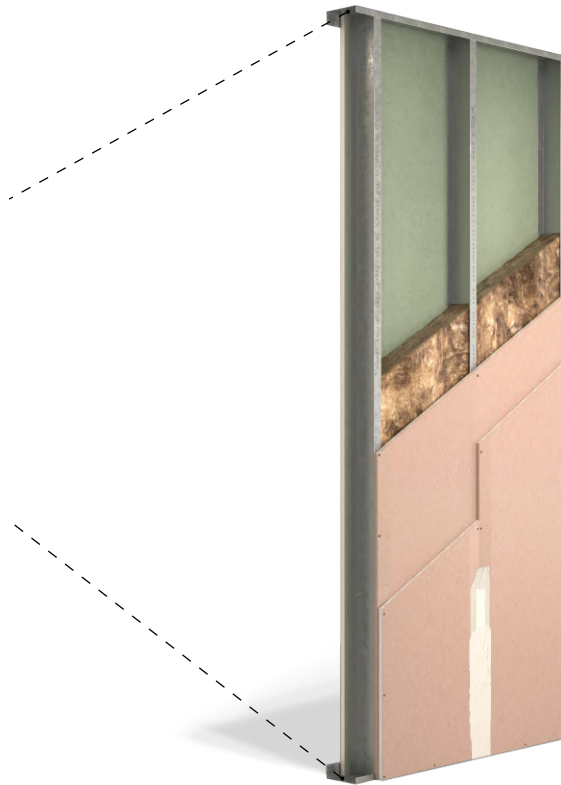

How to Identify a Metal Section On-Site

Our commitment to Continuous Quality

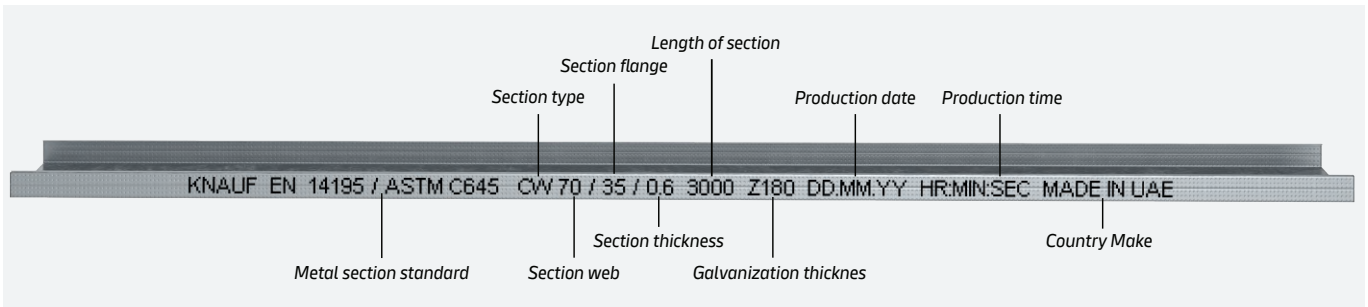

Example use of Knauf metal profiles in partitions

UD Channel

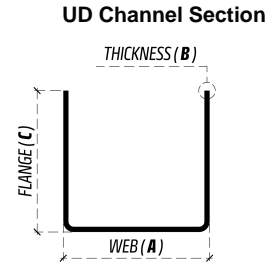
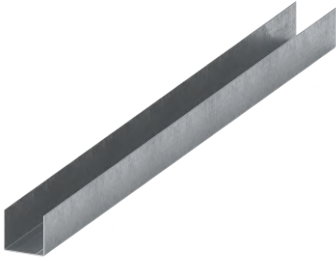

UD Channels are galvanized lightweight steel sections to be used as perimeter channels for Knauf D11 Ceiling Systems and also W623 Wall Lining Systems.

Mat.Code	Stud Type	Channel Web (a) (mm)	Channel thickness (b) (mm)	Channel Flange (c) (mm)	Channel Length ⁽¹⁾ (mm)	Weight (kg/m)	Zinc Coating Class ⁽²⁾ (g/m ²)
168480	Knauf UD Channel	28	0.6	27	3000	0.360	Z180

(1): Z180 is the standard retail zinc coating thickness sufficient for interior drywall applications. Higher zinc coated channel production also possible. For customized zinc coating requirements please contact Knauf LLC Sales Team.

Customer Service

UAE Tel: +971 4 33771700
8:00 - 17:30 (UAE Time)
Email:GCCcustomer.care@knauf.com
Email: GCCtechnical.care@knauf.com

HQ Address

Knauf LLC
Units B9 & B10 - LIU 6
Dubai Silicon Oasis
Dubai, UAE

Plant Address

P.O.Box 50006
Ras Al Khaimah, U.A.E.
Tel: +971 7 268 9837
Fax: +971 7 221 5301

Plant Address

Plot no - RY-PH02-M3-008
Raysut - WGS-84-Zone 39
Salalah Free Zone
Salalah, Dhofar, Oman



Observe safety data sheet!

For safety data sheets and CE labelling see
www.Knauf.com



Tender texts for all Knauf systems and products with export functions for Word and PDF.



Videos for Knauf systems and products can be found under the following link:
youtube.com/knauf



All information and documents from Knauf GCC are always up-to-date,

Knauf GCC

Dubai, United arab Emirates

Hotline

800 - KNAUF(56283)

www.knauf.com

Subject to technical changes. The current edition applies. The information contained herein corresponds to our current state of the art. The generally recognised rules of construction technology, relevant standards, guidelines and trade regulations must be observed by the contractor in addition to the processing instructions. Our warranty relates only to the flawless quality of our material. Consumption, quantity and execution data are empirical values that cannot be transferred without further ado in the event of deviating conditions. All rights reserved. Changes, reprinting and photomechanical and electronic reproduction, even in extracts, require our express authorisation.

The structural, static and physical properties of Knauf systems can only be guaranteed if only Knauf system components or products recommended by Knauf are used.

Build on us.