

KNAUFINSULATION

Rocksilks[®] Soffit Linerboard
Installation guide

knauf.com

What you need to know

Build on us.

Contents

Safety considerations	3
Typical systems	4
Pre-installation considerations	5
Installation sequence	10
Fixing	11
Cutting	16
Maintenance	18

Safety considerations

STORAGE

Rocksilk® Soffit Linerboards should be stored properly and handled in such a way as to ensure that they are clean and undamaged.

Rocksilk® Soffit Linerboards are supplied in polythene packs (4-LDPE) or shrink-wrapped pallets, which are designed for short-term protection only. For longer term protection on site the product should either be stored indoors or under cover and off the ground.

Rocksilk® Soffit Linerboards should not be left permanently exposed to the elements.

If the main hood is removed or damaged, the remaining packs should be kept under cover indoors or protected from the elements by a weatherproof cover. In coastal locations where weather is more extreme and bird damage is more common, use additional covering or store indoors.

The product must be protected from prolonged exposure to sunlight, and stored dry and flat.



Slabs protected from weathering potential

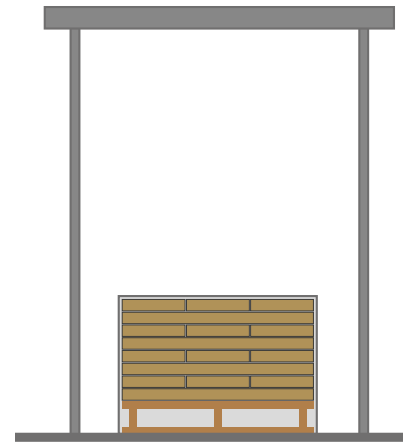

HANDLING

Rocksilk® Soffit Linerboards are easy to handle; care should be exercised to avoid crushing the edges or corners. If damaged, the product should be discarded. Damaged, contaminated or wet product must not be used.

During construction exposed areas of slabs should always be covered at the end of a day's work or in heavy rain. Polyethylene covers should be used to provide protection and prevent work from becoming saturated.



Slabs exposed to the elements

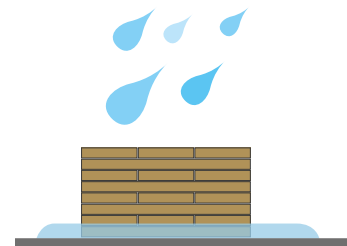

SAFETY EQUIPMENT AND TOOLS

It is recommended that the following Personal Protective Equipment and tools should be used while handling the product:

PPE: Gloves, dust mask (FFP1 minimum), safety glasses

Tools: Drill, knife or fine-toothed saw, tape measure

It is recommended that dust masks, gloves and long-sleeved clothing should be worn during cutting and handling of the product.

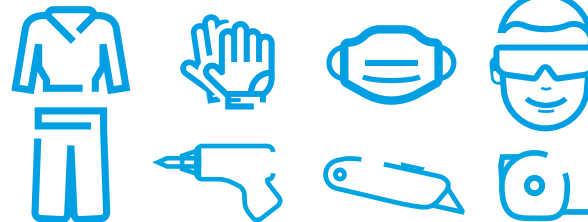

SOFFIT USING A CONCRETE DECK



SOFFIT USING A METAL COMPOSITE DECK



Pre-installation considerations



LAYOUT

Joints between slabs should be staggered by a minimum of 150mm and coincidental joints should be avoided.

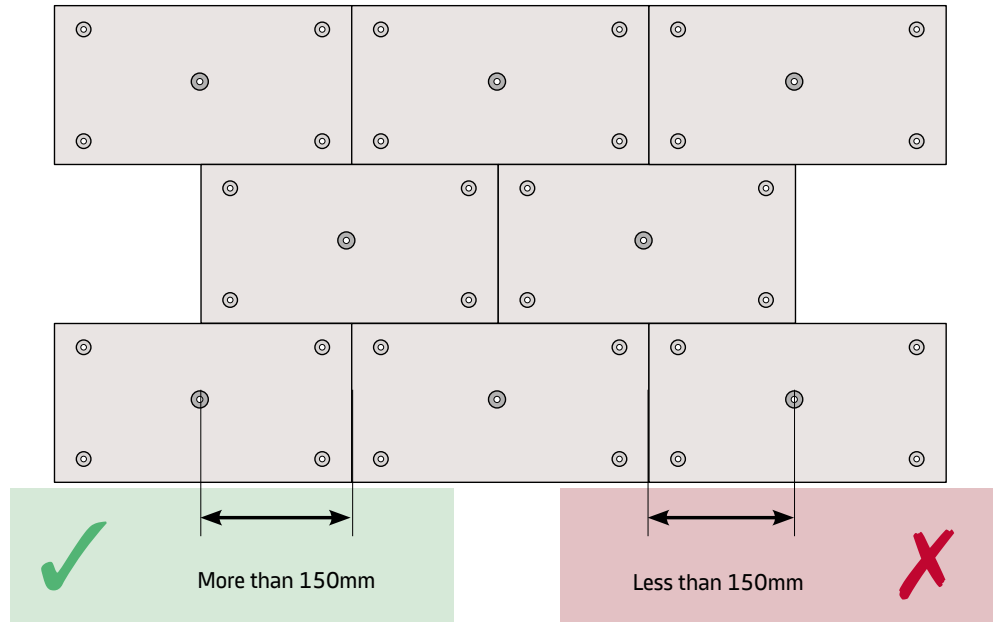

To avoid coincidental joints



-  TUBE WASHER
-  METAL FIXING
-  SLAB

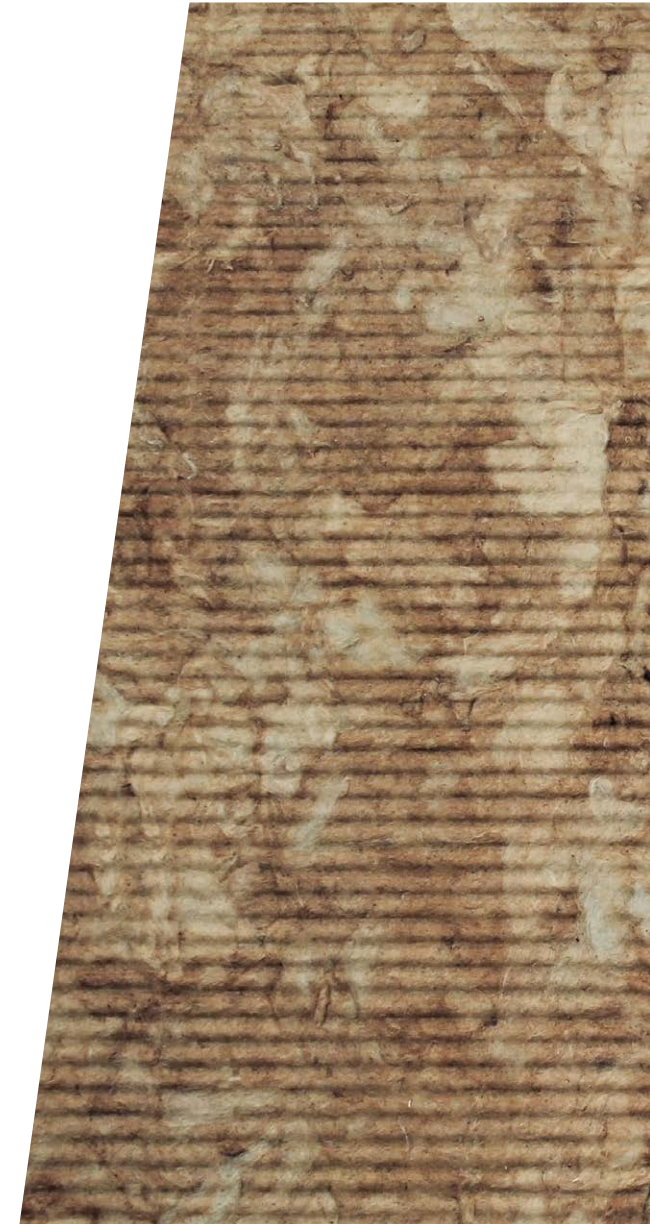

Pre-installation considerations

SLABS TO BE IN CONTACT WITH EACH OTHER

Rocksilk® Soffit Linerboards should be installed so they are tightly butted together at joints, staggered by a minimum of 100mm.

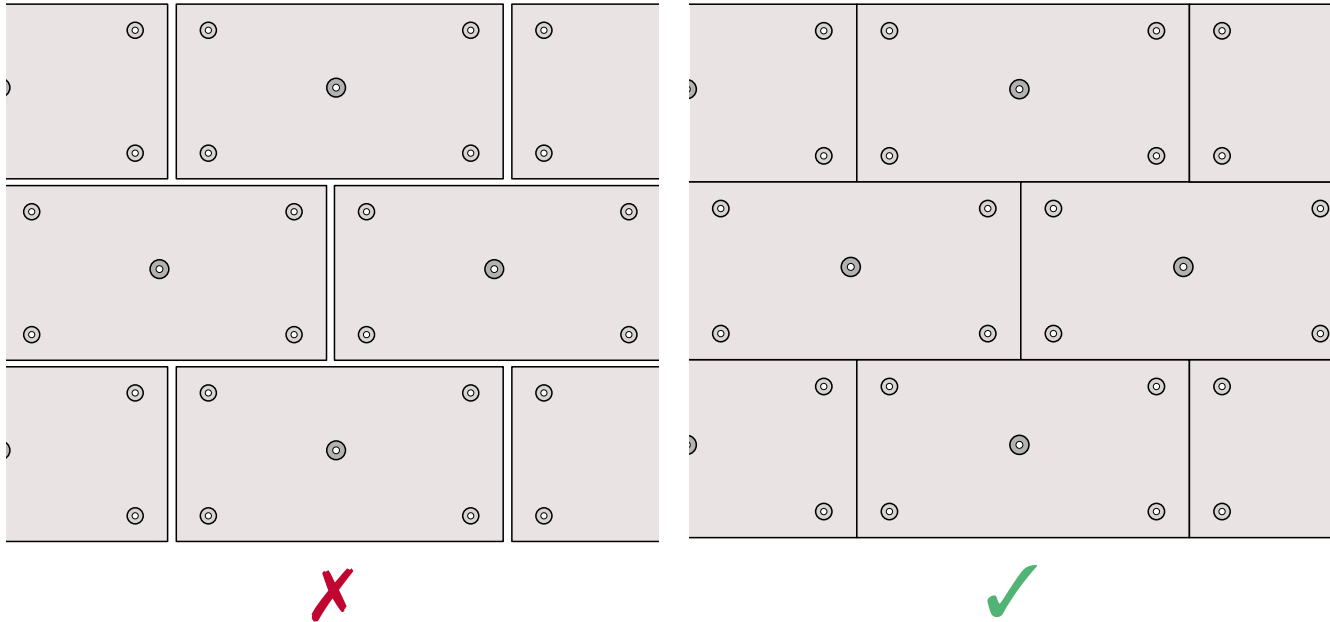

To ensure the insulation performs as thermally specified.



Pre-installation considerations

COMPRESSION FIT INTO PLACE

Ensure slabs are tightly butted, and if cut, cut slightly oversize and compression fit into place, making sure of a snug fit.

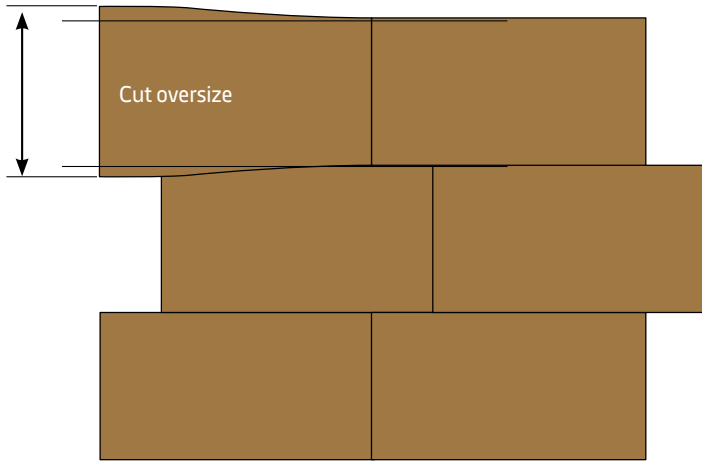

To create a tight knit between slabs, to reduce the chance of air gaps and ensure thermal efficiency.

INTIMATE CONTACT WITH SUBSTRATE

Slabs should be in intimate contact with the building substrate. The nature of the insulation material lends itself to accommodate any irregularities in the surface of the substrate.

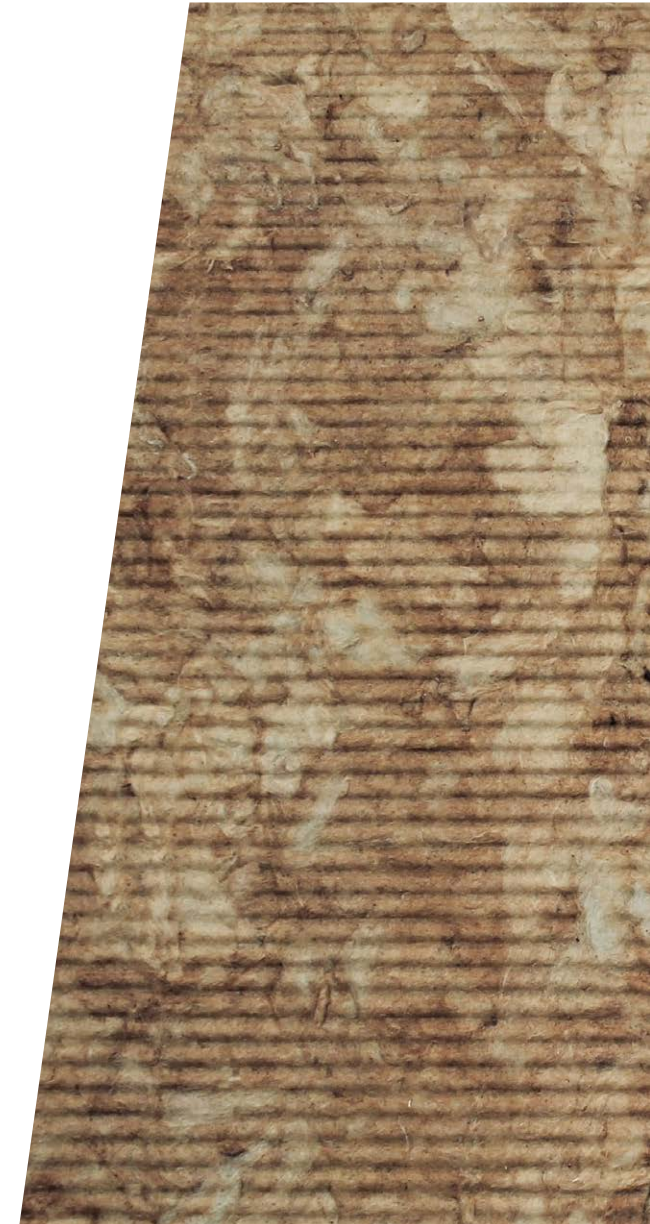
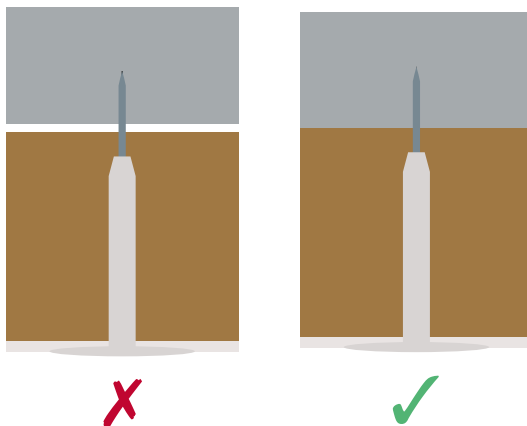

Pre-installation considerations

STEPS IN SOFFIT – ROCKSILK® SOFFIT LINERBOARD EXTRA

When steps in the soffit are seen when installing Rocksilk® Soffit Linerboard Extra the following process should be followed to ensure that the finished installation performs as intended from a thermal and aesthetical perspective.

Firstly a section of insulation should be trimmed from the edge of the slab, equal to the thickness of insulation being installed. The next slab should then be cut to size to fit into the recess created and the final slab butted tightly to the cementitious facing.

Care should be taken to ensure that all fixings are fixed directly into the soffit substrate and not into other slabs. One metal fixing per board is recommended for all slabs, whether full or sections of slabs.

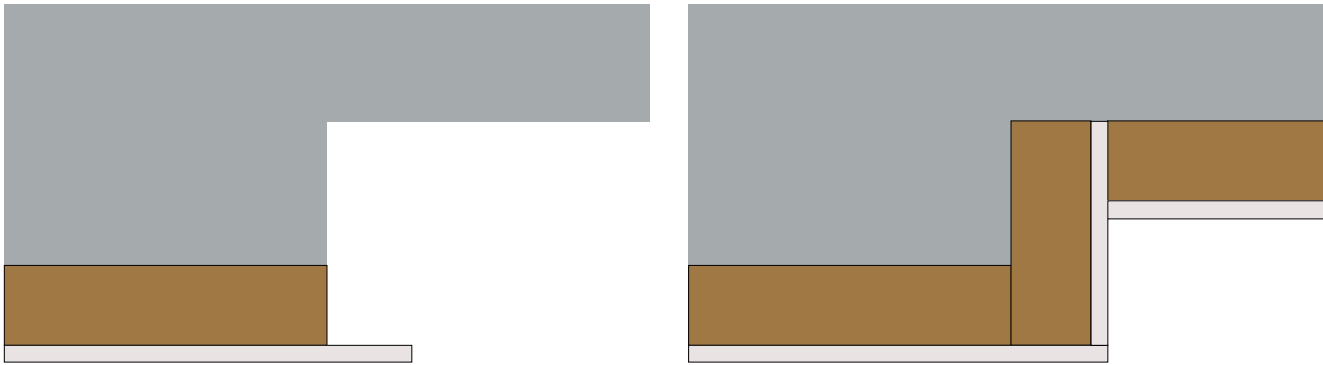

STEPS IN SOFFIT – ROCKSILK® SOFFIT LINERBOARD STANDARD

When steps in the soffit are seen when installing Rocksilk® Soffit Linerboard Standard the following process should be followed to ensure that the finished installation performs as intended from a thermal and aesthetical perspective.

The first slab should be mitred at 45 degrees to the step in the substrate, this can be done using a sharp bladed knife or a small toothed saw.

The following slab should be mitred at 45 degrees again and tightly butted to the first slab to ensure a tight fit. At this stage the joint can be taped using an appropriate tape. To finish the process the final slab can be tightly butted to the black tissue facing to ensure a tight fit between the slabs.

Care should be taken to ensure that all fixings are fixed directly into the soffit substrate and not into other slabs. One metal fixing per board is recommended for all slabs, whether full or sections of slabs.

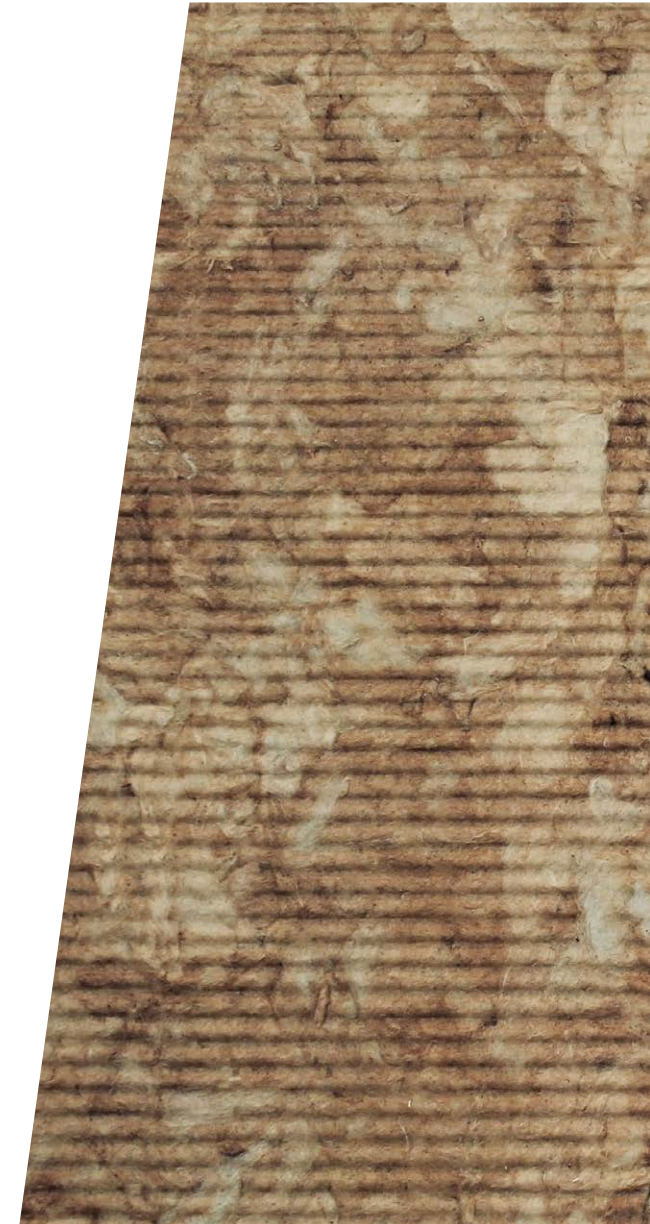
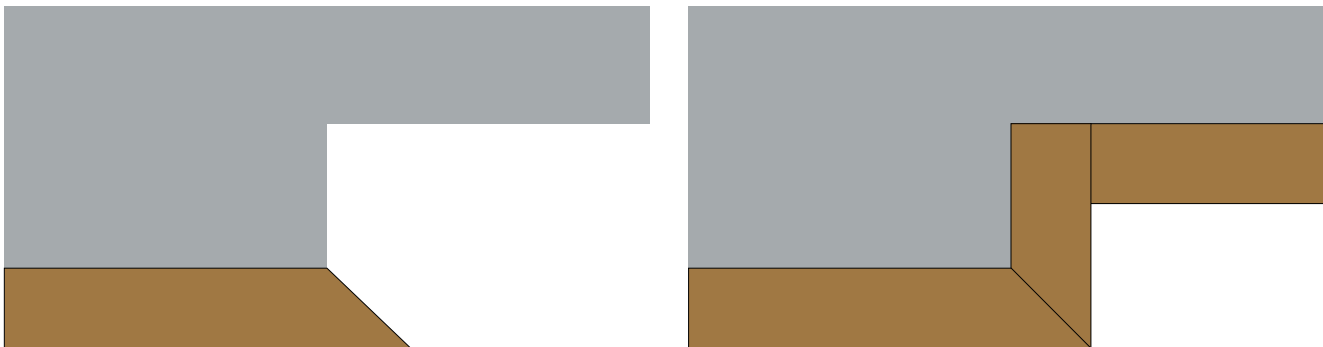

Pre-installation considerations

EXPOSED SOFFITS

Rocksilk® Soffit Linerboard Extra should be used in cases when the soffit will be in an exposed or semi exposed environment. This is because the cementitious particle board facing provides an enhanced weatherproof facing while further protecting the insulation by acting as a highly impact resistant layer.

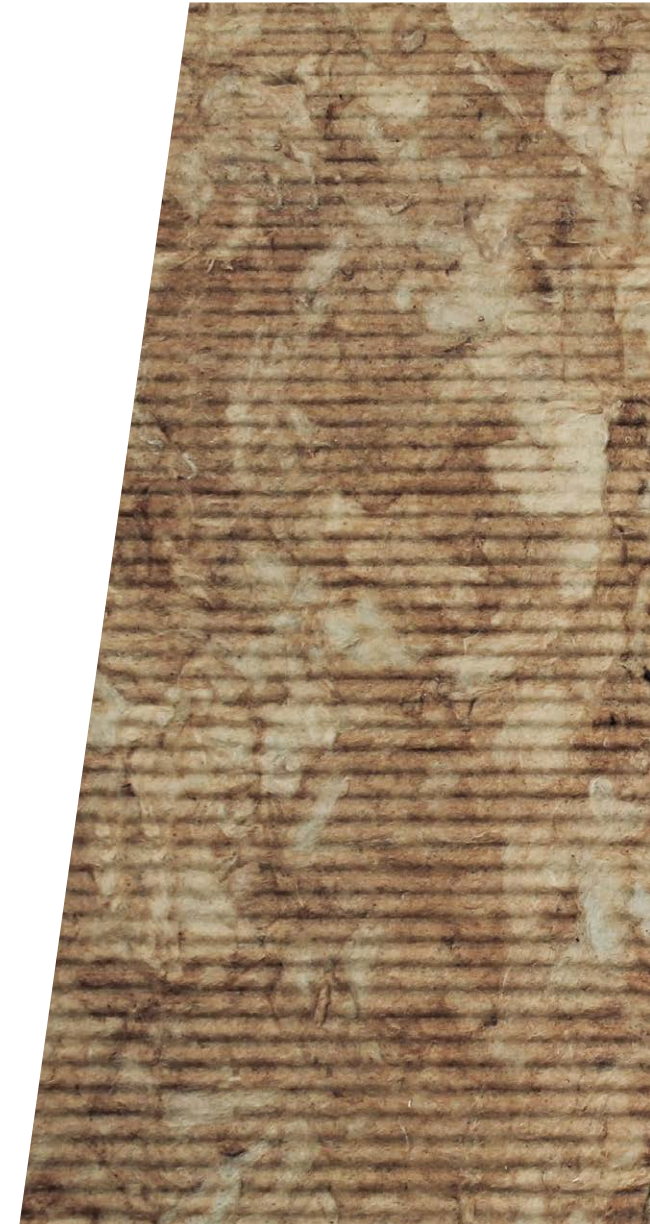

Installation sequence

PROCESS

Installation of both RocksilK® Soffit Linerboard Standard and Extra should be done by starting in one corner and working across the soffit to finish in the adjacent corner. A singular row of slabs should be installed first to create a straight line from which to butt up against.

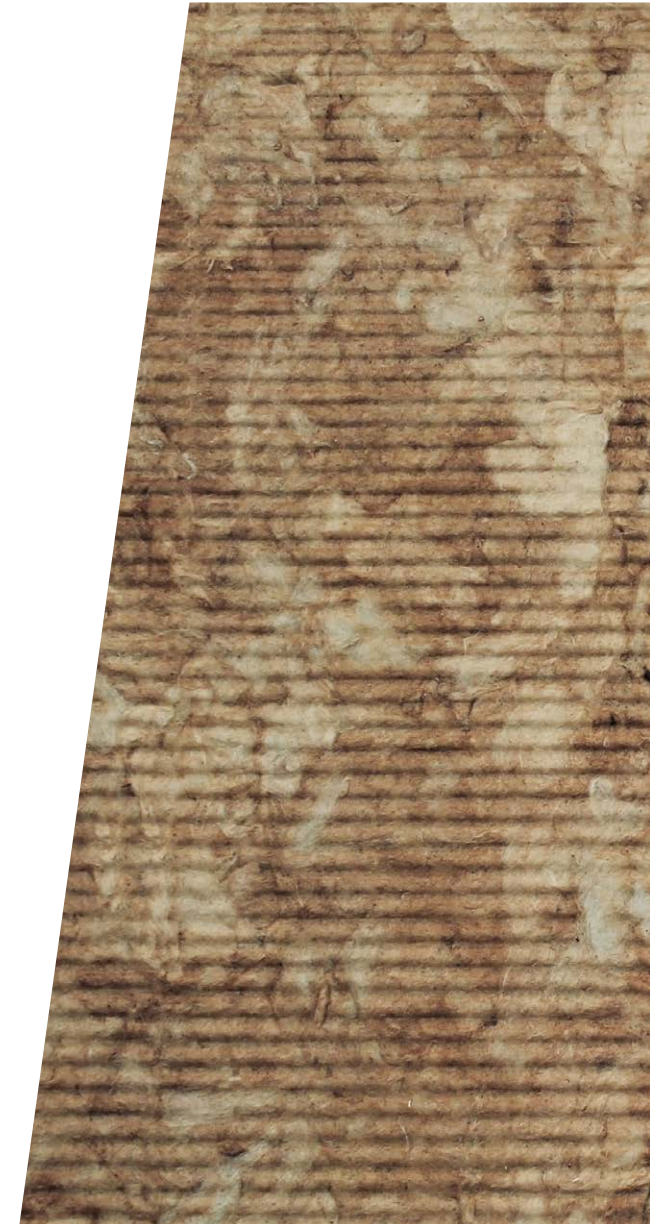
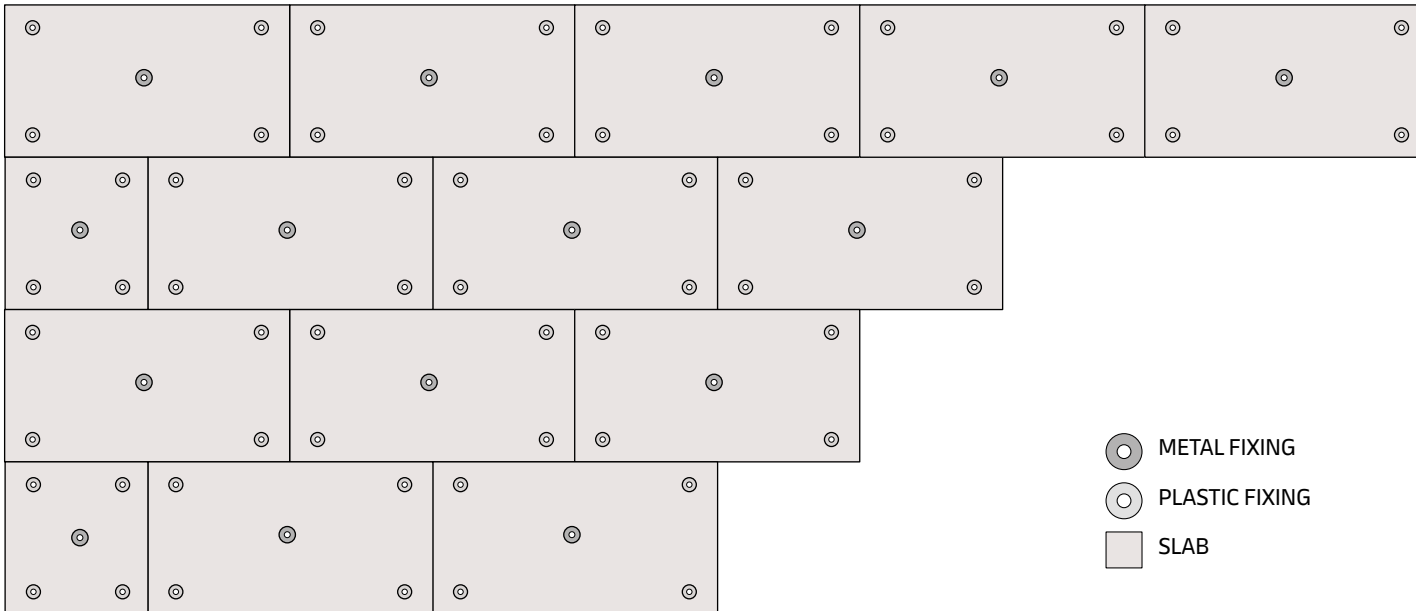

FIXING PATTERN

Rocksilk® Soffit Linerboards are available in 1200x600mm slabs and it is recommended that they are fixed into position using Rocksilk® Soffit Linerboard Fixings with five fixings per board. This should be done using one steel fastener in the centre of the slab and four perimeter fixings at each corner, minimum 50mm from each corner.



Five metal fixings provide suitable support to stop the insulation from sagging over time.

MECHANICAL FIXINGS

Due to the nature of this application, multiple different fixing types are available. Any fixings approved by the fixing manufacturer may be used to secure Rocksilk® Soffit Linerboards in position. Due to the variations in the specifications of concrete and other substrates, we advise that you seek specialist advice from the fixing manufacturer prior to installation for confirmation.

Five metal fixing arrangement

Using this method all perimeter, as well as the centre fixing, should be installed using metal screws and insulation washers.

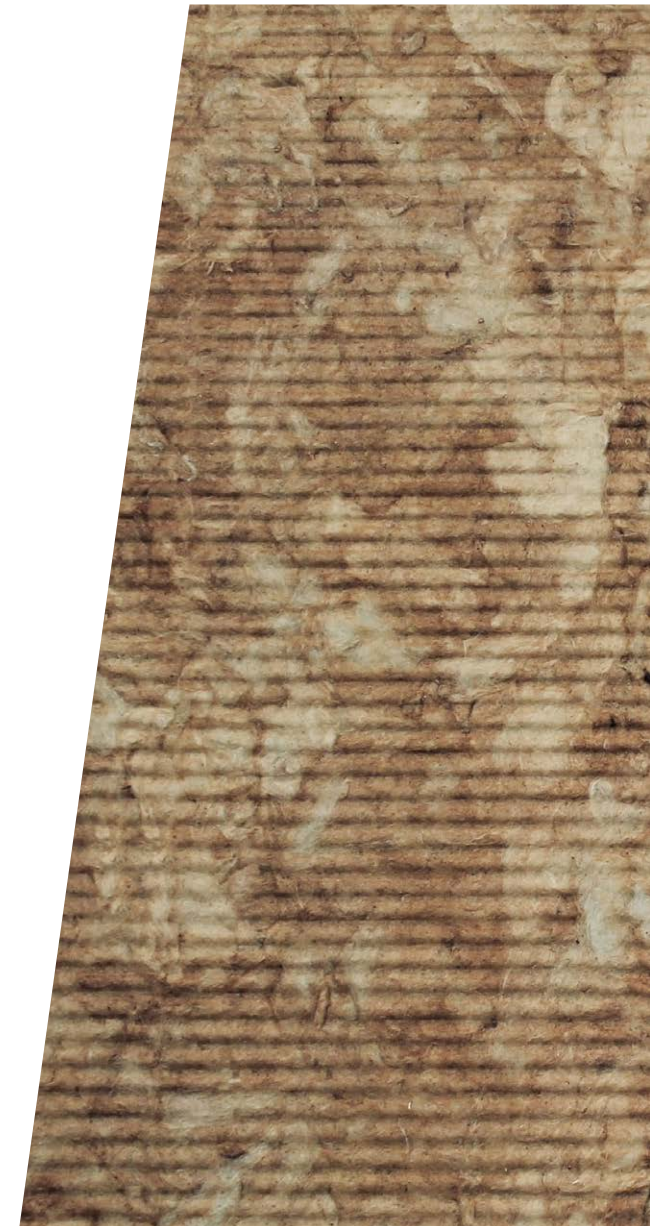
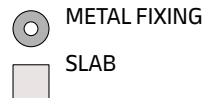
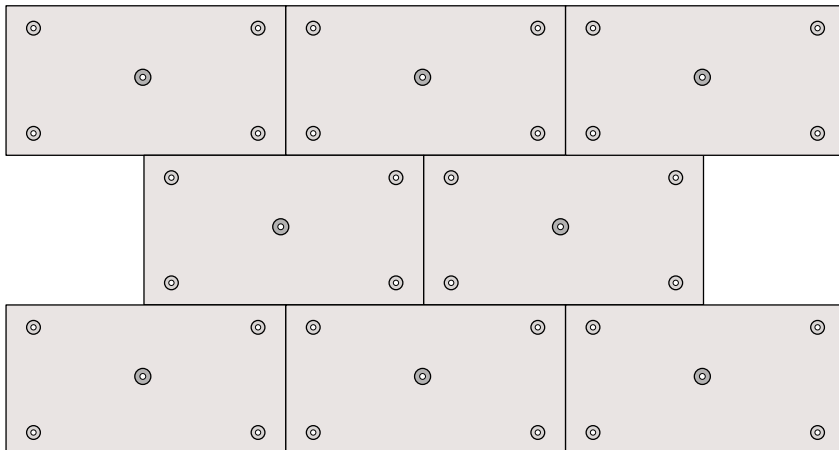
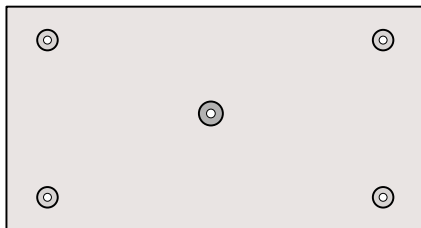

MECHANICAL FIXINGS

Tube washer arrangement

Rocksilk® Soffit Linerboards may also be installed using one centre metal fixing and four perimeter fixings being made up of tube washers.

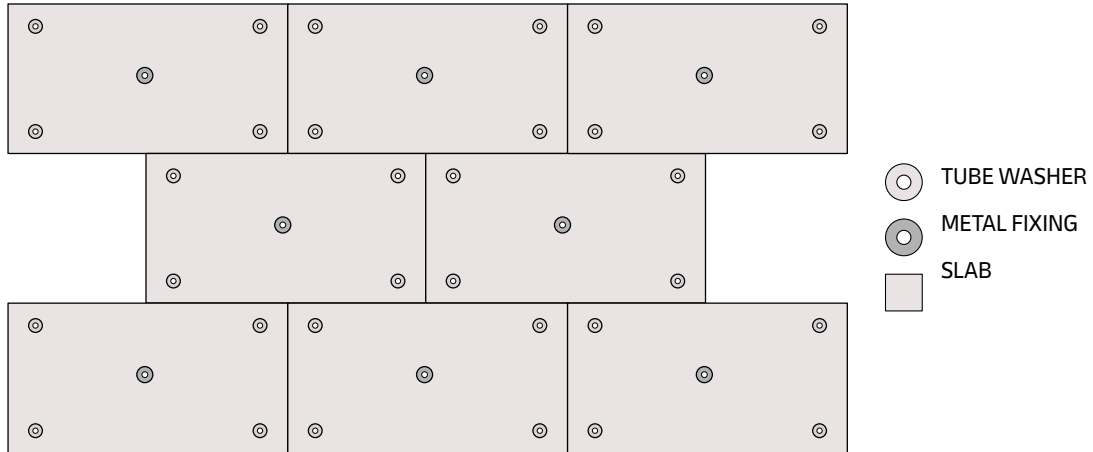

Tube washer length

A minimum of 15mm should be left between the end of the tube washer to allow for some compression and to stop the tube washer coming into contact with the substrate.

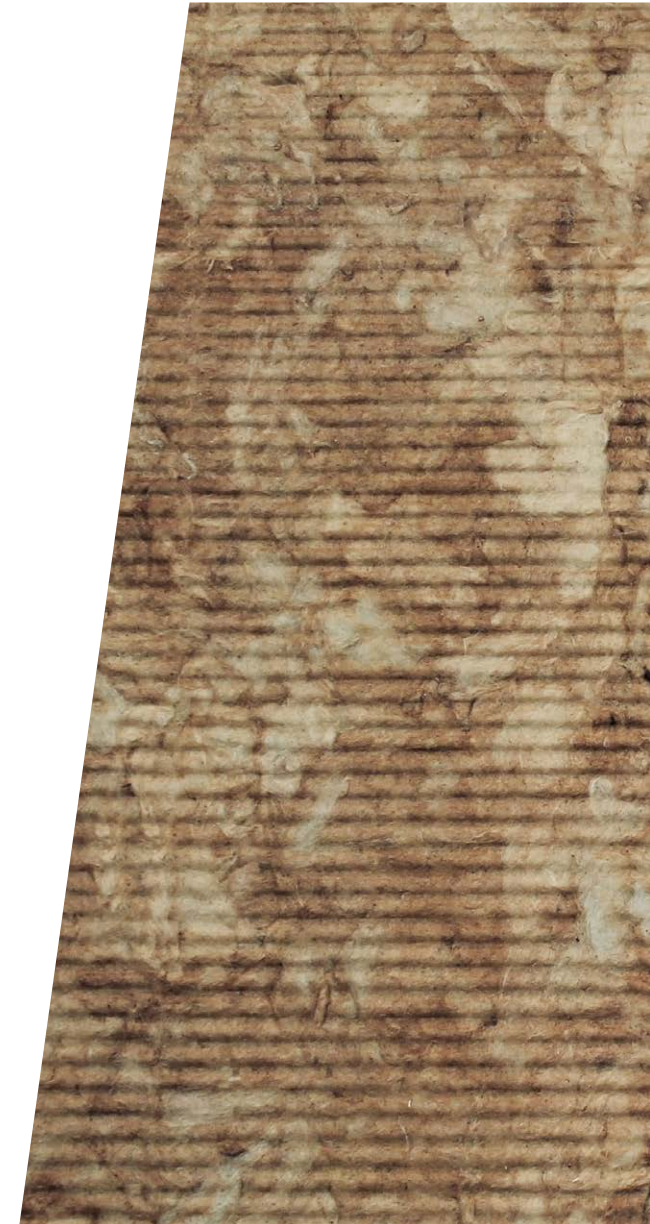
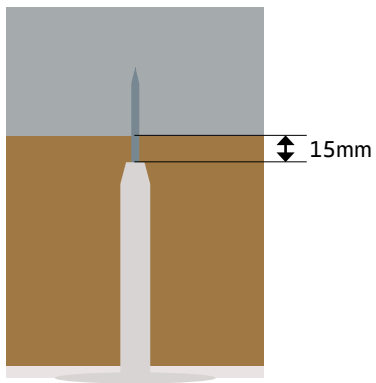

MECHANICAL FIXINGS

Tube washers with RocksilK® Soffit Linerboard Extra

When installing tube washers through RocksilK® Soffit Linerboard Extra a pilot hole big enough to push the tube washer through the cementitious board must be drilled. This can be done before or after the slab has been offered to the soffit.

Approved fixings

The table below details the combination of RocksilK® Soffit Linerboard Fixings for use with standard thicknesses of RocksilK® Soffit Linerboards. For details on bespoke thicknesses please contact our Technical Services Team.

RocksilK® Soffit Linerboard Standard thickness (mm)	Perimeter fix - plastic to concrete		Centre fix - metal to concrete	
	Tube Washer	Screw	Metal Washer	Screw
130	100mm Black	85mm	70mm Black	175mm
160	125mm Black	85mm	70mm Black	200mm
185	150mm Black	85mm	70mm Black	225mm
220	200mm Black	75mm	70mm Black	250mm
270 (220 + 50)	250mm Black	75mm	70mm Black	300mm
RocksilK® Soffit Linerboard Extra thickness (mm)				
136	100mm White	100mm	70mm White	175mm
166	125mm White	100mm	70mm White	200mm
191	150mm White	100mm	70mm White	225mm
226	200mm White	85mm	70mm White	275mm
276 (226 + 50)	250mm White	85mm	70mm White	325mm

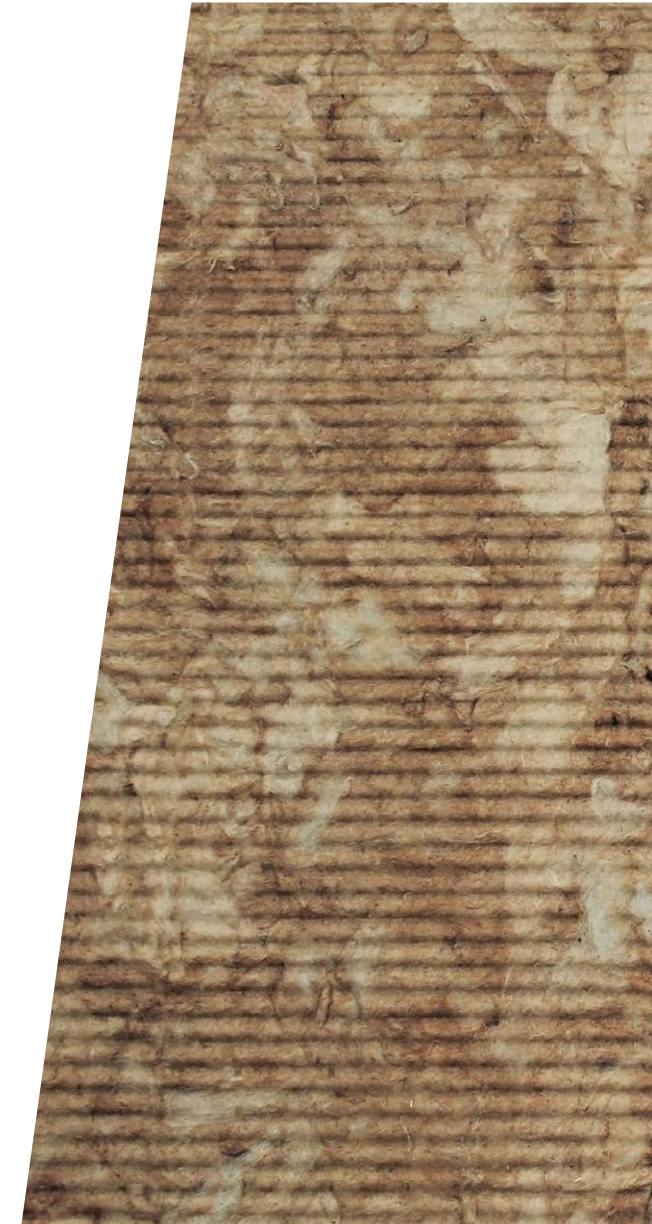

Fixing

FIXINGS MINIMUM HEAD DIAMETER OF 70mm

Provides optimum strength of fixing between substrate.

✓ Fixings 70mm or ABOVE

✗ Fixings BELOW 70mm

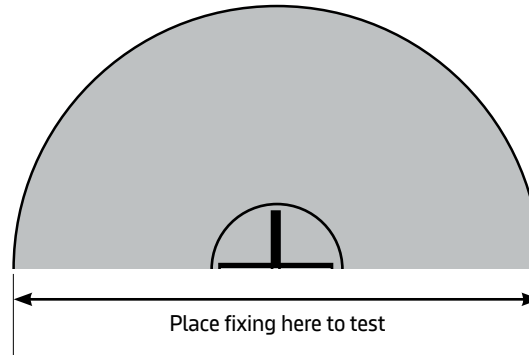

DON'T OVERTIGHTEN MECHANICAL FIXINGS

Ensure that mechanical fixings are not over tightened, surface compression of the product is not recommended.



This compromises the thermal performance and can impact the integrity of the black tissue facing.

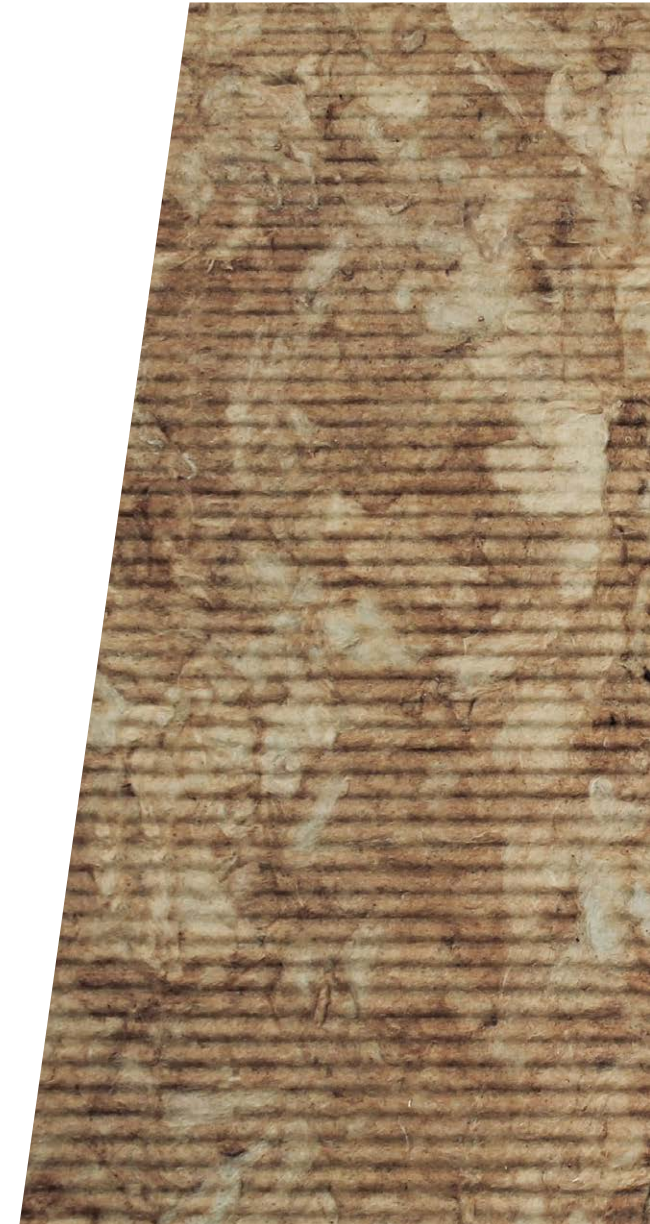
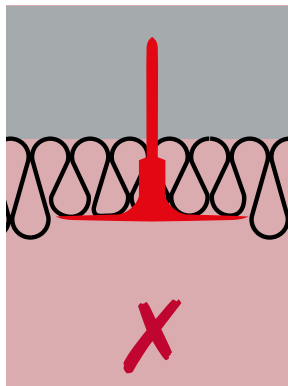
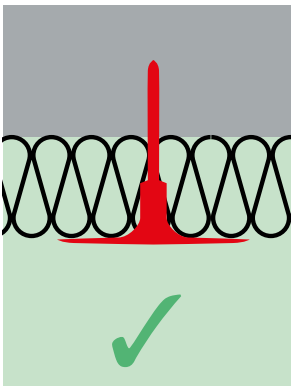

SUBSTRATES

When installing into a concrete or steel composite deck, a pilot hole should first be drilled before the fixing is screwed into position.

In the case of RocksilK® Soffit Linerboard Standard this can be done with or without the slab in its final position as the screw can be pushed through the insulation once the pilot hole has been drilled.

When installing RocksilK® Soffit Linerboard Extra a pilot hole must also be made in the cementitious particle board facing. This can be done at the same time as the substrate pilot hole with the board placed into its final position.

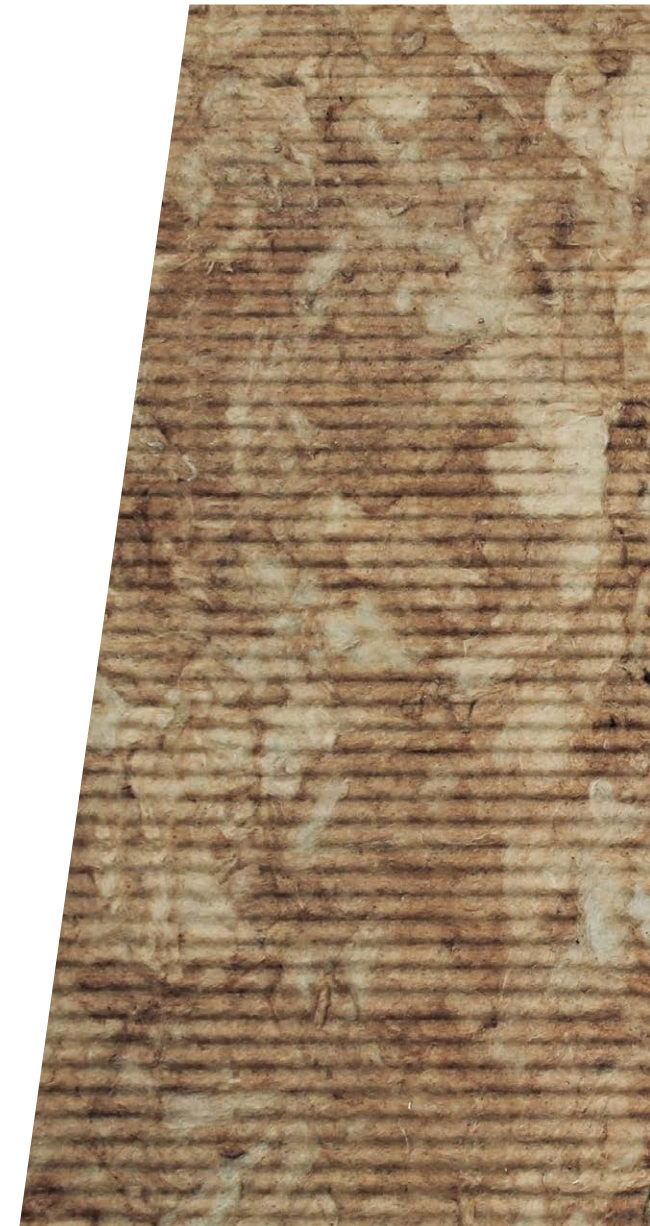
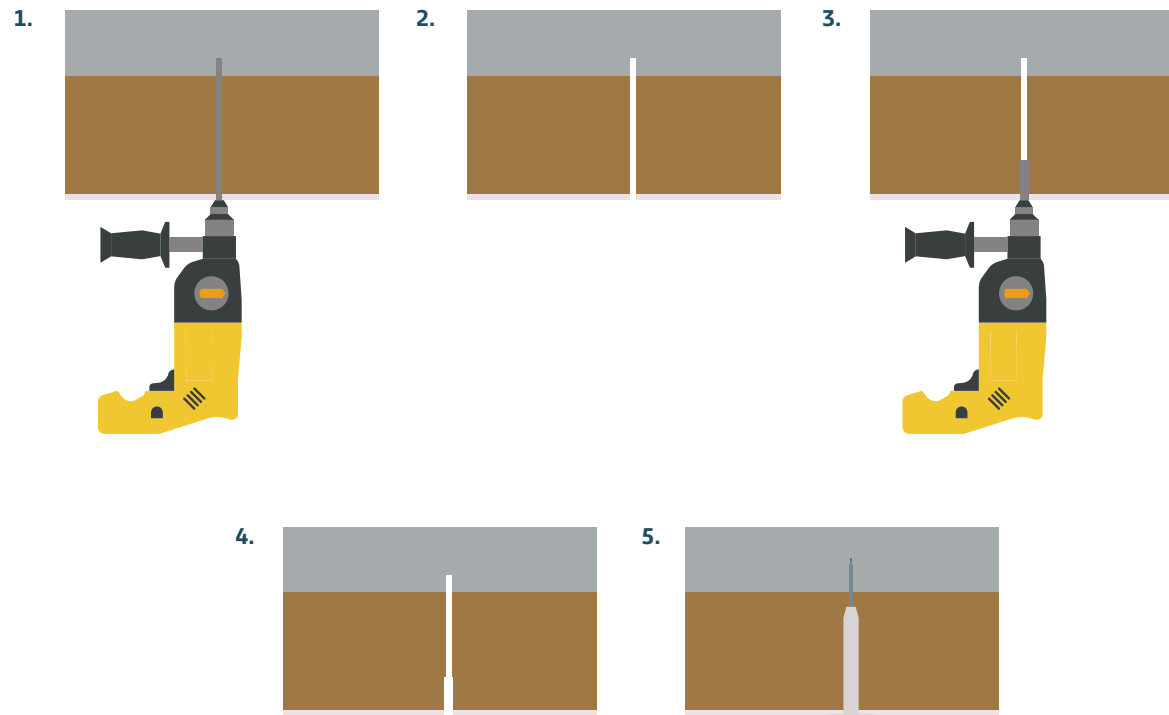

DUAL LAYERING WITH ROCKSILK® SOFFIT LINERBOARD

Rocksilk® Soffit Linerboard Standard or Extra can be installed in conjunction with 50 or 75mm Rocksilk® Soffit Linerboard Standard Unfaced to increase the total thickness of insulation installed, and to reduce the U-value of the finished ceiling.

The two layers should be installed in opposite orientations such that there are no coincidental joints, reducing the chances of gaps between the slabs which negatively affect the thermal performance

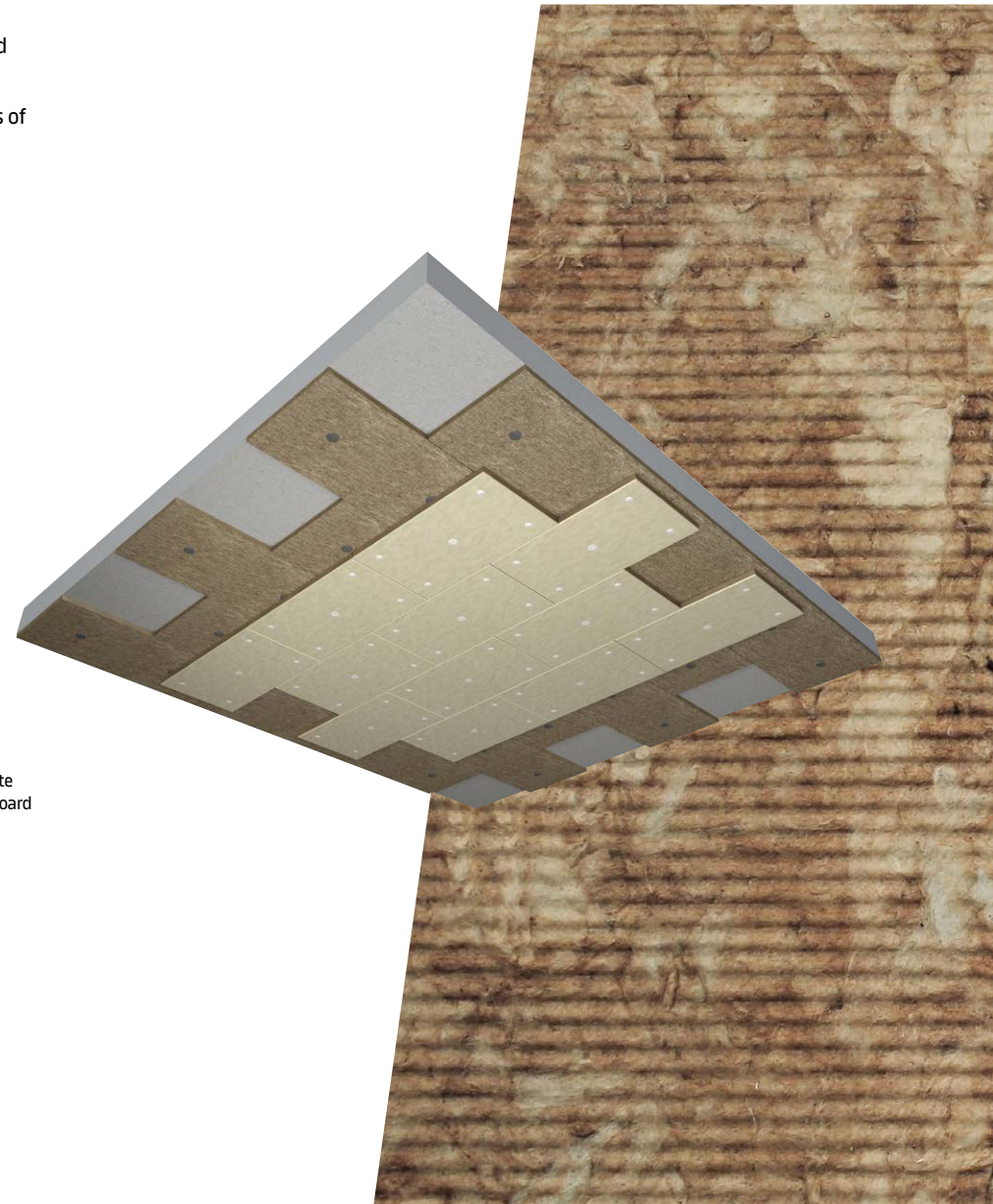
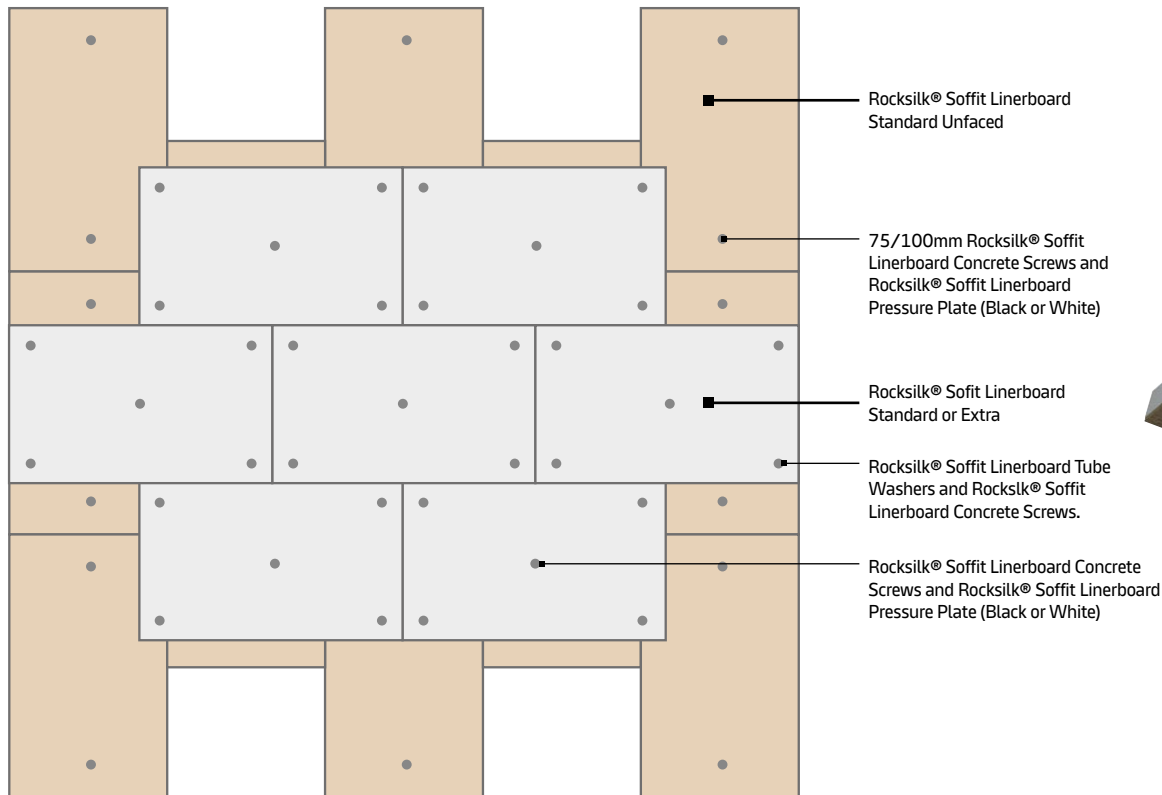

Insulation Thickness	Perimeter Fix - plastic to concrete		Centre Fix - plastic to concrete	
	Tube	Screw	Pressure Plate	Screw
225mm	200mm	75mm	70mm Black or White	250mm
230mm	200mm	85mm	70mm Black or White	275mm
235mm	200mm	85mm	70mm Black or White	275mm
240mm	200mm	100mm	70mm Black or White	275mm
245mm	200mm	100mm	70mm Black or White	275mm
250mm	200mm	100mm	70mm Black or White	275mm
255mm	150mm	175mm	70mm Black or White	300mm
260mm	150mm	175mm	70mm Black or White	300mm
265mm	125mm	200mm	70mm Black or White	300mm
270mm	125mm	200mm	70mm Black or White	300mm
275mm	125mm	200mm	70mm Black or White	300mm
280mm	125mm	225mm	70mm Black or White	350mm
285mm	125mm	225mm	70mm Black or White	350mm
290mm	125mm	225mm	70mm Black or White	350mm
295mm	125mm	225mm	70mm Black or White	350mm
300mm	125mm	225mm	70mm Black or White	350mm
305mm	200mm	175mm	70mm Black or White	350mm
310mm	200mm	175mm	70mm Black or White	350mm
315mm	200mm	175mm	70mm Black or White	350mm
320mm	200mm	175mm	70mm Black or White	350mm
325mm	200mm	175mm	70mm Black or White	350mm
330mm	200mm	200mm	70mm Black or White	400mm
335mm	200mm	200mm	70mm Black or White	400mm
340mm	200mm	200mm	70mm Black or White	400mm
345mm	200mm	200mm	70mm Black or White	400mm
350mm	200mm	200mm	70mm Black or White	400mm



Insulation Thickness	Perimeter Fix - plastic to concrete		Centre Fix - plastic to concrete	
	Tube	Screw	Pressure Plate	Screw
355mm	200mm	225mm	70mm Black or White	400mm
360mm	200mm	225mm	70mm Black or White	400mm
365mm	200mm	225mm	70mm Black or White	400mm
370mm	200mm	225mm	70mm Black or White	400mm
375mm	200mm	225mm	70mm Black or White	400mm
380mm	200mm	250mm	70mm Black or White	450mm
385mm	200mm	250mm	70mm Black or White	450mm
390mm	200mm	250mm	70mm Black or White	450mm
395mm	200mm	250mm	70mm Black or White	450mm
400mm	200mm	250mm	70mm Black or White	450mm
405mm	200mm	275mm	70mm Black or White	450mm
410mm	200mm	275mm	70mm Black or White	450mm
415mm	200mm	275mm	70mm Black or White	450mm
420mm	200mm	275mm	70mm Black or White	450mm
425mm	200mm	275mm	70mm Black or White	450mm

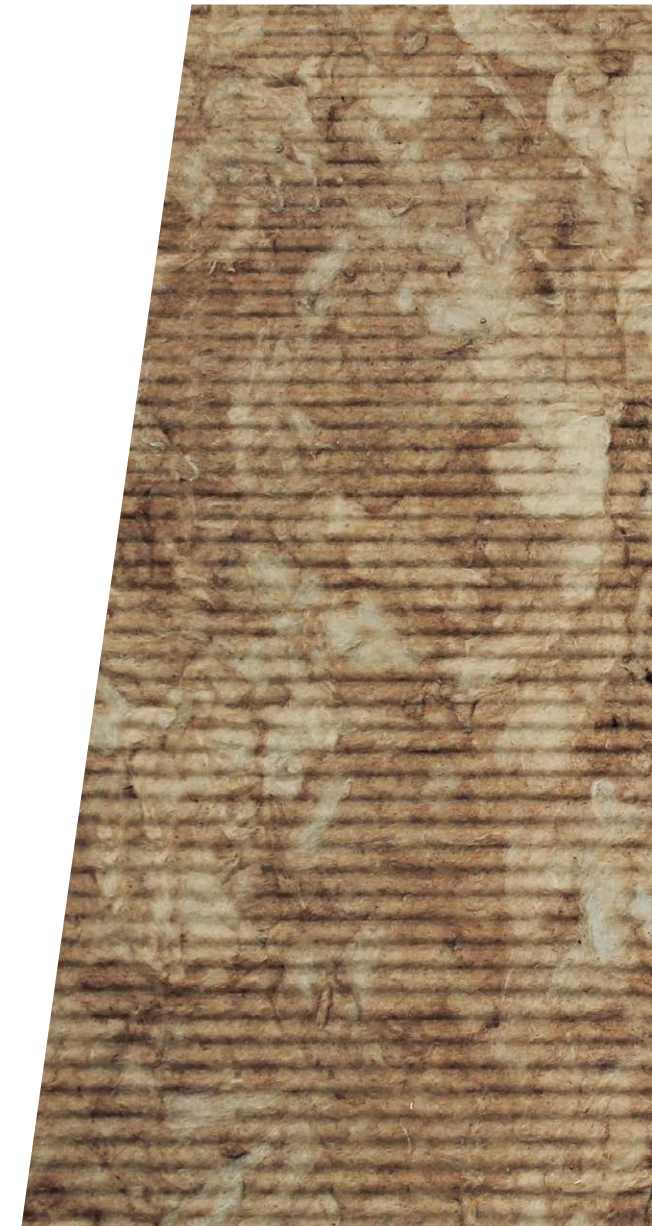

Cutting

CUT NEATLY AROUND PENETRATIONS AND CONSTRUCTION DETAILS

When installing Rocksilk® Soffit Linerboard Standard, cut oversize by 5mm to allow for some local compression of the slab around the feature to ensure a tight fit. Since the cementitious particle board facing on Rocksilk® Soffit Linerboard Extra does not allow for compression, care should be taken to cut around penetrations and details precisely.



To maximise thermal performance.



Leave 5mm overcut



Cut directly to penetrations

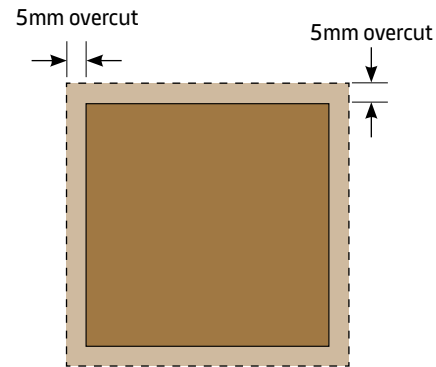

SEAL PERIMETERS

For both Rocksilk® Soffit Linerboard Standard and Extra areas that abut penetrations and perimeter walls can be sealed with a suitable mastic or sealant.



To form a good seal.

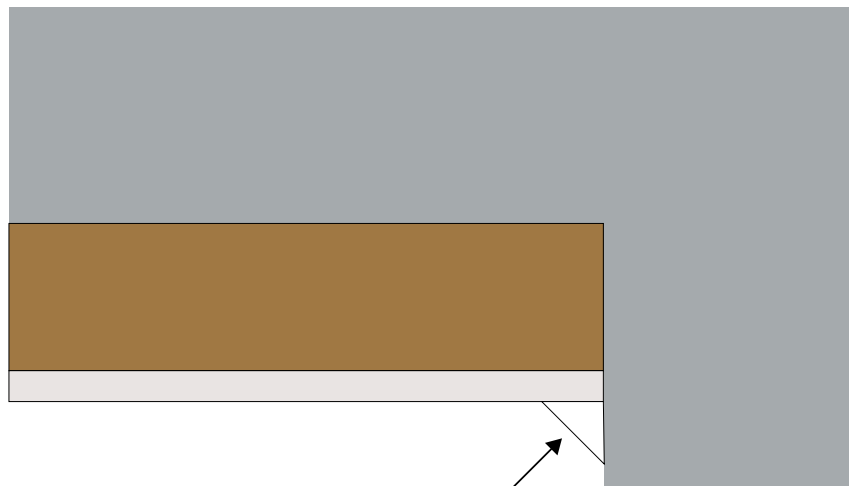

Mastic or sealant

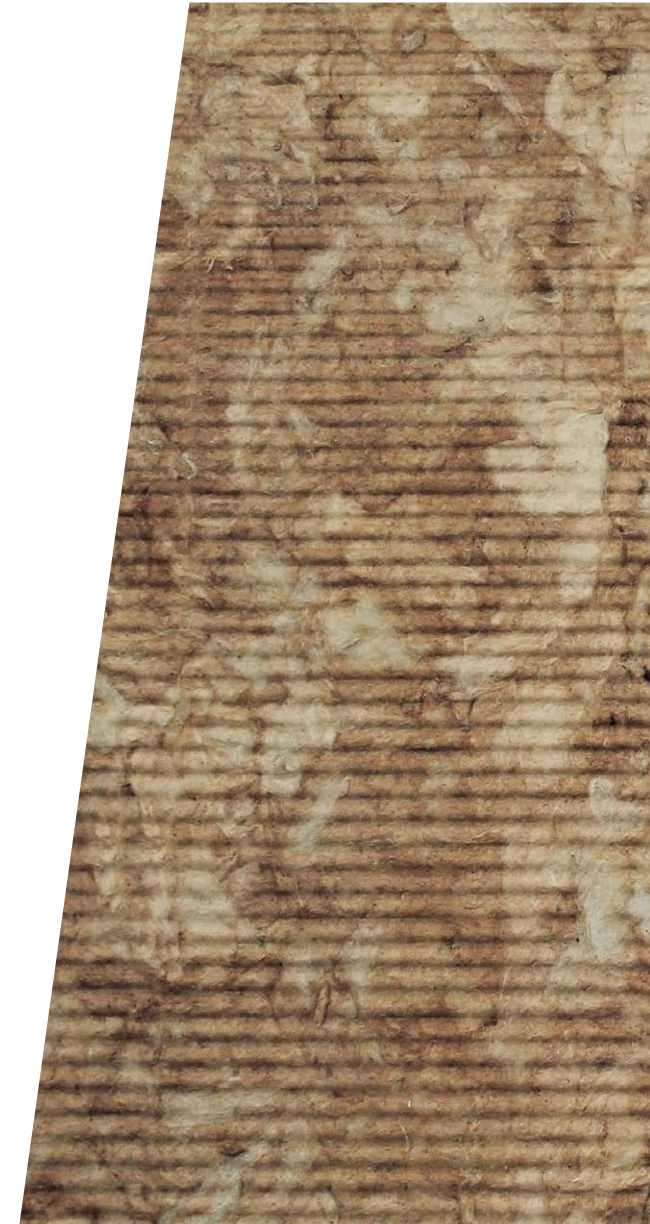

Cutting

CUT NEATLY WITH A SHARP INSULATION SAW/KNIFE

Cut neatly with a fine serrated saw or a large bladed knife.



Gives a factory quality cut and prevents tearing



Use insulation saw or knife



Cut using bladed saw



AREAS THAT CANNOT ACCEPT A FULL SLAB SHOULD BE FILLED WITH A SLAB SECTION

Areas of insulation that do not require a full slab can be filled using a slab section where the section is cut slightly oversize to give a tight fit and fixed at 600mm intervals in the centre of the section.



Slab cut and snug fit



Loose fit for cut slab section

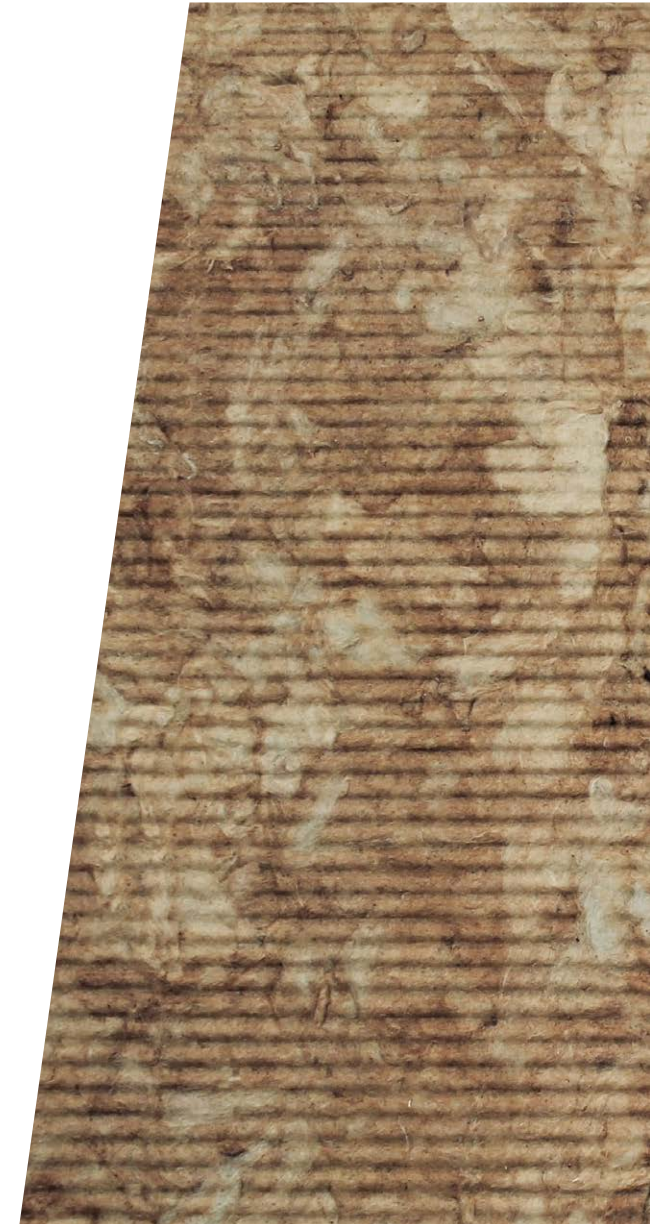
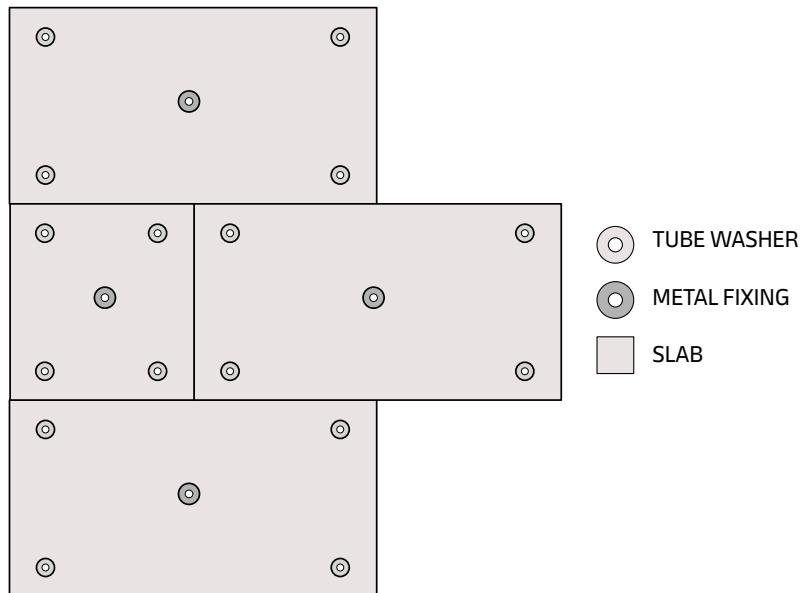

Maintenance

REPAIRS

In the event of small repairs being needed on site, we recommend the replacement of full slabs wherever possible.

✓ Full slab replacement after damage

✗ Small patched repair

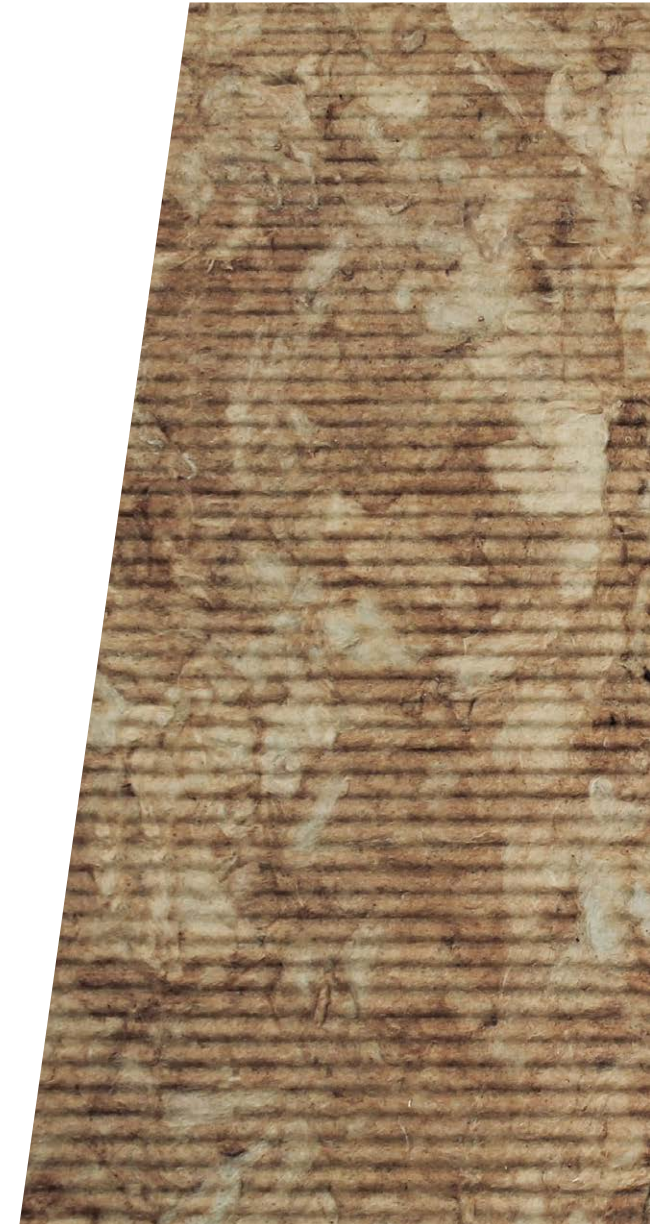
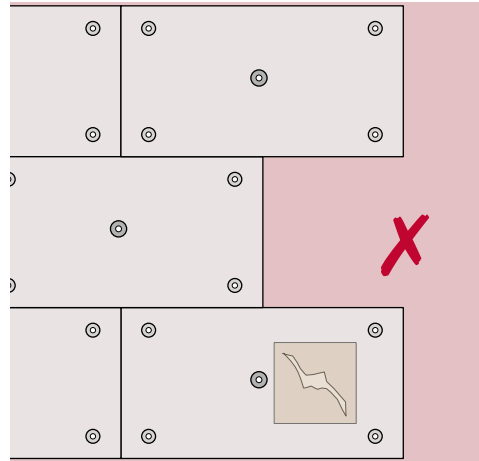
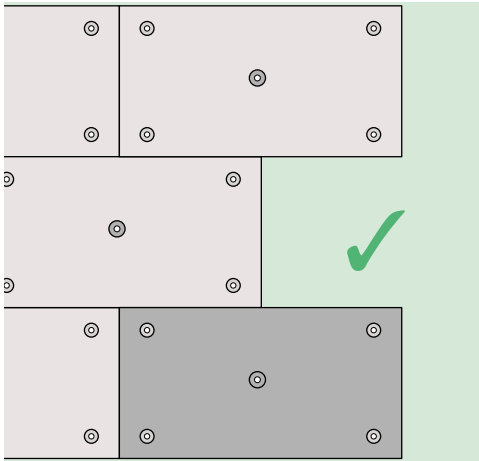

Contacts

Technical Services Team

01744 766 666

technical.uk@knaufinsulation.com

For more information please visit

knauf.com

KNAUFINSULATION



Knauf Insulation Ltd

Stafford Road, St.Helens, Merseyside, WA10 3LZ Customer Service: 01744 766 766

All rights reserved, including those of photomechanical reproduction and storage in electronic media. Extreme caution was observed when putting together and processing the information, text and illustrations in this document. Nevertheless, errors cannot be completely ruled out. The publisher and editors cannot assume legal responsibility or any liability for incorrect information and consequences thereof. The publisher and editors will be grateful for improvement suggestions and details of possible errors pointed out. For the most up-to-date document versions and product information, please always refer to our website.

KINE4295DAT-V0725

Build on us.