



Стенни системи

## METAL Wallcoustic Horizon 1000 / 1100

(METAL W-H 1000 / W-H 1100)

Групирани













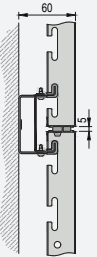
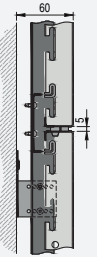





































































- METAL Wallcoustic Horizon 1000 и METAL Wallcoustic Horizon 1100 са системи за стенни облицовки без видим крепеж и бърз монтаж.
- Системата пести пространство със малко монтажно разстояние.
- Панелите могат да бъдат разположени вертикално или хоризонтално.
- METAL Wallcoustic Horizon 1000 с C-профил за стена се монтира хоризонтално, докато METAL Wallcoustic Horizon 1100 с U-профил за стена се монтира вертикално. Големината и ориентацията на панелите определят избора на една или друга система.
- Бързина на монтаж и демонтаж.
- Цялостно решение за стена, което осигурява акустична функция в помещенията.
- Предлагат се допълнителни опции за дизайн, които са част от серия Vario Design.
- Акустични и дизайнерски решения за пазарни сегменти като офис, образование и транспорт.





# METAL Wallcoustic Horizon 1000 / 1100

Групирани

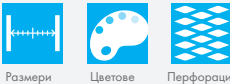
<p><b>Данни за кантовете</b></p> 	<p><b>METAL Wallcoustic Horizon 1000</b></p> 	<p><b>METAL Wallcoustic Horizon 1100</b></p> 																								
<p><b>Система</b></p> 	<p>C-профил за стена</p>	<p>U-профил за стена</p>																								
<p><b>Размери (мм)</b></p> 	<p>Дължина на паното: 600 - 3000 Ширина на паното: 250 - 1000 Макс. площ (m<sup>2</sup>): 3</p>	<p>Дължина на паното: 600 - 3000 Ширина на паното: 250 - 1000 Макс. площ (m<sup>2</sup>): 3</p>																								
<p><b>Материал и перфорации</b></p> 	<p>Галванизирана стомана с полиестерно крайно покритие, 1.0мм</p> <div style="display: flex; justify-content: space-around;"> <div data-bbox="279 745 502 817"> <p>Неперфорирана</p>  </div> <div data-bbox="531 745 754 817"> <p>Стандартна перфорация <b>Rg 2516</b></p>  <p>Ø: 2.5мм Площ на отворите: 16%</p> </div> <div data-bbox="783 745 1007 817"> <p>Микро перфорация <b>Rd 1522</b></p>  <p>Ø: 1.5мм Площ на отворите: 22%</p> </div> </div> <p><b>Други перфорации</b></p> <div style="display: flex; justify-content: space-around;"> <div data-bbox="279 909 422 981"> <p>Rd 1511</p>  </div> <div data-bbox="531 909 675 981"> <p>Rg 1511</p>  </div> <div data-bbox="783 909 927 981"> <p>Rg 3013</p>  </div> </div>																									
<p><b>Цвета</b></p> 	<div style="display: flex; justify-content: space-between;"> <div data-bbox="279 1048 502 1176"> <p>RAL 9010</p>  </div> <div data-bbox="531 981 1189 1234"> <p><b>Цвета Vario Design</b></p> <table border="0"> <tr> <td> Гранит</td> <td> Стомана</td> <td> Зелен мрамор</td> <td> Мед</td> <td> Дъб</td> <td> Месинг</td> <td> Пясъчник</td> <td> Бетон</td> </tr> <tr> <td> RAL 9003</td> <td> RAL 9005</td> <td> RAL 9006</td> <td> RAL 9007</td> <td> RAL 9016</td> <td> Global White</td> <td colspan="2"></td> </tr> </table> </div> <div data-bbox="1201 981 1532 1234"> <p><b>Дървесен ефект</b></p> <table border="0"> <tr> <td> Ясен</td> <td> Естествен бамбук</td> <td> Бамбук карамел</td> <td> Клен</td> </tr> <tr> <td> Дъб</td> <td> Американска череша</td> <td> Американски орех</td> <td></td> </tr> </table> </div> </div>		 Гранит	 Стомана	 Зелен мрамор	 Мед	 Дъб	 Месинг	 Пясъчник	 Бетон	 RAL 9003	 RAL 9005	 RAL 9006	 RAL 9007	 RAL 9016	 Global White			 Ясен	 Естествен бамбук	 Бамбук карамел	 Клен	 Дъб	 Американска череша	 Американски орех	
 Гранит	 Стомана	 Зелен мрамор	 Мед	 Дъб	 Месинг	 Пясъчник	 Бетон																			
 RAL 9003	 RAL 9005	 RAL 9006	 RAL 9007	 RAL 9016	 Global White																					
 Ясен	 Естествен бамбук	 Бамбук карамел	 Клен																							
 Дъб	 Американска череша	 Американски орех																								
<p><b>Тегло</b></p> 	<p><b>Неперфорирана</b> 8.6 - 11.3 kg/m<sup>2</sup></p>	<p><b>Rg 2516</b> 7.3 - 10.0 kg/m<sup>2</sup></p>	<p><b>Rd 1522</b> 6.7 - 9.6 kg/m<sup>2</sup></p> <p><i>Теглото варира в зависимост от детайла на канта и акустичната вложка.</i></p>																							
<p><b>Светлоотражение</b></p> 	<p><b>Неперфорирана</b> 85%</p>	<p><b>Rg 2516</b> 70%</p>	<p><b>Rd 1522</b> 65%</p> <p><i>Стойности валидни само за RAL 9010.</i></p>																							
<p><b>Влагуустойчивост</b></p> 	<p><b>90% RH</b></p>																									
<p><b>Почистване</b></p>	 <p>(само неперфорирани)</p>																									
<p><b>Дълговечност</b></p>	 <p>≈14%    EN ISO 14021    GreenStar    Silver*</p> <p><i>*Стойности валидни само за RAL 9010.</i></p>																									
<p><b>Опции за дизайн</b></p>	 <p>Размери    Цветове    Перфорация</p>																									

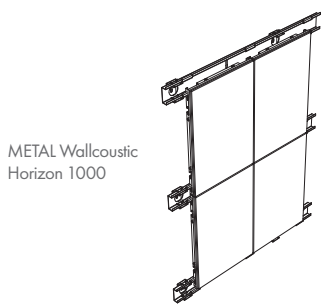

METAL Wallcoustic Horizon 1000

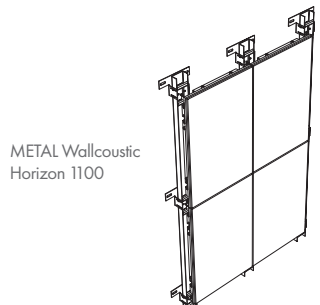

METAL Wallcoustic Horizon 1100

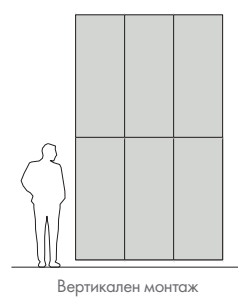

Вертикален монтаж

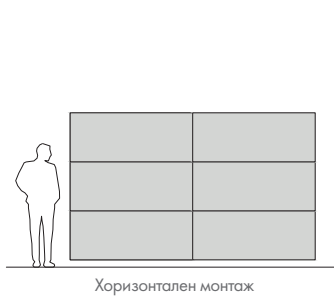

Хоризонтален монтаж

[Предишна страница] METAL Wallcoustic Horizon 1100 (Международно летище Дубай, Дубай, ОАЕ, © Verpe Raso)

Опциите с тази икона са налични в серия **Vario Design**. Някои комбинации от цветове и/или перфорации не са налични за всеки продукт. Продуктите могат да варират в различните страни. Моля свържете се с Вашия регионален представител. Допълнителна информация и правна рамка можете да намерите на нашия уебсайт. [knaufceilingsolutions.com](http://knaufceilingsolutions.com)