

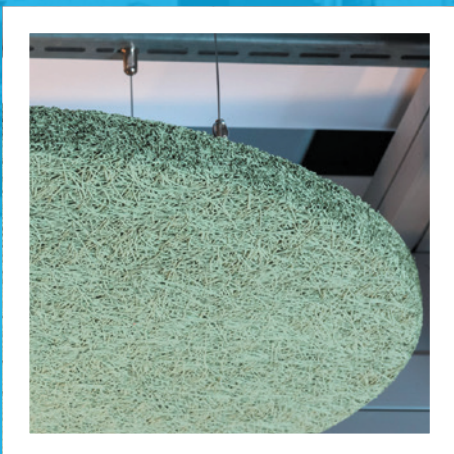

Deckensegel

HERADESIGN® Sonic Element















Einzelement / Gruppierte Elemente



- HERADESIGN® Sonic Element ist ein dekoratives Akustikdeckensegel aus Holzwolle, das unbegrenzte Gestaltungsmöglichkeiten bietet
- HERADESIGN® Sonic Element ist mit einer HERADESIGN® Superfine Oberfläche erhältlich
- Wird als vormontierter Bausatz geliefert und ist somit schnell und einfach zu montieren
- Erhältlich in Vario Design sowie in RAL- und NCS-Farben
- Deckensegel-Bausatz inklusive Unterkonstruktion und Abhänger
- Schnelle und einfache Montage durch hohen Vorfertigungsgrad

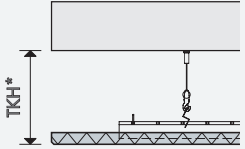

Deckensegel
HERADESIGN® Sonic Element
 Einzelement / Gruppierete Elemente

Oberflächen		HERADESIGN® Superfine 																																															
Dicke (mm)		35																																															
Abmessungen (mm)		HERADESIGN® Sonic Element Circle: Ø 1200mm HERADESIGN® Sonic Element Square: 1200 x 1200mm HERADESIGN® Sonic Element Hexagon: 1200 x 1040mm																																															
System		Deckensegel-Bausatz enthält Unterkonstruktion und Abhänger Einfache und schnelle Installation mit vier Drahtseilabhänger Seillänge 1000 mm Option U-Profil-Gruppierungssystem																																															
Gewicht		HERADESIGN® Sonic Element Circle: 19,4 kg/Stk. HERADESIGN® Sonic Element Square: 24,8 kg/Stk. HERADESIGN® Sonic Element Hexagon: 16,2 kg/Stk.																																															
Farben		Standard Farben	vo Vario Design Farben																																														
		 Weiss Ähnlich RAL 9010	 Beige Naturton 13																																														
		 <ul style="list-style-type: none"> • Andere Farben aus den gängigen RAL- und NCS-Farbsystemen sind erhältlich. • Aufgrund der rauen Faser- und Plattenoberfläche können Abweichungen in Farbe und Aussehen auftreten. 																																															
Schallabsorption		<table border="1"> <thead> <tr> <th rowspan="2">Deckensegel [mm]</th> <th rowspan="2">TKH [mm]</th> <th colspan="6">Äquivalente Absorptionsfläche Aobj [m²]</th> </tr> <tr> <th colspan="6">Frequenz [Hz], α_n</th> </tr> <tr> <th></th> <th></th> <th>125</th> <th>250</th> <th>500</th> <th>1000</th> <th>2000</th> <th>4000</th> </tr> </thead> <tbody> <tr> <td>HERADESIGN® Sonic Element Circle</td> <td>200</td> <td>0,20</td> <td>0,60</td> <td>0,90</td> <td>0,70</td> <td>1,10</td> <td>1,40</td> </tr> <tr> <td>HERADESIGN® Sonic Element Square</td> <td>200</td> <td>0,10</td> <td>0,70</td> <td>1,10</td> <td>0,90</td> <td>1,40</td> <td>1,70</td> </tr> <tr> <td>HERADESIGN® Sonic Element Hexagon</td> <td>200</td> <td>0,10</td> <td>0,50</td> <td>0,70</td> <td>0,70</td> <td>1,00</td> <td>1,20</td> </tr> </tbody> </table>  <p>* Totale Konstruktionshöhe</p>		Deckensegel [mm]	TKH [mm]	Äquivalente Absorptionsfläche Aobj [m²]						Frequenz [Hz], α _n								125	250	500	1000	2000	4000	HERADESIGN® Sonic Element Circle	200	0,20	0,60	0,90	0,70	1,10	1,40	HERADESIGN® Sonic Element Square	200	0,10	0,70	1,10	0,90	1,40	1,70	HERADESIGN® Sonic Element Hexagon	200	0,10	0,50	0,70	0,70	1,00	1,20
Deckensegel [mm]	TKH [mm]	Äquivalente Absorptionsfläche Aobj [m²]																																															
		Frequenz [Hz], α _n																																															
		125	250	500	1000	2000	4000																																										
HERADESIGN® Sonic Element Circle	200	0,20	0,60	0,90	0,70	1,10	1,40																																										
HERADESIGN® Sonic Element Square	200	0,10	0,70	1,10	0,90	1,40	1,70																																										
HERADESIGN® Sonic Element Hexagon	200	0,10	0,50	0,70	0,70	1,00	1,20																																										
Brandverhalten		Euroklasse B-s1,d0 gemäß EN 13501-1																																															
Feuchtigkeitsbeständigkeit		Nicht geeignet für Hallenbäder, Tiefgaragen und Außenbereiche																																															
Reinigung																																																	
Nachhaltigkeit																																																	

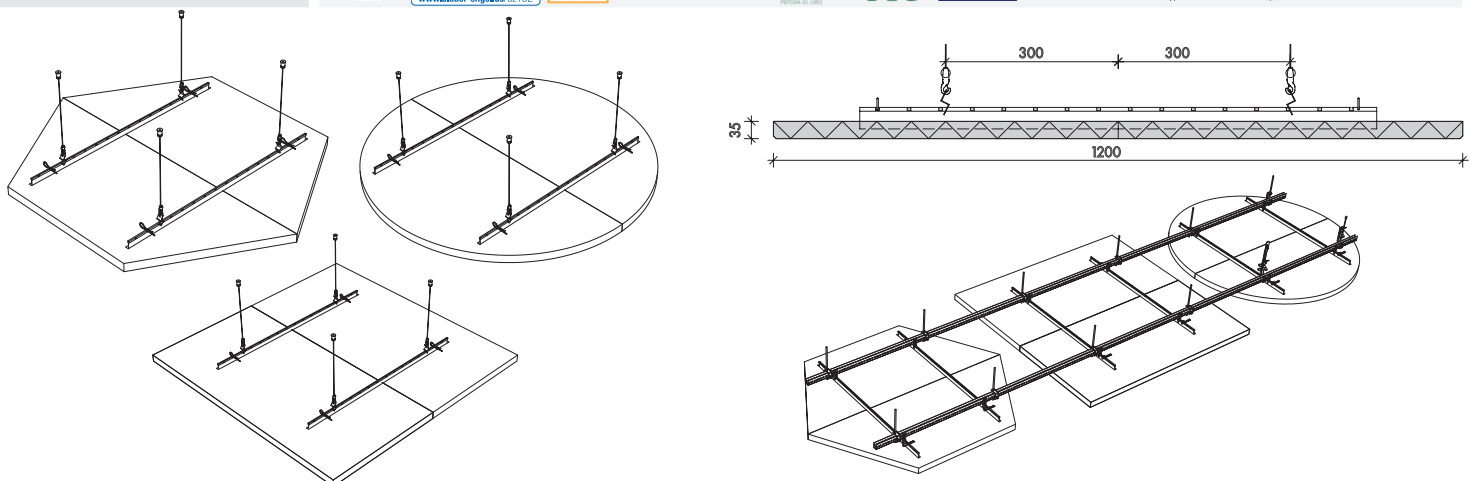

Vorherige Seite HERADESIGN® Sonic Element (© Knauf Ceiling Solutions)

vo Optionen mit diesem Symbol sind in unserem **Vario Design** Sortiment erhältlich. Einige Farbkombinationen und/oder Perforationen sind nicht für jedes Produkt verfügbar. Die Produkte können von Land zu Land variieren. Bitte wenden Sie sich an Ihren örtlichen Vertriebsmitarbeiter. Für weitere Informationen und rechtliche Hinweise besuchen Sie bitte unsere Website knaufceilingsolutions.com