

U-Profile + H-Profile 35

Suspension system for concealed Hook-On solutions

Key features

- For rectangular panel layouts
- Installed on the modular U-Profile primary grid system, with unique plug-in clip for quick and accurate installation
- Full range of accessories with multiple suspension options
- Clip for secure installations

Application areas

- From small service rooms to large commercial office buildings and major transportation terminals

Systems

- METAL R-H 215 / MESH R-H 215 / MESH R-H 215 MT

U-Profile

& Accessories

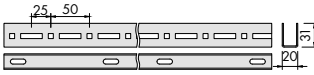

Item reference	Description	Dimensions (mm)	Material	Colour	Unit		Weight/ Unit kg
					pcs	lm	
M300100	U-Profile	3746 x 20 x 31	Galvanised steel	-	10	37.5	28.9
M300119	Splice connector for U-Profile	95 x 23 x 18	Galvanised steel	-	100	-	5.3
M300120	Plug-in clip for U-Profile	20 x 21 x 6	Spring steel	-	100	-	0.2
M300140	Wall anchor	90 x 35 x 25	Galvanised steel	-	100	-	3.7
M311303	Hexagonal bolt M6 x 16 mm	M6 x 16	Galvanised steel	-	500	-	2.5
M311103	Hexagonal nut M6	M6 x 5	Galvanised steel	-	1000	-	3.0
M311305	Washer M6 18 x 1.6 mm	Ø18 x 1.6	Galvanised steel	-	200	-	0.6
M300121	Clamping bracket for U-Profile	43 x 37 x 20	Spring steel	-	100	-	2.3
M300366	Hanger for U-Profile	85 x 33 x 19	Galvanised steel	-	100	-	3.8
M300166	Combi-Nonius hanger for U-Profile	156 x 36 x 19	Galvanised steel	-	100	-	6.6

H-Profile 35 & Accessories

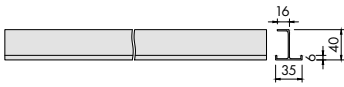





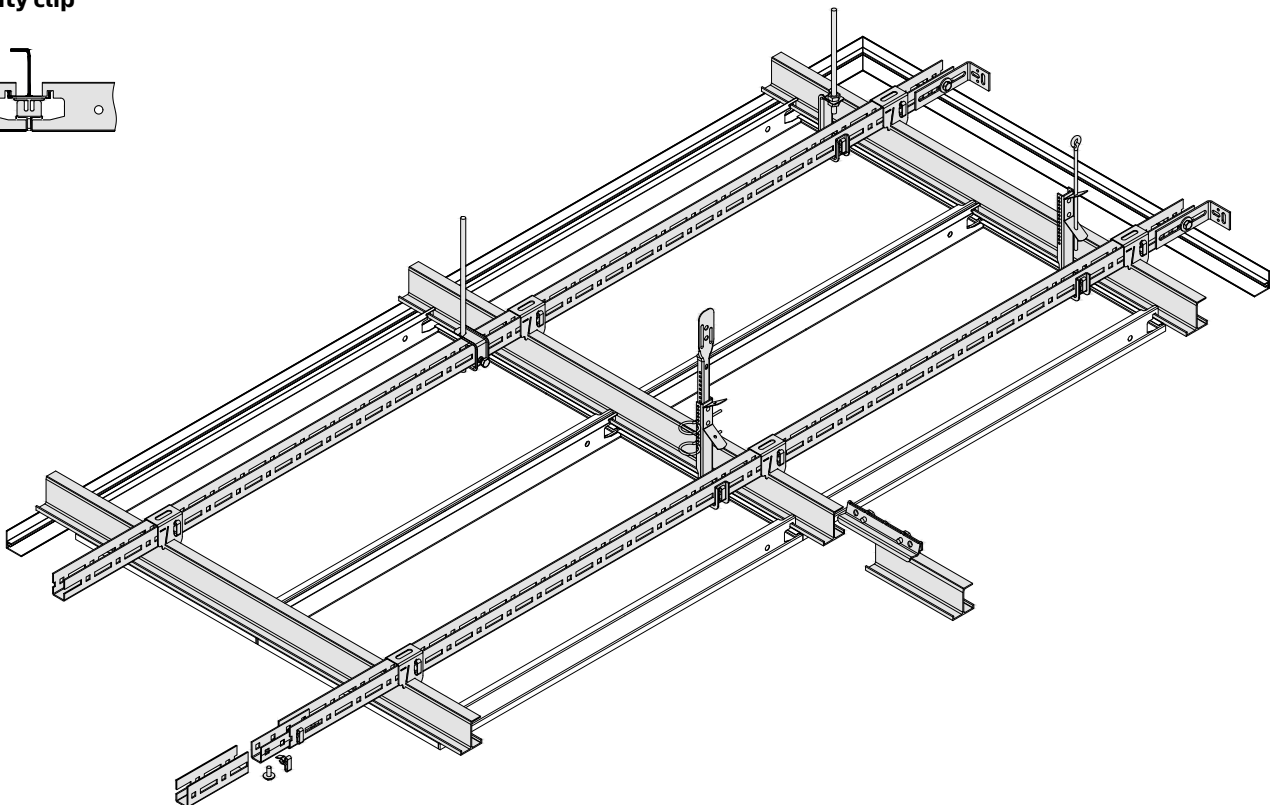
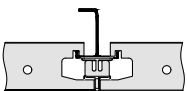

Item reference	Description	Dimensions (mm)	Material	Colour	Unit		Weight/Unit kg
					pcs	lm	
M311400	H-Profile 35	4000 x 35 x 40	Aluminium	-	10	40	16.9
M300343	Splice connector for H-Profile 35	120 x 22 x 20	Galvanised steel	-	100	-	9.5
M300307	Hanger for H-Profile 35	62 x 40 x 47	Galvanised steel	-	100	-	3.6
M300235	Security clip (for METAL R-H 215)	42 x 16 x 22	Spring steel	-	100	-	0.7
M311034	Extraction tool (M300235 security clip)	228 x 59 x 20	Stainless steel / plastic	-	1	-	0.1

System Drawing

Security clip



U-Profile + H-Profile 35

Characteristics	Detailed information	
Fire reaction		Euroclass A1 as per EN 13501-1
Indoor air quality		 A+
Cleanability	  	
Sustainability		up to 25%

All measurements in millimetres. All sizes are nominal.
Cross Tee alignment is achieved by locating the tees to the left-hand side of the adjoining section.

Products may vary from country to country. Please contact your local sales representative.
For further information and legal notice, please visit our website.