













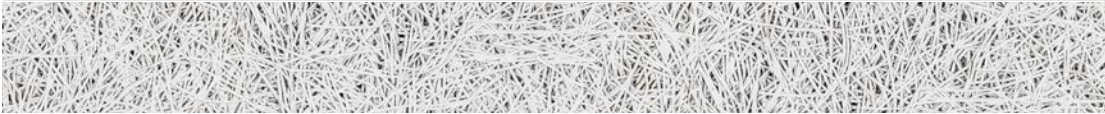











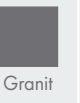
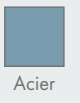
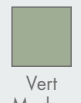

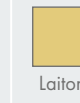
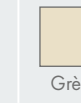
**KNAUF**CEILING  
Solutions

## FICHE TECHNIQUE HERADESIGN® Wallcoustic Element



L'absorbeur mural HERADESIGN® est un panneau acoustique mural en laine de bois liée à la magnésie, lié à un doublage acoustique de 50 mm ou 100 mm.

- Disponible en quatre tailles différentes avec la surface HERADESIGN® Superfine
- Livré en kit, pour une installation simple et rapide

|                                     |  |  |   |   |   |   |  |   |   |   |   |
|-------------------------------------|--|--|---|---|---|---|--|---|---|---|---|
|                                     |  | HERADESIGN® Superfine  |   |   |   |   |  |   |   |   |   |
| <b>Surface</b>                      |   |    |   |   |   |   |  |   |   |   |   |
| <b>Épaisseur</b>                    |   | 25 mm  |   |   |   |   |  |   |   |   |   |
| <b>Dimensions standard et poids</b> | <br> | <b>HERADESIGN® Wallcoustic Element</b><br>Format (mm)<br>L x l x H   | <b>Doubleure en laine minérale (mm)</b>   |   |   |   | <b>Poids (kg/Element)</b>  |   |   |   |   |
|                                     |  | 1200 x 600 x 125   | 100   |   |   |   | 18,30  |   |   |   |   |
|                                     |  | 1200 x 600 x 75  | 50  |   |   |   | 15,90  |   |   |   |   |
|                                     |  | 600 x 600 x 125  | 100   |   |   |   | 10,50  |   |   |   |   |
|                                     |  | 600 x 600 x 75   | 50  |   |   |   | 8,40   |   |   |   |   |
| <b>Système</b>                      |   | L'absorbeur mural est livré en une seule pièce, prêt à être installé, et peut être rapidement monté sur un support vertical dans n'importe quelle position à l'aide du cadre en bois inclus.   |   |   |   |   |  |   |   |   |   |
| <b>Réaction au feu</b>              |   | Euroclass <b>B-s1,d0</b> en accord avec EN 13501-1   |   |   |   |   |  |   |   |   |   |
| <b>Absorption acoustique</b>        |   | HERADESIGN® Wallcoustic Element<br>Format (mm)<br>L x l x H  | Revêtement acoustique HERADESIGN®<br>Épaisseur (mm)   (kg/m³)                       |   | Surface d'absorption équivalente A <sub>obj</sub> [m²]<br>Fréquences [Hz]           |   |  |   |   |   |   |
|                                     |  |  |   |   | 125   | 250   | 500  | 1000  | 2000  | 4000  |   |
|                                     |  | 1200 x 600 x 125   | 100   | 50  | 0,60  | 1,30  | 1,40   | 1,20  | 1,10  | 1,10  |   |
|                                     |  | 1200 x 600 x 75  | 50  | 50  | 0,20  | 0,80  | 1,10   | 0,90  | 1,00  | 0,90  |   |
|                                     |  | 600 x 600 x 125  | 100   | 50  | 0,30  | 0,70  | 0,80   | 0,70  | 0,60  | 0,60  |   |
|                                     |  | 600 x 600 x 75   | 50  | 50  | 0,10  | 0,40  | 0,60   | 0,50  | 0,50  |   |   |
| <b>Résistance à l'humidité</b>      |   | Ne convient pas à une utilisation dans les piscines intérieures, les garages souterrains et les espaces extérieurs.  |   |   |   |   |  |   |   |   |   |
| <b>Facilité de nettoyage</b>        |   |  |   |   |   |   |  |   |   |   |   |
| <b>Couleurs</b>                     |   | <b>Couleurs standard</b>   |   | <b>vd VD couleurs Vario Design</b>  |   |   |  |   |   |   |   |
|                                     |  |   |  |  |  |  |  |  |  |  |  |
|                                     |  | Blanc<br>Similaire à RAL 9010  | Beige<br>Ton naturel 13   | Granit  | Acier   | Vert<br>Marbre  | Cuivre   | Chêne   | Laiton  | Grès  | Béton   |
|                                     |  | <ul style="list-style-type: none"> <li>• Autres couleurs RAL et NCS disponibles.</li> <li>• Des différences de teinte peuvent se produire en raison de la surface rugueuse des fibres et des panneaux.</li> </ul>  |   |   |   |   |  |   |   |   |   |
| <b>Durabilité</b>                   |  |          |   |   |   |   |  |   |   |   |   |

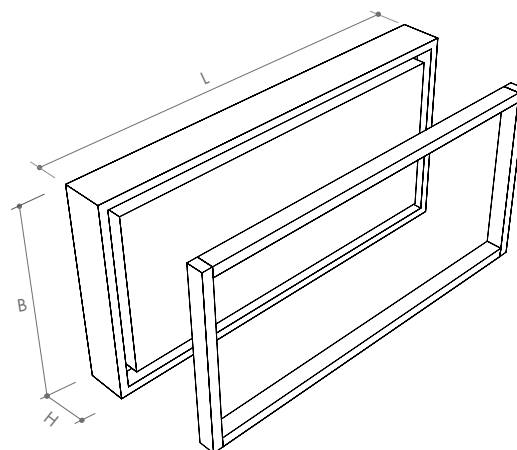

Les produits peuvent varier suivant les pays. Veuillez contacter votre représentant commercial local.  
Pour obtenir plus d'informations et connaître les mentions légales, veuillez consulter notre site Internet.