

# Colors & Finishes

Knauf Ceiling Solutions standard colour for post-coated METAL RAL 9010 (Pure White) and additional Vario Design colours and wood effects.

## Colours



## Wood Effects



## METAL BioGuard

METAL BioGuard coating is designed for applications where suspended ceilings are required, and hygiene and cleanliness are of the utmost importance. METAL BioGuard is more effective in the control of bacteria than a standard powder coating because it prevents the settlement of bacteria on the surface of the product. METAL BioGuard gives good cleanability and resistance to disinfectants as well as cleanroom performance. For more information, please get in touch with us.

## Perforations

The predefined post-coated METAL standard and Vario Design offer is available in the most popular perforations.

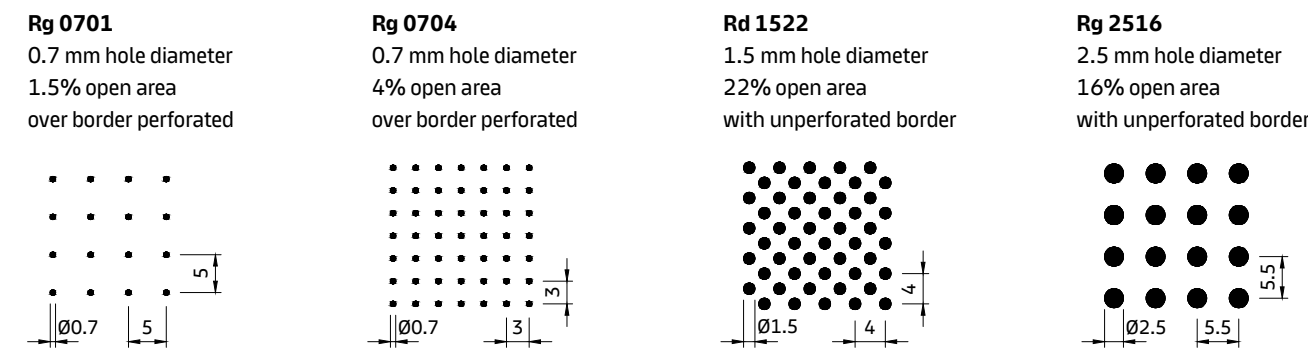

Perforated products are delivered with a standard black acoustic fleece VLSRX. For a higher acoustical performance, Premium infills are offered. Further acoustic infill options on request.

Knauf Ceiling Solutions extensive Vario Design range of more than 40 perforations gives a wide choice of aesthetic options: large apertures for specialised uses such as airflow or loudspeakers to slotted perforations for a more linear appearance.

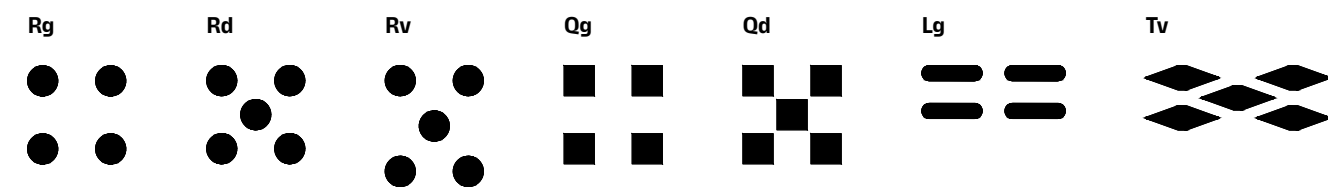

The availability of the dimensions, colours and perforations shown here vary depending on the system / product selected.

# Shapes & Systems

**Exposed Grid**  
Exposed ceiling systems provide a modular aesthetic and are available in a variety of edge details.

**Concealed Grid**  
Concealed ceiling solutions create a continuous, monolithic look by concealing all of the grid system.

**Grille - Open Cell**  
Open cell metal tiles mask the plenum and provide 100% accessibility to lighting, ventilation and sprinklers with an homogeneous appearance. a variety of edge details.

**Floating Ceilings - Canopies**  
Open up an almost endless range of dramatic design possibilities with canopies that can be suspended from any soffit.

**Linear & Baffle Solutions**  
Discover the potential of baffle and linear solutions to create sleek and clean designs combined with functional excellence. Craft distinctive and memorable interiors with our wide array of materials, finishes, colours and configurations.

**Free Span Corridor Solutions**  
With easy installation and access to services, wall-to-wall corridor solutions require functionality to handle high traffic and design flexibility to connect key spaces seamlessly.

**Wall Solutions**  
Walls solutions come in a variety of designs to provide a stunning visual durable enough for high-impact or high traffic areas. Coordinate with ceilings and other interior finishes to create signature spaces.



# METAL Overview

**Build on us.**

# METAL Selector

	Design Layout				Material	Vario Design Options On Request										Features & Performances													
	Exposed Grid	Concealed Grid	Grille - Open cell	Floating Ceilings - Canopies		Linear & Baffle Solutions	Free Span Corridor Solutions	Wall Solutions	Post-coated galvanised steel	Pre-coated galvanised steel	Pre-coated aluminium	Dimensions	Shapes	Post-coated aluminium	Perforations	RAL & NCS colours	BioGuard finish	Wood Effect finish	Acoustic infills	Cut-outs	Grid alternatives	Acoustics	Secure function	Swing-down function	Clean room	Seismic	Impact resistance	Suitable for chilled ceilings	Exterior
METAL Board	■																												
METAL MicroLook 8	■																												
METAL Tegular 2	■																												
METAL Tegular 8	■																												
METAL Axal Vector	■																												
METAL R-L 201	■																												
METAL B-L 302	■																												
METAL B-H 300	■																												
METAL K-H 400	■																												
METAL Q-Clip		■																											
METAL Q-Clip F		■																											
METAL R-Clip		■																											
METAL T-Clip F *		■																											
METAL R-H 200		■																											
METAL Q-H 100 F		■																											
METAL R-H 215		■																											
METAL R-H 220 **		■																											
METAL Q-H 120 F **		■																											
METAL Grille Cellio			■																										
METAL Sonic Element				■																									
METAL Sky Element Clip					■																								
METAL Sky Element Hook						■																							
METAL Baffle Element							■																						
METAL Linear Lite								■																					
METAL Linear Blade									■																				
METAL Linear Stripe										■																			
METAL F-L 601											■																		
METAL F-Clip												■																	
METAL F-H 600													■																
METAL F-H 600 Swing														■															
METAL Wallcoustic Element																													
METAL Wallcoustic Horizon 1000																													
METAL Wallcoustic Horizon 1100																													

## Cut-outs

Factory made cut-outs for service integrations

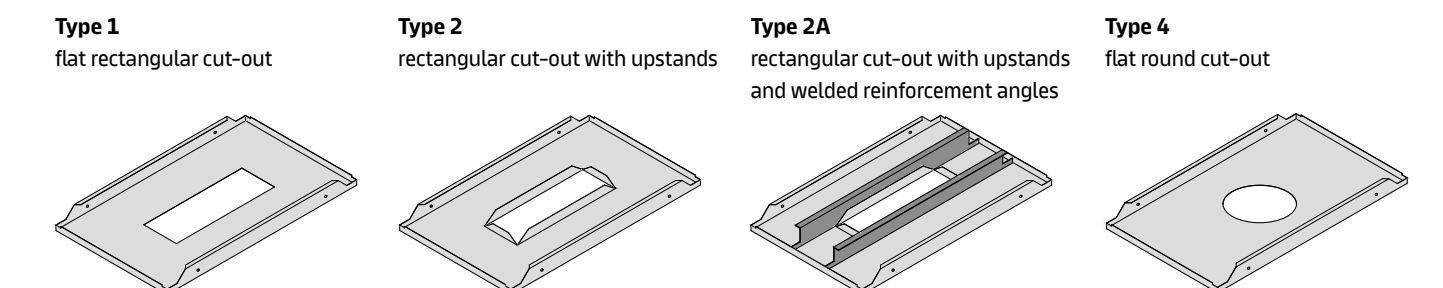

The availability of the cut-out type and dimensions vary depending on the system / product selected.

Knauf Ceilings Holding GmbH  
Am Bahnhof 7  
94346 Iphofen, Germany  
Phone: +49 9323 31-0  
E-Mail: zentrale@knauf.com  
www.knauf.com

Commercial Register: District court, Würzburg  
Registration No.: HRA 6031  
VAT No. pursuant to § 27a of the German VAT Act (Umsatzsteuergesetz): DE317846056  
Board of Directors: Lars Klodwig, Karl Wenig, Daniel Wolf

# METAL System Overview

## Exposed Grid

■ **METAL Board**  
Lay-in system: 24 mm T-grid, butt-cut (System C)  
(optional 15 mm T-grid, butt-cut)

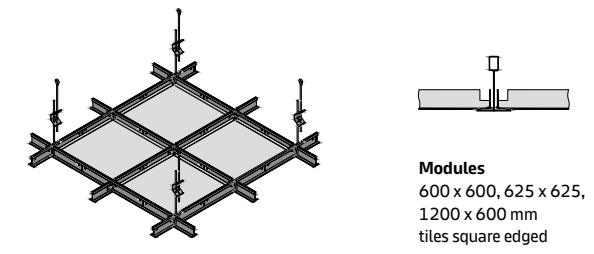

■ **METAL Axial Vector**  
Lay-in semi-concealed system: 24 mm T-grid (System C)

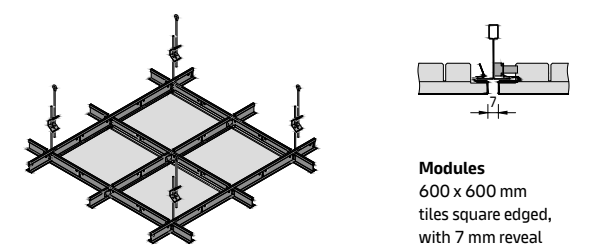

■ **METAL MicroLook 8**  
Lay-in system: 15 mm T-grid (System C)

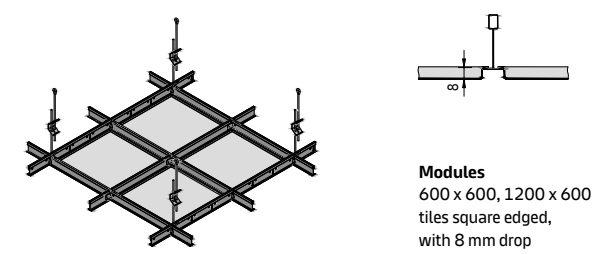

■ **METAL Tegular 2**  
Lay-in system: 24 mm T-grid, butt-cut (System C)

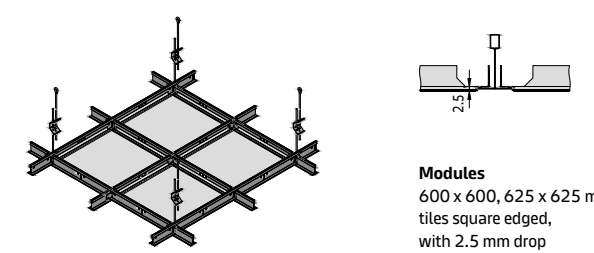

■ **METAL Tegular 8**  
Lay-in system: 24 mm T-grid (System C)

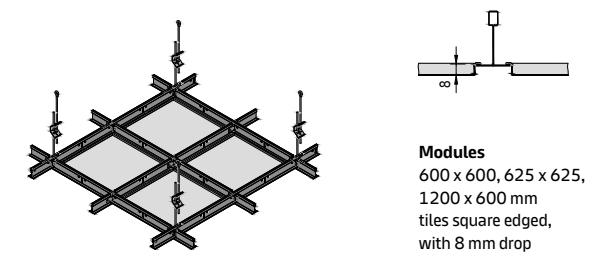

■ **METAL R-L 201**  
Lay-in linear grid system: U-Profile + L-Profile (38 mm)

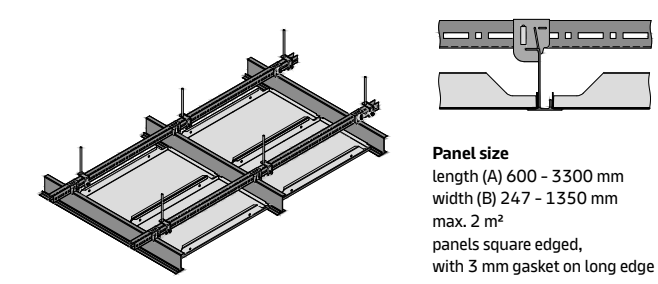

■ **METAL B-L 302**  
Lay-in linear grid system: U-Profile + Bandrastrer (100 mm)

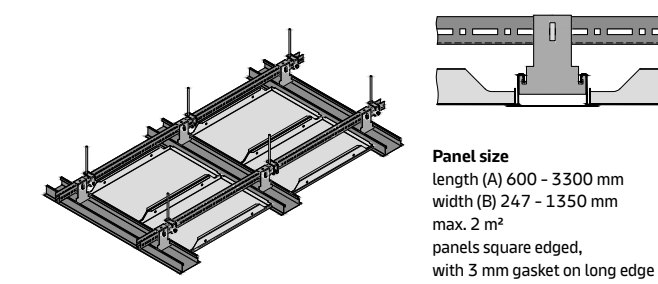

■ **METAL B-H 300**  
Hook-on linear grid system: U-Profile + C-Profile (100 mm),  
further options on request

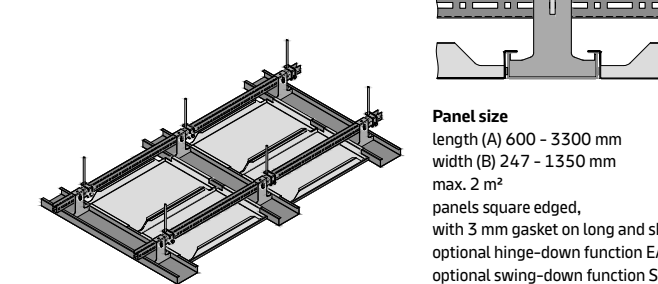

■ **METAL K-H 400**  
Hook-on tartan grid system:  
Crossing-box & C-Profile (100 mm),  
further options on request

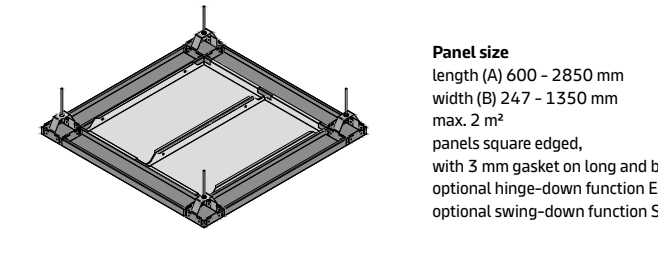

## Concealed Grid

■ **METAL Q-Clip**  
Clip-in system:  
U-Profile + DP12 A-Bar

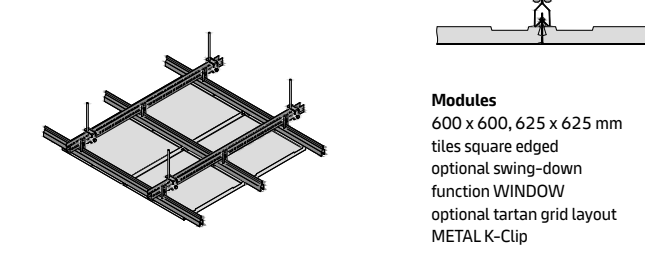

■ **METAL Q-Clip F**  
Clip-in system:  
U-Profile + DP12 A-Bar

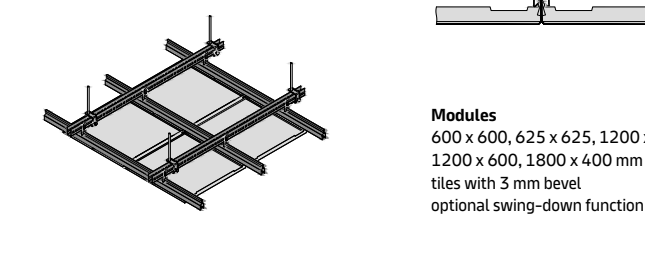

■ **METAL R-Clip**  
Clip-in system:  
U-Profile + DP12 A-Bar

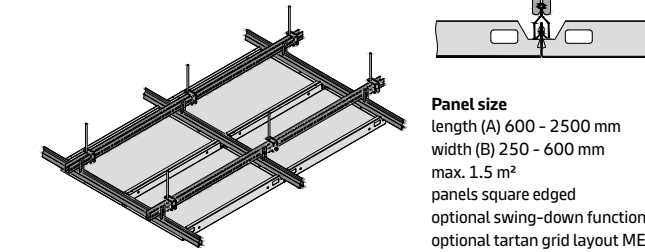

■ **METAL T-Clip F**  
Clip-in system: C-Channel + Spring T  
(optional U-Profile + Spring T) for UK market

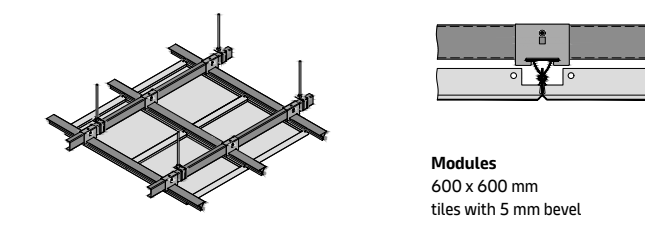

■ **METAL R-H 200**  
Hook-on system: U-Profile + J-Bar

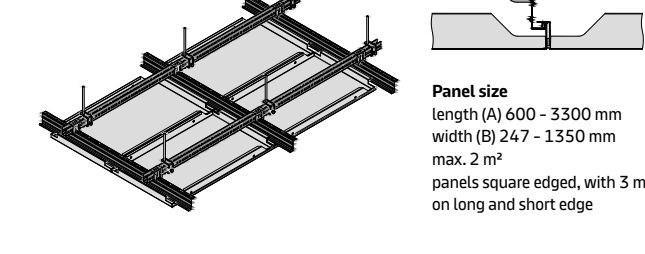

■ **METAL Q-H 100 F**  
Hook-on system: U-Profile + J-Bar

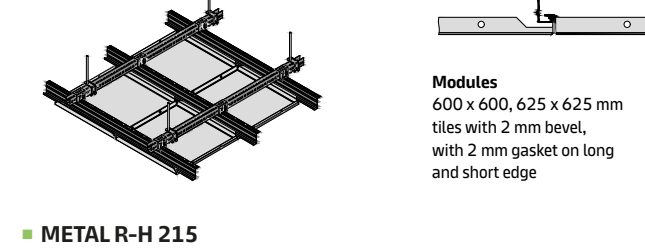

■ **METAL R-H 215**  
Hook-on system:  
U-Profile + H-Profile (35 mm)

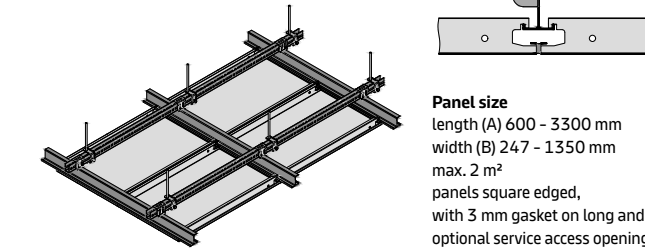

■ **METAL R-H 220**  
Hook-on system: U-Profile + H-Profile  
(28 mm) for Swiss market

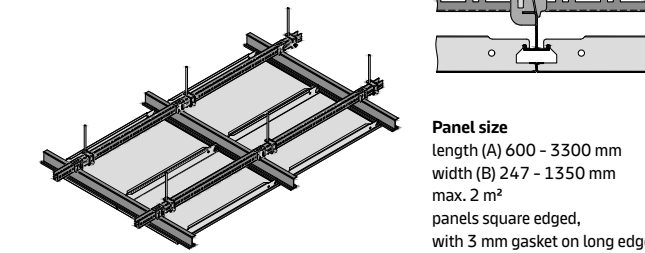

■ **METAL Q-H 120 F**  
Hook-on system: U-Profile + H-Profile (28 mm) for Swiss market

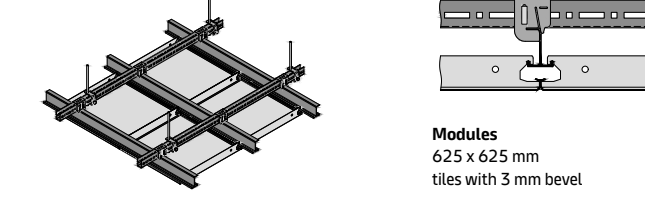

## Grille - Open Cell

■ **METAL Grille Cellio**  
Lay-in system: 15 mm T-grid, butt-cut (System C)

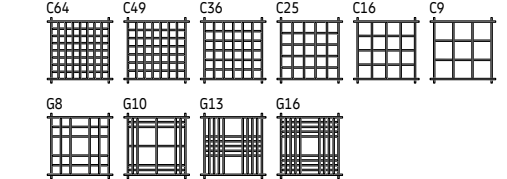
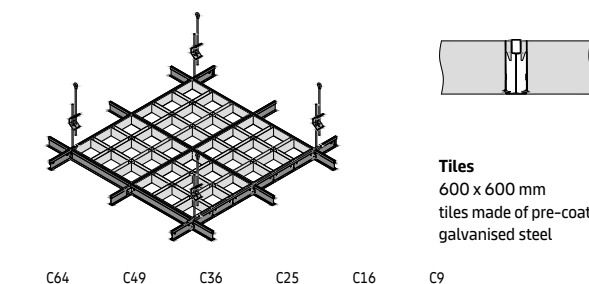

## Floating Ceilings - Canopies

■ **METAL Sonic Element**  
Direct suspended by hanging wires

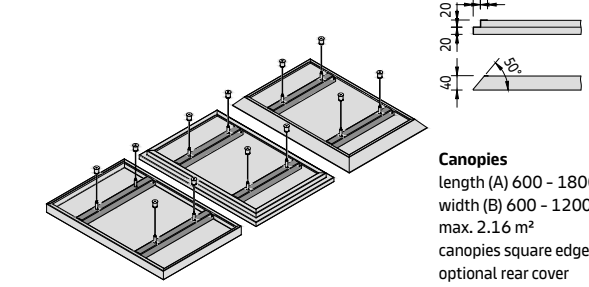

■ **METAL Sky Element Clip**  
Clip-in multipanel solution: U-Profile + DP12 A-Bar

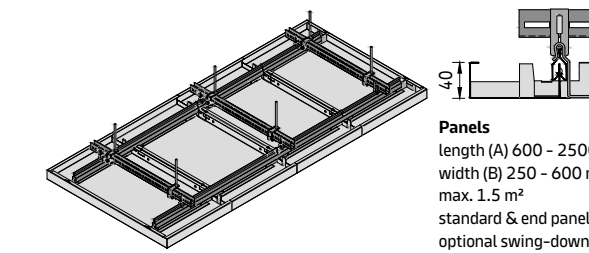

■ **METAL Sky Element Hook**  
Hook-on multipanel solution: U-Profile cross-connected

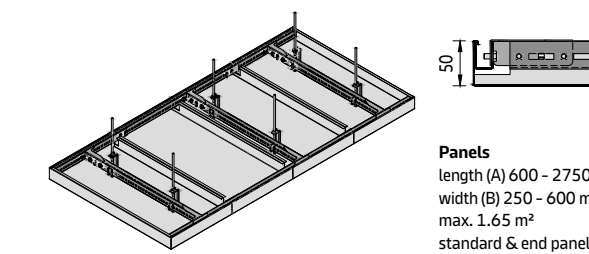

## Linear & Baffle Solutions

■ **METAL Baffle Element**  
Hook-on system: U-Profile + hanger  
(optional single suspended by hanging wires)

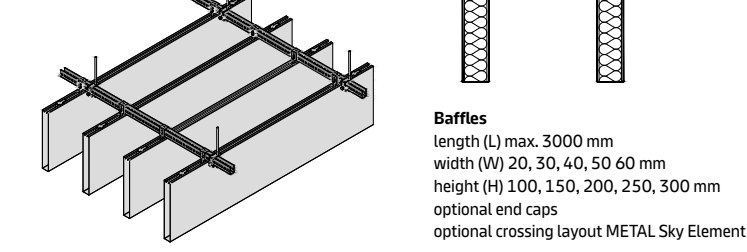

■ **METAL Linear Lite**  
Linear baffle solution: Carrier

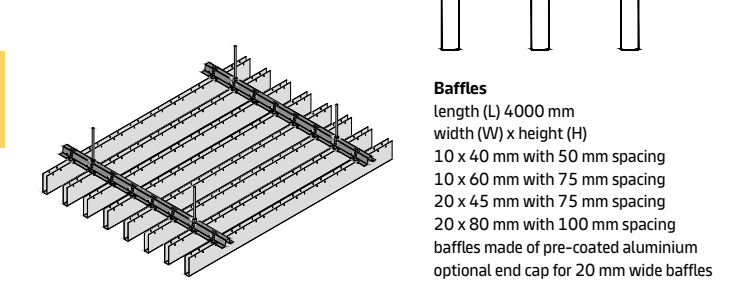

■ **METAL Linear Blade**  
Linear blade solution: Carrier

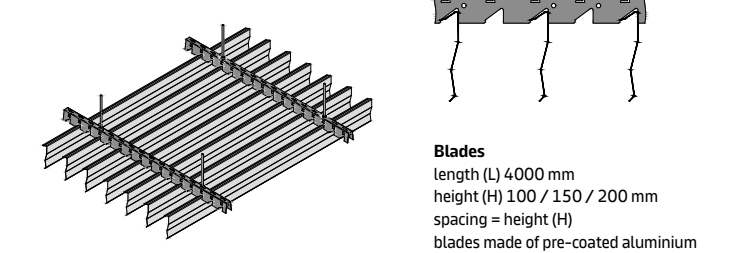

■ **METAL Linear Stripe**  
Linear stripe solution: Carrier

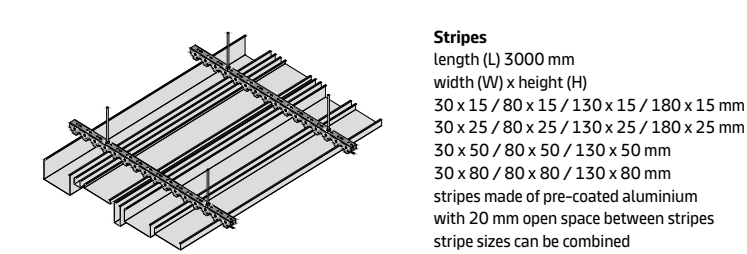

## Free Span Corridor Solutions

■ **METAL F-L 601**  
Lay-in corridor solution:  
Perimeter trim

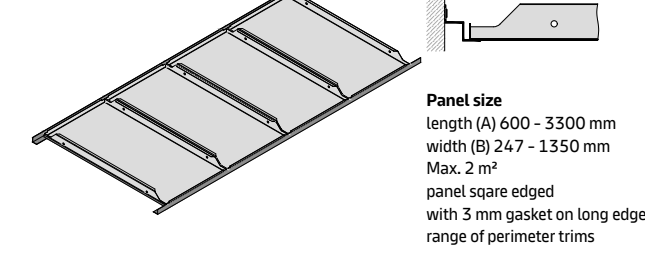

■ **METAL F-Clip**  
Clip-in corridor solution:  
Wall bracket + half DP12 A-Bar  
(optional DP12 A-Bar)

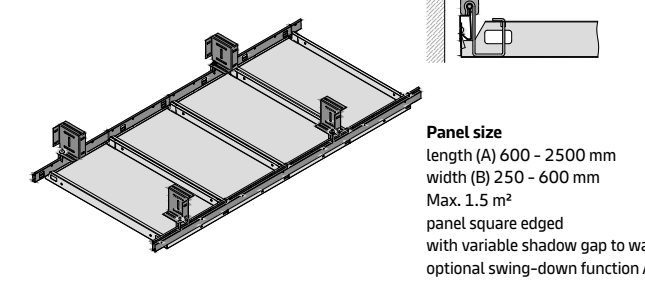

■ **METAL F-H 600**  
Hook-on corridor solution:  
Wall bracket + J-Bar

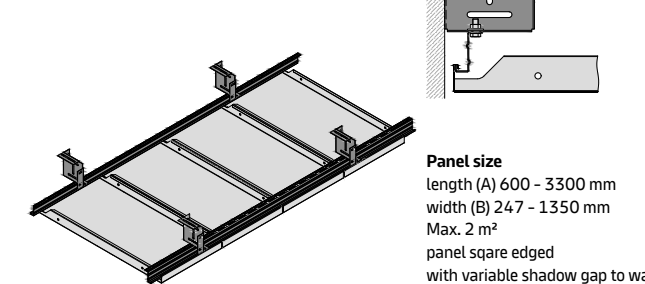

■ **METAL F-H 600 Swing**  
Hook-on corridor solution:  
Wall bracket + G-Profile (25 mm)

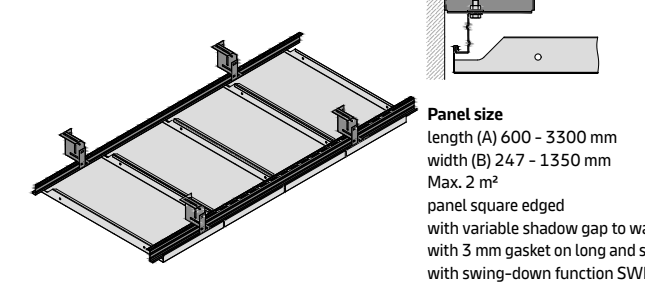

## Wall Solutions

■ **METAL Wallcoustic Element**  
Single wall absorber solution:  
Wall bracket

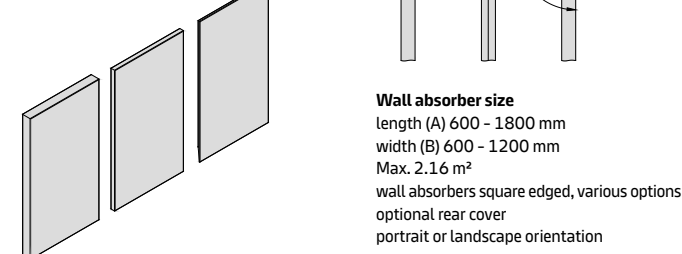

■ **METAL Wallcoustic Horizon 1000**  
Wall solution: C-Wall Profile

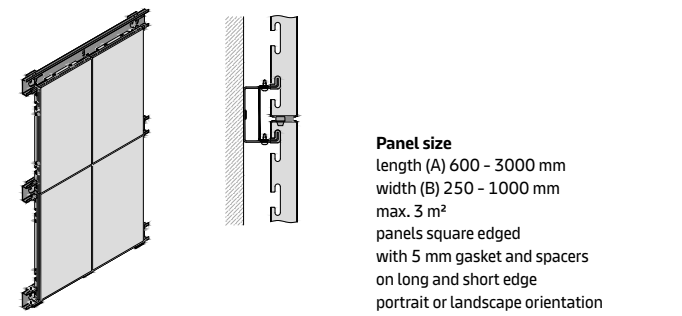

■ **METAL Wallcoustic Horizon 1100**  
Wall solution: U-Wall Profile

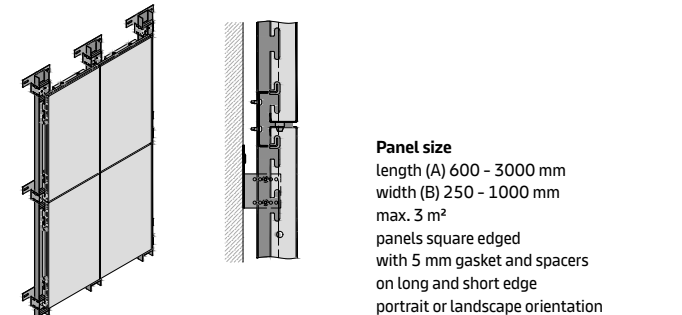

The availability of the dimensions shown here vary depending on the selected configuration (patterns, colours, additional performance, etc.).