

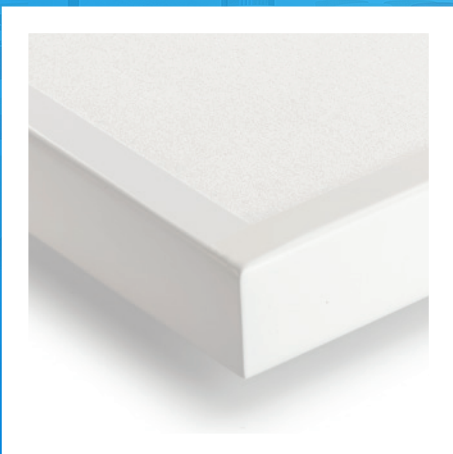











Horizontalios "Canopy" sistemos
MINERAL Sonic Line Arc
(THERMATEX® Sonic Arc)
Individualūs



- Sukurkite unikalų, elegantišką dizainą naudodami daugybę įgaubtų ir išgaubtų „MINERAL Sonic Arc“ akustinių elementų
- Žaiskite su pasirinktomis spalvomis, kad sukurtumėte įdomių kontrastingų efektų.
- „MINERAL Sonic Line Arc“ leidžia išreikšti savo kūrybiškumą ir paryškinti sritį naudojant naujus erdvinis efektus



Horizontalios "Canopy" sistemos
MINERAL Sonic Line Arc
 Individualūs

Edge details		MINERAL Sonic Line Arc Concave 	MINERAL Sonic Line Arc Convex 																					
Storis (mm)		35																						
Matmenys (mm)		1910 x 1180																						
Sistema		Vielos troseliai ir kabliai																						
Svoris		16.0 kg/vnt																						
Spalvos ir dizainas		 <p>  Balta  Granitas  Plienas  Žalias marmuras  Varis  Ažuolas  Žalvaris  Smiltainis  Betonas </p>																						
Garso sugertis		EN ISO 354 <table border="1"> <thead> <tr> <th>Dažnis(Hz)</th> <th>125</th> <th>250</th> <th>500</th> <th>1000</th> <th>2000</th> <th>4000</th> </tr> </thead> <tbody> <tr> <td>Ekvivalentinė absorbcija*</td> <td></td> <td></td> <td></td> <td></td> <td></td> <td></td> </tr> <tr> <td>Pakabos aukštis 185mm</td> <td>0.40</td> <td>1.60</td> <td>2.40</td> <td>2.70</td> <td>3.20</td> <td>3.40</td> </tr> </tbody> </table> <p>* Rodomos reikšmės yra 3 vienos trečdaliao oktavos juostos verčių vidurkis</p>		Dažnis(Hz)	125	250	500	1000	2000	4000	Ekvivalentinė absorbcija*							Pakabos aukštis 185mm	0.40	1.60	2.40	2.70	3.20	3.40
Dažnis(Hz)	125	250	500	1000	2000	4000																		
Ekvivalentinė absorbcija*																								
Pakabos aukštis 185mm	0.40	1.60	2.40	2.70	3.20	3.40																		
Ugnies reakcija		Euroclass A2-s1,d0 pagal EN 13501-1																						
Šviesos atspindėjimas		Iki 88%																						
Atsparumas drėgmei		90%																						
Valomumas	 																							
Tvarumas																								

MINERAL Sonic Line Arc Concave

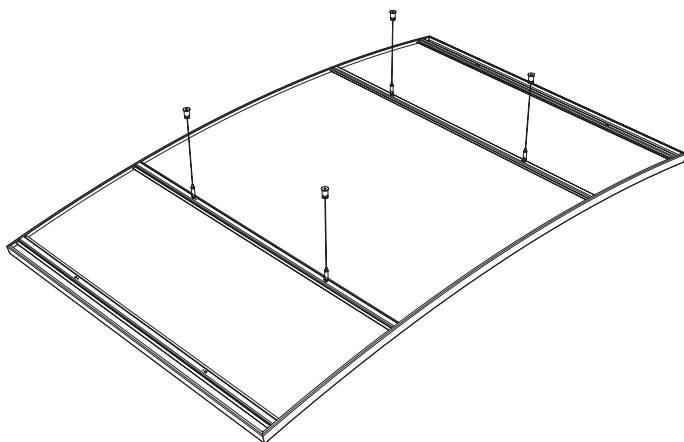

MINERAL Sonic Line Arc Convex

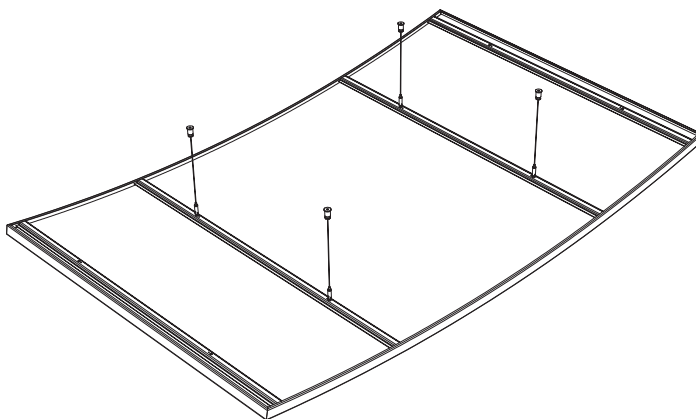

Akustiniai elementai pristatomi vientisi, todėl juos greitai ir lengva montuoti. Lankstus dizainas ir reguliuojamas pakabinimo aukštis naudojant plieninius trosus.