

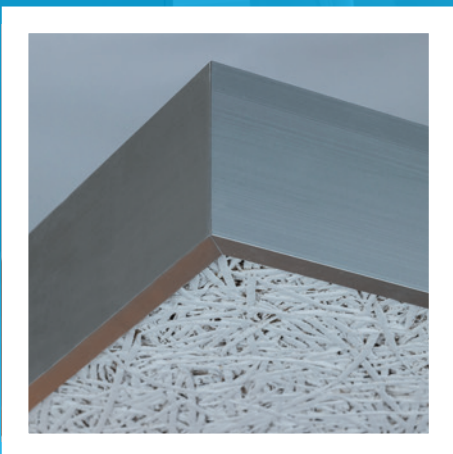











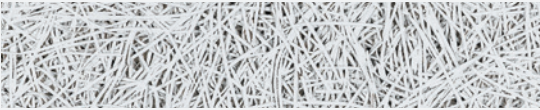
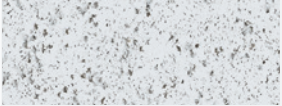

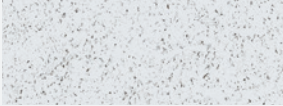









Floating Canopy Systems
HERADESIGN® Sky Line
(HERADESIGN® End Profile)
Individual



- HERADESIGN® Sky Line is an anodised profile edge piece, that can be fixed to the sides of the HERADESIGN® ceiling canopy
- HERADESIGN® Sky Line is available with a HERADESIGN® Superfine, Fine, Macro, Micro or Plano surface
- Quick and easy to install
- Available in Vario Design and RAL and NCS colours for HERADESIGN® cover layers



Floating Canopy Systems
HERADESIGN® Sky Line
 Individual

Surface 	HERADESIGN® Fine, Fine A2 		HERADESIGN® Superfine, Superfine A2 						
	HERADESIGN® Micro 	HERADESIGN® Macro 	HERADESIGN® Plano 						
	Edge details 		 AK-01	 GK	 AK-02/5				
	Thickness (mm) 	25							
Dimension of profile (mm) 	56/42mm, profile length 3000mm								
System 	Symmetrical profile for HERADESIGN® 25mm thick panels Metal or wooden double layer grid system for screw mounting								
Profile weight 	0.54 kg/m								
Colours 	Standard colours		vo Vario Design colours						
	 White <small>Similar to RAL 9010</small>	 Beige <small>Natural tone 13</small>	 Granite	 Steel	 Green Marble	 Copper	 Oak	 Brass	 Sandstone
	<ul style="list-style-type: none"> • The colour options listed refer to HERADESIGN® cover layers only. • Other colours from popular RAL and NCS colour systems are available. • Deviations in colour and visual appearance may occur due to the rough fibre and panel surface. 								
Fire reaction 	Euroclass B-s1,d0 and A2-s1,d0 according EN 13501-1								
Humidity resistance 	Suitable for rooms with a constant humidity of up to 90% For applications where there is a constant humidity in excess of 80%, construction physics advice is recommended								

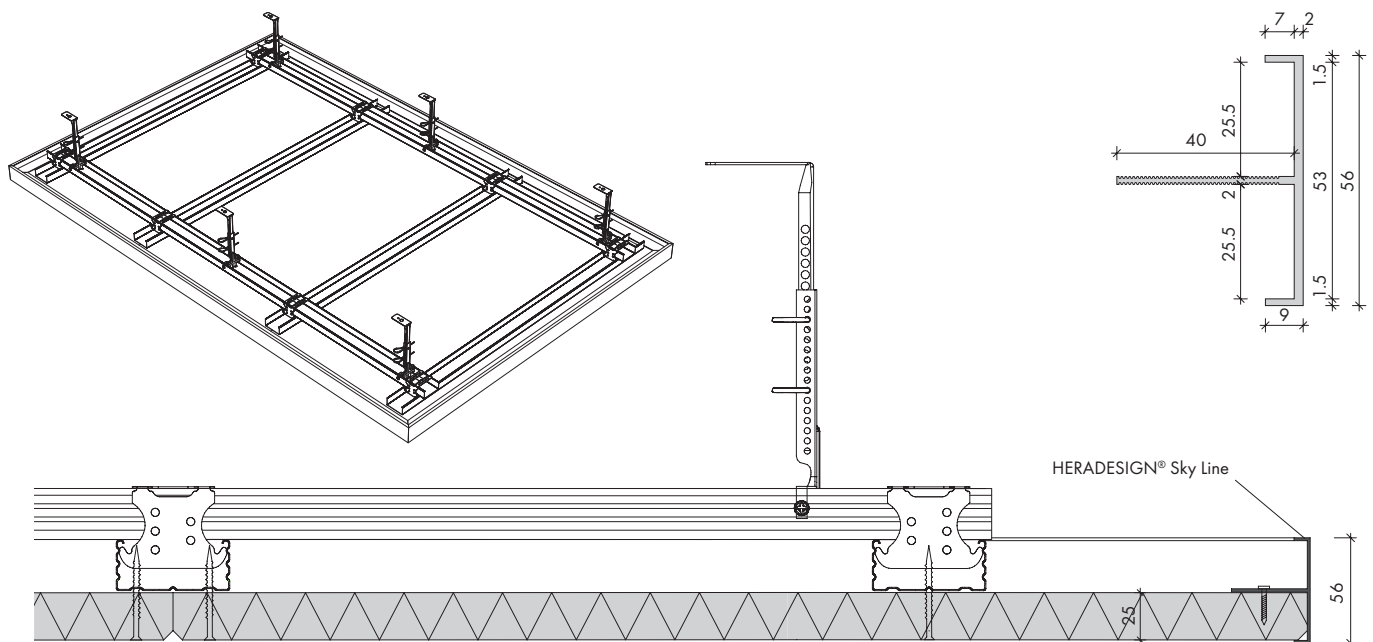

[Previous page] HERADESIGN® Sky Line (© Knauf Ceiling Solutions)

Options with this icon are available from our **Vario Design** range. Some combinations of colours and/or perforations are not available for every product. Products may vary from country to country. Please contact your local sales representative. For further information and legal notice, please visit our website. knaufceilingsolutions.com

07 / 2022