



***KNAUF***

***METAL***

PRODUCT BROCHURE

***Build on us.***



# METAL Ceiling Solutions

## **Innovative Designs for Modern Spaces**

Transform your interior with the sleek elegance of a metal ceiling. Ideal for contemporary spaces, our metal ceilings offer a sophisticated look combined with high durability and superior acoustic performances. The Knauf Ceiling Solutions Cradle to Cradle® Silver metal range provides an extensive palette of colours and perforation patterns, ensuring exceptional visual and acoustic experiences. Our bespoke metal solutions allow for complete customisation, from extra-wide panels for a seamless, monolithic appearance to trapezoidal shapes for dynamic, radial effects. Whether you prefer faceted, flat, or curved designs, our metal ceilings can be tailored in unique sizes, shapes, finishes, and perforations to ensure your project stands out. Discover the perfect blend of style and functionality with our innovative metal ceiling solutions.

# Index

<b>Introduction</b>	2
<b>Exposed Grid</b>	
METAL Board, METAL MicroLook 8, METAL Tegular 2, METAL Tegular 8	10
METAL Axal Vector	14
METAL R-L 201, METAL B-L 302, METAL B-H 300, METAL K-H 400	18
<b>Concealed Grid</b>	
METAL Q-Clip, METAL Q-Clip F, METAL R-Clip	22
METAL T-Clip F	26
METAL R-H 200, METAL Q-H 100 F, METAL R-H 215	30
METAL R-H 220, METAL Q-H 120 F	34
<b>Grille - Open Cell</b>	
METAL Grille Cellio	38
<b>Floating Ceilings - Canopies</b>	
METAL Sonic Element, METAL Sky Element Clip, METAL Sky Element Hook	42
<b>Linear &amp; Baffle Solutions</b>	
METAL Baffle Element	46
METAL Linear Lite	50
METAL Linear Blade	52
METAL Linear Stripe	54
<b>Free Span Corridor Solutions</b>	
METAL F-L 601, METAL F-Clip, METAL F-H 600, METAL F-H 600 Swing	56
<b>Wall Solutions</b>	
METAL Wallcoustic Element, METAL Wallcoustic Horizon 1000, METAL Wallcoustic Horizon 1100	60
<b>Parameter &amp; Performances</b>	64
Colours & Finishes	
Acoustics	
Fire Resistance	
Seismic	
Impact Resistance	
Clean Room	
Exterior	
Technical Glossary	76

# Shapes & Systems



## Exposed Grid

Exposed ceiling systems provide a modular aesthetic and are available in a variety of edge details.



## Concealed Grid

Concealed ceiling solutions create a continuous, monolithic look by concealing all of the grid system.



## Grille - Open Cell

Open cell metal tiles mask the plenum and provide 100% accessibility to lighting, ventilation and sprinklers with an homogeneous appearance and a variety of edge details.



## Floating Ceilings - Canopies

Open up an almost endless range of dramatic design possibilities with canopies that can be suspended from any soffit.

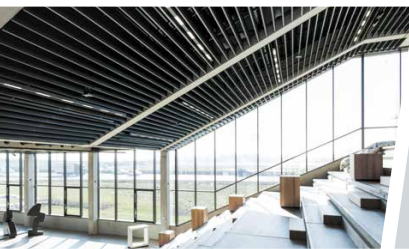

## Linear & Baffle Solutions

Discover the potential of baffle and linear solutions to create sleek and clean designs combined with functional excellence. Craft distinctive and memorable interiors with our wide array of materials, finishes, colours and configurations.



## Free Span Corridor Solutions

With easy installation and access to services, wall-to-wall corridor solutions require functionality to handle high traffic and design flexibility to connect key spaces seamlessly.



## Wall Solutions

Wall solutions come in a variety of designs to provide a stunning visual durable enough for high-impact or high traffic areas. Coordinate with ceilings and other interior finishes to create signature spaces.







## *Vario Design Features*

There is no limit to what you can achieve with Knauf Ceiling Solutions Vario Design range. From predefined Lay-In and Clip-In panels to variable module systems, baffles and canopies, all systems are configurable as part of the Vario Design portfolio providing additional technical performances, versatile shapes, dimensions, perforations, colours or acoustic infills to meet the specific design needs of your projects.

Our portfolio of configurable and bespoke metal ceilings and walls gives you the freedom and flexibility to create unique solutions to fit every space. Faceted, flat or curved, our metal ceilings include unique sizes, shapes, finishes and perforations to make your project stand out from the rest.



### **Colours and Finishes**

Metal ceilings come in a wide array of colours and finishes, allowing for a lot of design flexibility. With so many colours and finishes to choose from, metal ceilings can be a great way to add visual interest, define a space, and create the desired atmosphere in your project.

Besides standard colours, we can offer a wide range of RAL & NCS colours as well as performance coatings or visual effects.



### **Design Variations**

A choice of many different systems; Perforation and colour options; Concealed or exposed grids; Tiles easily removed or replaced



### **Aesthetics**

Crisp, clean, 'hi-tech' image; Linear or modular layouts, dimensional flexibility and specific shapes; Flat, curved or segmented forms



### **Services Integrations**

Fittings easily accommodated within tile cut-outs or modular



### **Swing-down Function**

The swing-down function is available for a selection of our metal ceiling solutions. It allows you to quickly swing down the ceiling to grant easy and complete access to the plenum, helping maintain any technical element located there.



### **Secure Function**

This function adds a concealed locking mechanism for metal ceilings, making them tamper-resistant and restricting access to the plenum. They are typically used in public areas with a generally low ceiling height, or psychiatric and juvenile wards.

# METAL Selector

	Design Layout						Material			Vario Design Options On Request										Features & Performances								
	Exposed Grid	Concealed Grid	Grille - Open cell	Floating Ceilings - Canopies	Linear & Baffle Solutions	Free Span Corridor Solutions	Wall Solutions	Post-coated galvanised steel	Pre-coated galvanised steel	Pre-coated aluminium	Dimensions	Shapes	Post-coated aluminium	Perforations	RAL & MGS colours	BioGuard finish	Wood Effect finish	Acoustic infills	Cut-outs	Grid alternatives	Acoustics	Secure function	Swing-down function	Clean room	Seismic	Impact resistance	Suitable for chilled ceilings	Exterior
METAL Board	■						■		■			■	■	■	■	■	■	■	■	■	■				■			
METAL MicroLook 8	■						■			■		■	■	■	■	■	■	■	■	■	■							
METAL Tegular 2	■						■					■	■	■	■	■	■	■	■		■			■	■			
METAL Tegular 8	■						■					■	■	■	■	■	■	■	■		■			■	■			
METAL Axal Vector	■						■						■	■	■	■	■	■	■		■	■						
METAL R-L 201	■						■			■	■	■	■	■	■	■	■	■	■	■	■							■
METAL B-L 302	■						■			■	■	■	■	■	■	■	■	■	■	■	■							
METAL B-H 300	■						■			■	■	■	■	■	■	■	■	■	■	■	■		■		■		■	
METAL K-H 400	■						■			■	■	■	■	■	■	■	■	■	■	■	■		■				■	
METAL Q-Clip		■					■					■	■	■	■	■	■	■	■	■	■	■	■	■				■
METAL Q-Clip F		■					■					■	■	■	■	■	■	■	■	■	■	■	■	■				■
METAL R-Clip		■					■					■	■	■	■	■	■	■	■	■	■	■	■	■				■
METAL T-Clip F *		■					■					■	■	■	■	■	■	■	■	■	■	■	■	■		■		
METAL R-H 200		■					■			■	■	■	■	■	■	■	■	■	■	■	■	■	■		■	■	■	
METAL Q-H 100 F		■					■					■	■	■	■	■	■	■	■	■	■	■	■					
METAL R-H 215		■					■			■	■	■	■	■	■	■	■	■	■	■	■	■	■	■		■		
METAL R-H 220 **		■					■			■	■	■	■	■	■	■	■	■	■	■	■	■	■					
METAL Q-H 120 F **		■					■					■	■	■	■	■	■	■	■	■	■	■	■					
METAL Grille Cellio			■					■																				
METAL Sonic Element				■			■			■	■	■	■	■	■	■	■	■	■	■	■	■						
METAL Sky Element Clip				■			■			■		■	■	■	■	■	■	■	■	■	■	■	■					
METAL Sky Element Hook				■			■			■		■	■	■	■	■	■	■	■	■	■	■	■					■
METAL Baffle Element					■		■			■		■	■	■	■	■	■	■	■	■	■	■	■					
METAL Linear Lite					■			■	■					■														
METAL Linear Blade					■			■	■					■														
METAL Linear Stripe					■			■	■					■		■												
METAL F-L 601						■	■			■	■	■	■	■	■	■	■	■	■	■	■	■						
METAL F-Clip						■	■			■		■	■	■	■	■	■	■	■	■	■	■	■	■				
METAL F-H 600						■	■			■	■	■	■	■	■	■	■	■	■	■	■	■	■					■
METAL F-H 600 Swing						■	■			■		■	■	■	■	■	■	■	■	■	■	■	■					■
METAL Wallcoustic Element						■	■			■	■	■	■	■	■	■	■	■	■	■	■	■	■					
METAL Wallcoustic Horizon 1000						■	■			■			■	■	■	■	■	■	■	■	■	■	■					
METAL Wallcoustic Horizon 1100						■	■			■			■	■	■	■	■	■	■	■	■	■	■					

Standard Suspension System

	15 mm T-grid	24 mm T-grid	U-Profile + L-Profile	U-Profile + Bandraster	U-Profile + C-Profile	U-Profile + DP12 A-Bar	U-Profile + J-Bar	U-Profile + H-Profile 28	U-Profile + H-Profile 35	U-Profile + Hanger	U-Profile cross-connected	C-Channel + Spring T	Crossing Box + C-Profile	Carrier Profile	Wall Bracket + Half DP12 A-Bar	Wall Bracket + J-Bar	Wall Bracket + G-Profile	Perimeter trim	Hanging wire	Wall bracket	C-Wall Profile	U-Wall Profile	Budget Price	
METAL Board		■																					LOW	
METAL MicroLook 8	■																						LOW	
METAL Tegular 2		■																					LOW	
METAL Tegular 8		■																					LOW	
METAL Axal Vector		■																					MEDIUM	
METAL R-L 201			■																				MEDIUM	
METAL B-L 302				■																			MEDIUM	
METAL B-H 300					■																		HIGH	
METAL K-H 400													■										HIGH	
METAL Q-Clip						■																	MEDIUM	
METAL Q-Clip F						■																	MEDIUM	
METAL R-Clip						■																	MEDIUM	
METAL T-Clip F *												■											MEDIUM	
METAL R-H 200							■																HIGH	
METAL Q-H 100 F							■																MEDIUM	
METAL R-H 215								■															HIGH	
METAL R-H 220 **								■															HIGH	
METAL Q-H 120 F **								■															MEDIUM	
METAL Grille Cellio	■																						LOW	
METAL Sonic Element																			■				HIGH	
METAL Sky Element Clip						■																	HIGH	
METAL Sky Element Hook											■												HIGH	
METAL Baffle Element										■									■				MEDIUM	
METAL Linear Lite														■									LOW	
METAL Linear Blade														■									LOW	
METAL Linear Stripe														■									MEDIUM	
METAL F-L 601																		■					MEDIUM	
METAL F-Clip															■								MEDIUM	
METAL F-H 600																■							MEDIUM	
METAL F-H 600 Swing																	■						HIGH	
METAL Wallcoustic Element																				■			HIGH	
METAL Wallcoustic Horizon 1000																						■	HIGH	
METAL Wallcoustic Horizon 1100																							■	HIGH

\* UK market only  
\*\* Swiss market only

# KNAUF

## **METAL** **Board, MicroLook 8,** **Tegular 2, Tegular 8** *Exposed Grid*

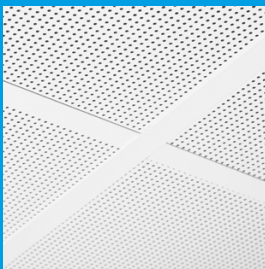

© Simon Miles

- Lay-In tiles are available in a variety of edge details for installation on standard 15 and 24 mm suspension systems.
- Cost effective ceiling solution.
- Additional design options available as part of our Vario Design range.
- Used in a variety of ceiling areas: from small service rooms to large commercial office buildings and major transportation terminals.

## **Build on us.**

## METAL Board

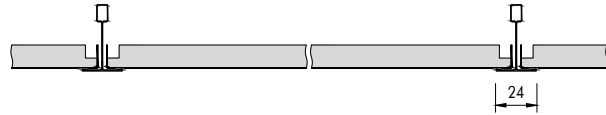
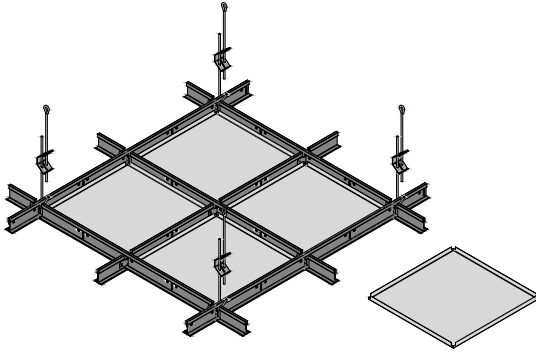

Tiles  
 Material post-coated galvanised steel 0.5 mm  
 Edge detail square edged lay-in  
 Modules 600 x 600, 625 x 625, 1200 x 600 mm

Suspension system  
 Standard 24 mm T-grid, butt-cut (System C)  
 Optional 15 mm T-grid, butt-cut (System C)

## METAL MicroLook 8

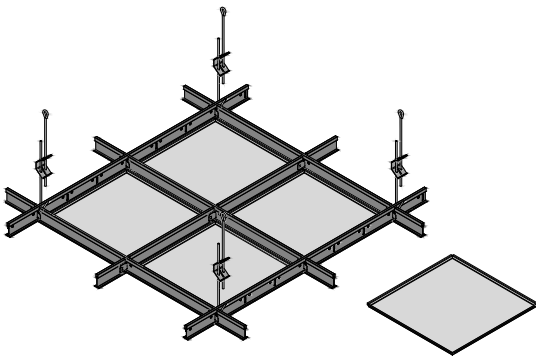

Tiles  
 Material post-coated galvanised steel 0.5 mm  
 Edge detail square edged lay-in, with 8 mm drop  
 Modules 600 x 600, 1200 x 600 mm

Suspension system  
 Standard 15 mm T-grid (System C)  
 Optional Perfectline

## METAL Tegular 2

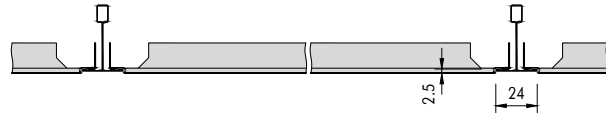
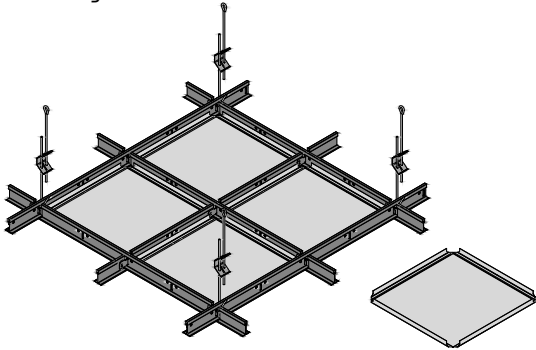

Tiles  
 Material post-coated galvanised steel 0.5 mm  
 Edge detail square edged lay-in, with 2.5 mm drop  
 Modules 600 x 600, 625 x 625 mm

Suspension system  
 Standard 24 mm T-grid, butt-cut (System C)

## METAL Tegular 8

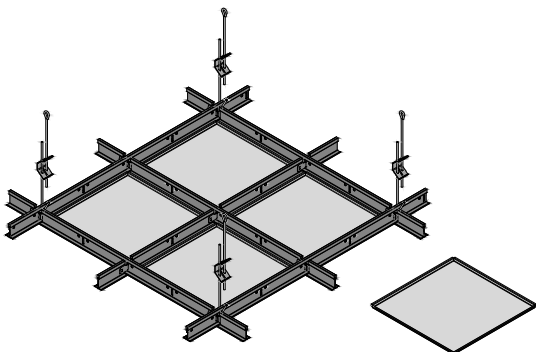

Tiles  
 Material post-coated galvanised steel 0.5 mm  
 Edge detail square edged lay-in  
 Modules 600 x 600, 625 x 625, 1200 x 600 mm,  
 with 8 mm drop

Suspension system  
 Standard 24 mm T-grid (System C)

METAL Board

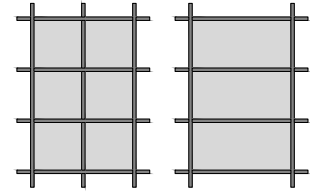
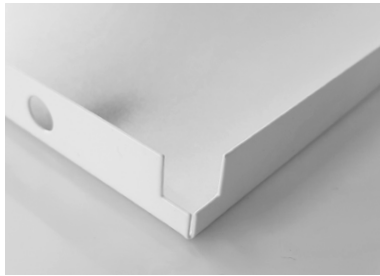
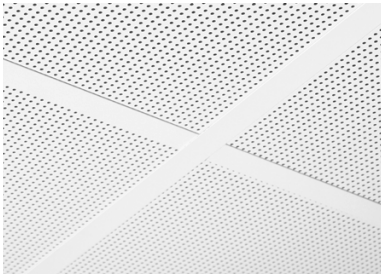

METAL MicroLook 8

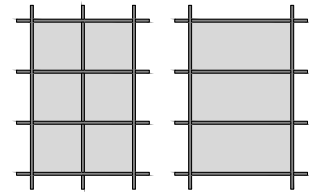
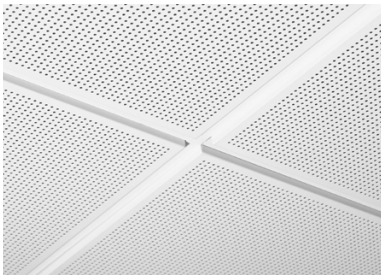

METAL Tegular 2

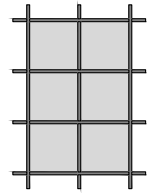
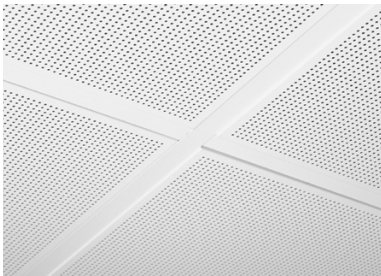

METAL Tegular 8

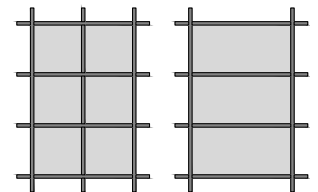
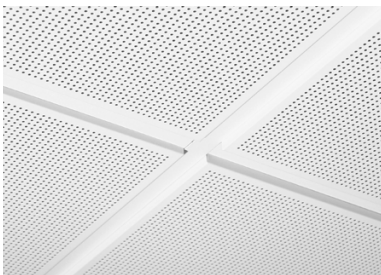

**Hold-down clip option**

METAL MicroLook 8      METAL Tegular 8

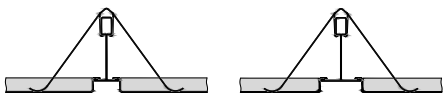

The hold down clip option can be used to apply light pressure to the top of the tiles. This is not a security clip solution. Access to the plenum is made more difficult by the use of hold-down clips.

	VarioDesign options on request										Features & performances							
	Dimensions	Shapes	Post-coated aluminium	Perforations	RAL & NCS colours	BioGuard finish	Wood effect finish	Acoustic infills	Cut-outs	Grid alternatives	Secure function	Swing-down function	Clean room*	Seismic*	Impact resistance*	Fire resistance*	Suitable for chilled ceilings	Exterior*
<b>METAL Board</b>	■		■	■	■	■	■	■	■	■			■					
<b>METAL MicroLook 8</b>	■		■	■	■	■	■	■	■	■								
<b>METAL Tegular 2</b>			■	■	■	■	■	■	■				■	■				
<b>METAL Tegular 8</b>	■		■	■	■	■	■	■	■				■	■				

\* see separate datasheet

Characteristic	Detailed information																																																																																																																			
Colour / Perforations	RAL 9016                      RAL 9010                      RAL 9006                      RAL 9007                      RAL 9005	Unperforated                      Rg 0701                      Rg 0704                      Rd 1522                      Rg 2516																																																																																																																		
	further RAL & NCS colours on request																																																																																																																			
Acoustic infills	Black acoustic fleece VLSRX																																																																																																																			
Weight	3.2 - 3.9 kg/m <sup>2</sup>																																																																																																																			
	Weight varies depending on the perforation and acoustic infill.																																																																																																																			
Acoustics	<table border="1"> <thead> <tr> <th rowspan="3"></th> <th colspan="10">EN ISO 354</th> <th>EN ISO 10848-2</th> <th>EN ISO 10140-2</th> </tr> <tr> <th rowspan="2">α<sub>w</sub></th> <th rowspan="2">Cavity [mm]</th> <th rowspan="2">Class</th> <th colspan="6">Frequency (Hz) α<sub>p</sub></th> <th rowspan="2">NRC</th> <th rowspan="2">D<sub>n,f,w</sub> [dB]</th> <th rowspan="2">R<sub>w</sub> [dB]</th> <th rowspan="2">CAC [dB]</th> </tr> <tr> <th>125</th> <th>250</th> <th>500</th> <th>1000</th> <th>2000</th> <th>4000</th> </tr> </thead> <tbody> <tr> <td>Unperforated</td> <td>0.10(L)</td> <td>200</td> <td>NC</td> <td>0.40</td> <td>0.20</td> <td>0.10</td> <td>0.10</td> <td>0.10</td> <td>0.15</td> <td>0.15</td> <td>0.15</td> <td>34</td> <td>19</td> <td>35</td> </tr> <tr> <td>Rg 0701 + VLSRX</td> <td>0.65(LM)</td> <td>200</td> <td>C</td> <td>0.50</td> <td>0.85</td> <td>0.90</td> <td>0.65</td> <td>0.60</td> <td>0.50</td> <td>0.75</td> <td>0.75</td> <td>19</td> <td>10</td> <td>20</td> </tr> <tr> <td>Rg 0704 + VLSRX</td> <td>0.80(L)</td> <td>200</td> <td>B</td> <td>0.45</td> <td>0.85</td> <td>0.95</td> <td>0.75</td> <td>0.75</td> <td>0.70</td> <td>0.85</td> <td>19</td> <td>10</td> <td>19</td> </tr> <tr> <td>Rd 1522 + VLSRX</td> <td>0.60</td> <td>200</td> <td>C</td> <td>0.25</td> <td>0.60</td> <td>0.75</td> <td>0.50</td> <td>0.60</td> <td>0.60</td> <td>0.60</td> <td>14</td> <td>6</td> <td>15</td> </tr> <tr> <td>Rg 2516 + VLSRX</td> <td>0.70</td> <td>200</td> <td>C</td> <td>0.30</td> <td>0.70</td> <td>0.85</td> <td>0.60</td> <td>0.70</td> <td>0.70</td> <td>0.70</td> <td>16</td> <td>6</td> <td>16</td> </tr> </tbody> </table>													EN ISO 354										EN ISO 10848-2	EN ISO 10140-2	α <sub>w</sub>	Cavity [mm]	Class	Frequency (Hz) α <sub>p</sub>						NRC	D <sub>n,f,w</sub> [dB]	R <sub>w</sub> [dB]	CAC [dB]	125	250	500	1000	2000	4000	Unperforated	0.10(L)	200	NC	0.40	0.20	0.10	0.10	0.10	0.15	0.15	0.15	34	19	35	Rg 0701 + VLSRX	0.65(LM)	200	C	0.50	0.85	0.90	0.65	0.60	0.50	0.75	0.75	19	10	20	Rg 0704 + VLSRX	0.80(L)	200	B	0.45	0.85	0.95	0.75	0.75	0.70	0.85	19	10	19	Rd 1522 + VLSRX	0.60	200	C	0.25	0.60	0.75	0.50	0.60	0.60	0.60	14	6	15	Rg 2516 + VLSRX	0.70	200	C	0.30	0.70	0.85	0.60	0.70	0.70	0.70	16	6	16
	EN ISO 354										EN ISO 10848-2	EN ISO 10140-2																																																																																																								
	α <sub>w</sub>	Cavity [mm]	Class	Frequency (Hz) α <sub>p</sub>						NRC	D <sub>n,f,w</sub> [dB]	R <sub>w</sub> [dB]		CAC [dB]																																																																																																						
				125	250	500	1000	2000	4000																																																																																																											
Unperforated	0.10(L)	200	NC	0.40	0.20	0.10	0.10	0.10	0.15	0.15	0.15	34	19	35																																																																																																						
Rg 0701 + VLSRX	0.65(LM)	200	C	0.50	0.85	0.90	0.65	0.60	0.50	0.75	0.75	19	10	20																																																																																																						
Rg 0704 + VLSRX	0.80(L)	200	B	0.45	0.85	0.95	0.75	0.75	0.70	0.85	19	10	19																																																																																																							
Rd 1522 + VLSRX	0.60	200	C	0.25	0.60	0.75	0.50	0.60	0.60	0.60	14	6	15																																																																																																							
Rg 2516 + VLSRX	0.70	200	C	0.30	0.70	0.85	0.60	0.70	0.70	0.70	16	6	16																																																																																																							
	α <sub>w</sub> : as per EN ISO 11654 / NRC: as per ASTM C 423-01 / D <sub>n,f,w</sub> : as per EN ISO 717-1 / CAC: as per ASTM E 413-10																																																																																																																			
Fire reaction	Unperforated: <b>Euroclass A1</b> ; Rg 0701 / Rg 0704 with acoustic fleece VLSRX: <b>Euroclass A2-s1, d0</b> ; Rd 1522 / Rg 2516 with acoustic fleece VLSRX: <b>Euroclass A2-s2, d0</b> ; as per EN 13501-1																																																																																																																			
Light reflectance	RAL 9010 unperforated: <b>85%</b> ; RAL 9010 Rd 1522: <b>66%</b> ; RAL 9010 Rg 0701: <b>83%</b> ; RAL 9010 Rg 2516: <b>73%</b> ; RAL 9010 Rg 0704: <b>82%</b>																																																																																																																			
Humidity resistance	<b>90% RH</b>																																																																																																																			
Indoor air quality	A+                      E1                      IAC Gold																																																																																																																			
Sustainability/ Cleanability	17.3% (2023)                      ISO 9001                      EN 15804                      CRADLE TO CRADLE SILVER																																																																																																																			

# KNAUF

## METAL Axal Vector

Exposed Grid



© Philip Durrant

- An easy to install and flexible system which offers a diversity of design and applications, and can be installed with a very low void depth.
- Semi-concealed solution with 7mm reveal detailing for a monolithic effect.
- Additional design options available as part of our Vario Design range.
- Downwardly accessible and easy to install / remove without tools.
- Used in a variety of ceiling areas: from small to large commercial office buildings and major transportation terminals.

**Build on us.**

METAL Axal Vector

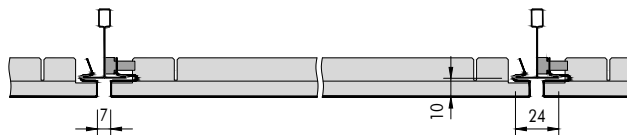
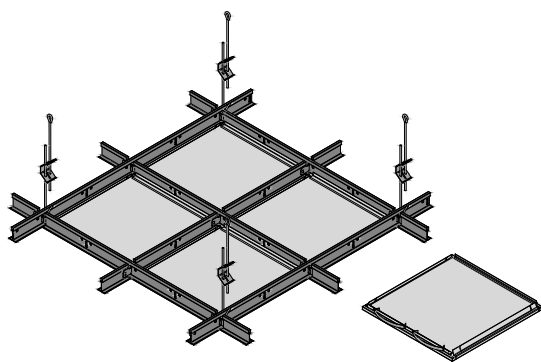

Tiles  
Material post-coated galvanised steel 0.5 mm  
Edge detail square edged  
Modules 600 x 600 mm

Suspension system  
Standard 24 mm T-grid (System C)

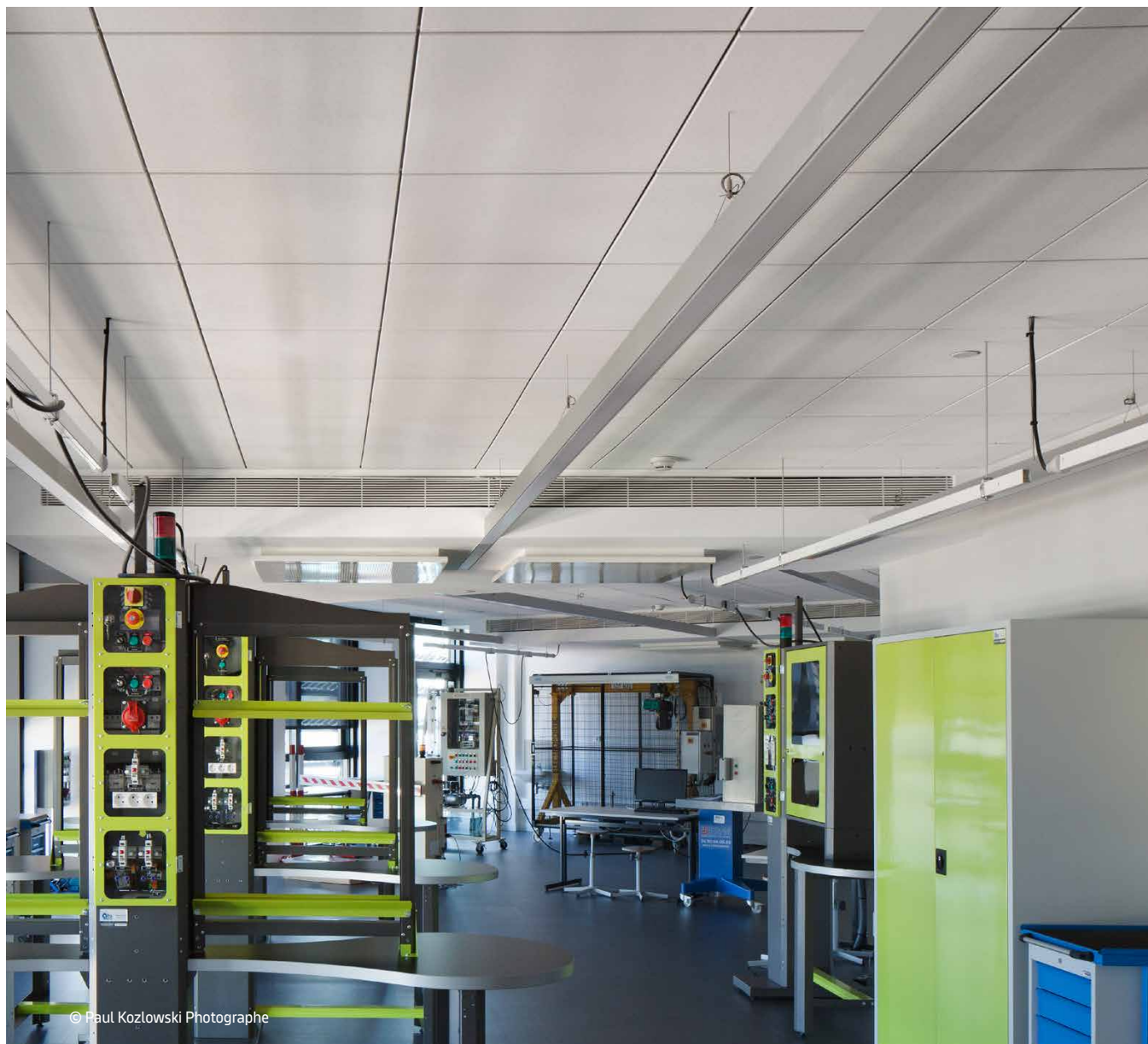

© Paul Kozłowski Photographie

METAL Axal Vector

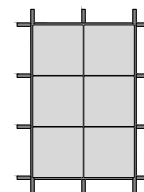
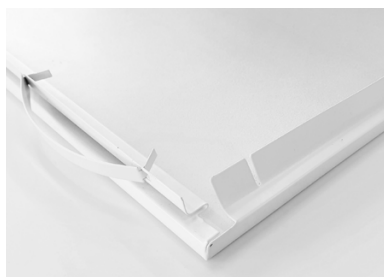

For security applications, METAL Axal Vector can be used where unauthorised removal of tiles is not desirable. This is achieved by installing tiles as normal and folding down the tabs.



© Paul Kozlowski Photographie

	VarioDesign options on request									Features & performances								
	Dimensions	Shapes	Post-coated aluminium	Perforations	RAL & NCS colours	BioGuard finish	Wood effect finish	Acoustic infills	Cut-outs	Grid alternatives	Secure function	Swing-down function	Clean room*	Seismic*	Impact resistance*	Fire resistance*	Suitable for chilled ceilings	Exterior*
<b>METAL Axal Vector</b>				■	■	■	■	■	■		■							

\* see separate datasheet

Characteristic	Detailed information																																																																																																												
Colour / Perforations	 RAL 9016   RAL 9010   RAL 9006   RAL 9007   RAL 9005 further RAL & NCS colours on request	 Unperforated   Rg 0701   Rg 0704   Rd 1522   Rg 2516 further options see acoustic datasheet																																																																																																											
Acoustic infills	Black acoustic fleece VLSRX further options see acoustic datasheet																																																																																																												
Weight	 <b>3.9 - 4.7 kg/m<sup>2</sup></b> Weight varies depending on the perforation and acoustic infill.																																																																																																												
Acoustics	 <table border="1"> <thead> <tr> <th rowspan="3"></th> <th colspan="10">EN ISO 354</th> <th>EN ISO 10848-2</th> <th>EN ISO 10140-2</th> <th rowspan="3">CAC [dB]</th> </tr> <tr> <th rowspan="2">α<sub>w</sub></th> <th rowspan="2">Cavity [mm]</th> <th rowspan="2">Class</th> <th colspan="6">Frequency (Hz) α<sub>p</sub></th> <th rowspan="2">NRC</th> <th rowspan="2">D<sub>n,w</sub> [dB]</th> <th rowspan="2">R<sub>w</sub> [dB]</th> </tr> <tr> <th>125</th> <th>250</th> <th>500</th> <th>1000</th> <th>2000</th> <th>4000</th> </tr> </thead> <tbody> <tr> <td>Unperforated</td> <td>0.10(L)</td> <td>200</td> <td>NC</td> <td>0.40</td> <td>0.20</td> <td>0.10</td> <td>0.10</td> <td>0.10</td> <td>0.10</td> <td>0.15</td> <td>0.15</td> <td>34</td> <td>19</td> <td>35</td> </tr> <tr> <td>Rg 0701 + VLSRX</td> <td>0.65(LM)</td> <td>200</td> <td>C</td> <td>0.50</td> <td>0.85</td> <td>0.90</td> <td>0.65</td> <td>0.60</td> <td>0.50</td> <td>0.75</td> <td>0.75</td> <td>19</td> <td>10</td> <td>20</td> </tr> <tr> <td>Rg 0704 + VLSRX</td> <td>0.80(L)</td> <td>200</td> <td>B</td> <td>0.45</td> <td>0.85</td> <td>0.95</td> <td>0.75</td> <td>0.75</td> <td>0.70</td> <td>0.85</td> <td>0.85</td> <td>19</td> <td>10</td> <td>19</td> </tr> <tr> <td>Rd 1522 + VLSRX</td> <td>0.60</td> <td>200</td> <td>C</td> <td>0.25</td> <td>0.60</td> <td>0.75</td> <td>0.50</td> <td>0.60</td> <td>0.60</td> <td>0.60</td> <td>0.60</td> <td>14</td> <td>6</td> <td>15</td> </tr> <tr> <td>Rg 2516 + VLSRX</td> <td>0.70</td> <td>200</td> <td>C</td> <td>0.30</td> <td>0.70</td> <td>0.85</td> <td>0.60</td> <td>0.70</td> <td>0.70</td> <td>0.70</td> <td>0.70</td> <td>16</td> <td>6</td> <td>16</td> </tr> </tbody> </table> α <sub>w</sub> : as per EN ISO 11654 / NRC: as per ASTM C 423-01 / D <sub>n,w</sub> : as per EN ISO 717-1 / CAC: as per ASTM E 413-10		EN ISO 354										EN ISO 10848-2	EN ISO 10140-2	CAC [dB]	α <sub>w</sub>	Cavity [mm]	Class	Frequency (Hz) α <sub>p</sub>						NRC	D <sub>n,w</sub> [dB]	R <sub>w</sub> [dB]	125	250	500	1000	2000	4000	Unperforated	0.10(L)	200	NC	0.40	0.20	0.10	0.10	0.10	0.10	0.15	0.15	34	19	35	Rg 0701 + VLSRX	0.65(LM)	200	C	0.50	0.85	0.90	0.65	0.60	0.50	0.75	0.75	19	10	20	Rg 0704 + VLSRX	0.80(L)	200	B	0.45	0.85	0.95	0.75	0.75	0.70	0.85	0.85	19	10	19	Rd 1522 + VLSRX	0.60	200	C	0.25	0.60	0.75	0.50	0.60	0.60	0.60	0.60	14	6	15	Rg 2516 + VLSRX	0.70	200	C	0.30	0.70	0.85	0.60	0.70	0.70	0.70	0.70	16	6	16	
	EN ISO 354										EN ISO 10848-2	EN ISO 10140-2	CAC [dB]																																																																																																
	α <sub>w</sub>		Cavity [mm]	Class	Frequency (Hz) α <sub>p</sub>						NRC	D <sub>n,w</sub> [dB]		R <sub>w</sub> [dB]																																																																																															
		125			250	500	1000	2000	4000																																																																																																				
Unperforated	0.10(L)	200	NC	0.40	0.20	0.10	0.10	0.10	0.10	0.15	0.15	34	19	35																																																																																															
Rg 0701 + VLSRX	0.65(LM)	200	C	0.50	0.85	0.90	0.65	0.60	0.50	0.75	0.75	19	10	20																																																																																															
Rg 0704 + VLSRX	0.80(L)	200	B	0.45	0.85	0.95	0.75	0.75	0.70	0.85	0.85	19	10	19																																																																																															
Rd 1522 + VLSRX	0.60	200	C	0.25	0.60	0.75	0.50	0.60	0.60	0.60	0.60	14	6	15																																																																																															
Rg 2516 + VLSRX	0.70	200	C	0.30	0.70	0.85	0.60	0.70	0.70	0.70	0.70	16	6	16																																																																																															
Fire reaction	 Unperforated: <b>Euroclass A1</b> ; Rg 0701 / Rg 0704 with acoustic fleece VLSRX: <b>Euroclass A2-s1, d0</b> ; Rd 1522 / Rg 2516 with acoustic fleece VLSRX: <b>Euroclass A2-s2, d0</b> ; as per EN 13501-1																																																																																																												
Light reflectance	 RAL 9010 unperforated: <b>85%</b> ; RAL 9010 Rd 1522: <b>66%</b> ; RAL 9010 Rg 0701: <b>83%</b> ; RAL 9010 Rg 2516: <b>73%</b> ; RAL 9010 Rg 0704: <b>82%</b>																																																																																																												
Humidity resistance	 <b>90% RH</b>																																																																																																												
Indoor air quality	 A+   E1   IAC Gold																																																																																																												
Sustainability	 EN ISO 14021   ISO 9001 ISO 14001   EN 15804   cradle to cradle SILVER																																																																																																												
Cleanability																																																																																																													

# KNAUF

## **METAL** **R-L201, B-L302,** **B-H300, K-H400**

*Exposed Grid*

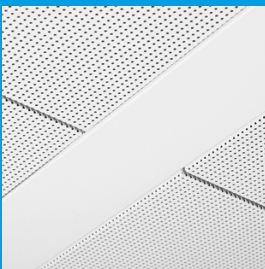

© Insightful Environments

- Lay-in and hook-on systems which combine functionality with stylish simplicity and versatility by creating a linear technical zone.
- Fully configurable large size panels.
- Additional design options available as part of our Vario Design range.
- Ideal for large spaces and office environments.

***Build on us.***

## METAL R-L 201

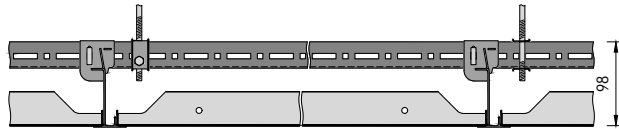
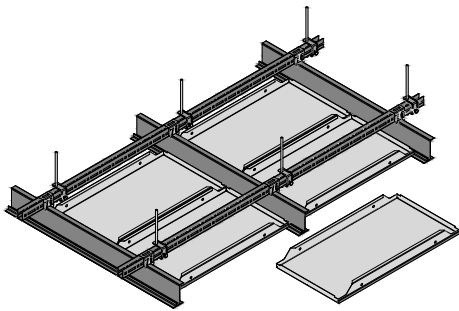

Panels	
Material	post-coated galvanised steel 0.6 / 0.7 mm
Edge detail	square edged lay-in, with 3 mm gasket on long edge
Dimensions	length (A) 600 - 3300 mm / width (B) 247 - 1350 mm
Panel size	max. 2 m <sup>2</sup>

Suspension system	
Standard	U-Profile + L-Profile 38 mm
Optional	various, on request
Features	radial layout with trapezoidal panels

## METAL B-L 302

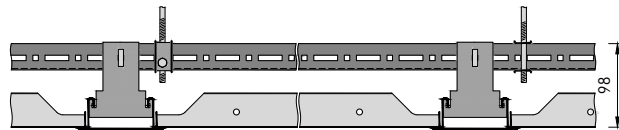
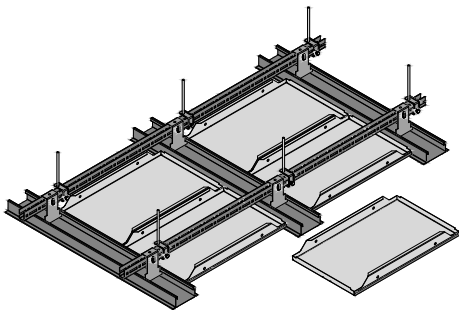

Panels	
Material	post-coated galvanised steel 0.6 / 0.7 mm
Edge detail	square edged lay-in, with 3 mm gasket on long edge
Dimensions	length (A) 600 - 3300 mm / width (B) 247 - 1350 mm
Panel size	max. 2 m <sup>2</sup>

Suspension system	
Standard	U-Profile + Bandraster 100 mm
Features	crossing Bandraster for tartan layout radial layout with trapezoidal panels

## METAL B-H 300

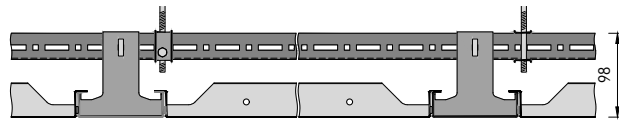
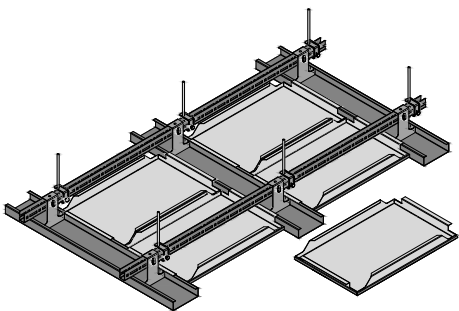

Panels	
Material	post-coated galvanised steel 0.6 / 0.7 mm
Edge detail	square edged hook-on, with 3 mm gasket on long edge both short edges
Dimensions	length (A) 600 - 3300 mm / width (B) 247 - 1350 mm
Panel size	max. 2 m <sup>2</sup>

Suspension system	
Standard	U-Profile + C-Profile 100 mm
Optional	C-Profile widths (50 - 300 mm) and further suspension options
Features	hinge-down function EASY and HOOK, swing-down function SWING crossing C-Profile for tartan layout radial layout with trapezoidal panels

## METAL K-H 400

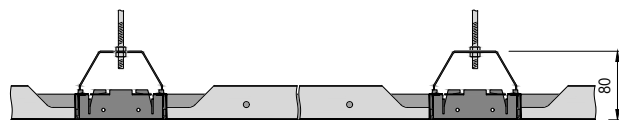
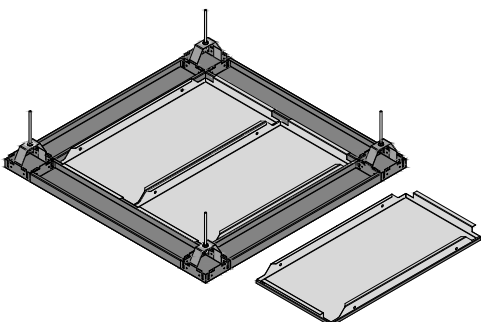

Panels	
Material	post-coated galvanised steel 0.6 / 0.7 mm
Edge detail	square edged hook-on, with 3 mm gasket on long edge and both short edges
Dimensions	length (A) 600 - 2850 mm / width (B) 247 - 1350 mm
Panel size	max. 2 m <sup>2</sup>

Suspension system	
Standard	Crossing box & C-Profile 100 mm
Optional	Crossing box & C-Profile widths (70 - 300 mm) and shapes
Features	hinge-down function EASY and HOOK, swing-down function SWING various layout options

METAL R-L 201

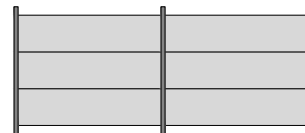
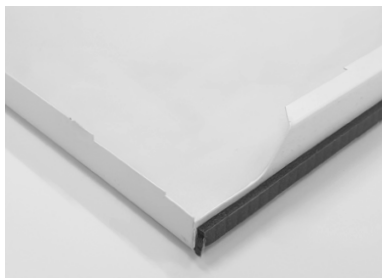

METAL B-L 302

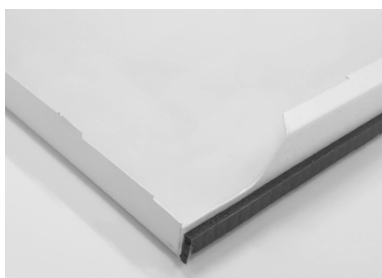
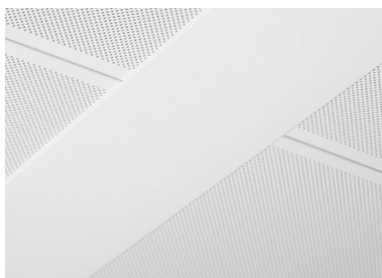

METAL B-H 300

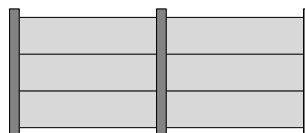

METAL K-H 400

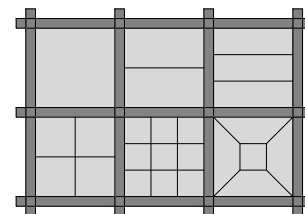

**METAL B-H 300 & METAL K-H 400 panel options**

Hinge-down function EASY

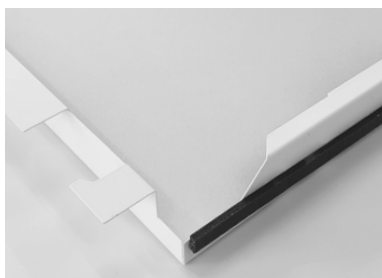

Hinge-down function HOOK

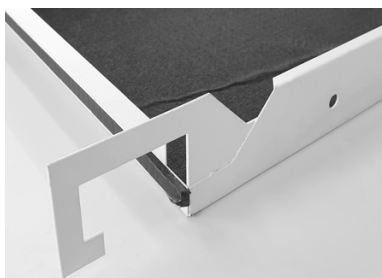

Swing-down function SWING



	VarioDesign options on request										Features & performances					
	Dimensions	Shapes	Post-coated aluminium	Perforations	RAL & NCS colours	BioGuard finish	Wood effect finish	Acoustic infills	Cut-outs	Grid alternatives	Secure function	Swing-down function	Clean room*	Seismic*	Impact resistance*	Suitable for chilled ceilings
<b>METAL R-L 201</b>	■	■	■	■	■	■	■	■	■	■					■	
<b>METAL B-L 302</b>	■	■	■	■	■	■	■	■	■	■						
<b>METAL B-H 300</b>	■	■	■	■	■	■	■	■	■	■		■			■	
<b>METAL K-H 400</b>	■	■	■	■	■	■	■	■	■	■		■			■	

\* see separate datasheet

Characteristic	Detailed information																																																																																																												
Colour / Perforations	RAL 9016                      RAL 9010                      RAL 9006                      RAL 9007                      RAL 9005 further RAL & NCS colours on request	Unperforated                      Rg 0701                      Rg 0704                      Rd 1522                      Rg 2516 further options see acoustic datasheet																																																																																																											
Acoustic infills	Black acoustic fleece VLSRX further options see acoustic datasheet																																																																																																												
Weight	<b>5.0 - 6.9 kg/m<sup>2</sup></b> Weight varies depending on the perforation and acoustic infill.																																																																																																												
Acoustics	<table border="1"> <thead> <tr> <th rowspan="3"></th> <th colspan="10">EN ISO 354</th> <th>EN ISO 10848-2</th> <th>EN ISO 10140-2</th> </tr> <tr> <th rowspan="2"><math>\alpha_w</math></th> <th rowspan="2">Cavity [mm]</th> <th rowspan="2">Class</th> <th colspan="6">Frequency (Hz) <math>\alpha_p</math></th> <th rowspan="2">NRC</th> <th rowspan="2"><math>D_{n,w}</math> [dB]</th> <th rowspan="2"><math>R_w</math> [dB]</th> <th rowspan="2">CAC [dB]</th> </tr> <tr> <th>125</th> <th>250</th> <th>500</th> <th>1000</th> <th>2000</th> <th>4000</th> </tr> </thead> <tbody> <tr> <td>Unperforated</td> <td>0.10(L)</td> <td>200</td> <td>NC</td> <td>0.40</td> <td>0.20</td> <td>0.10</td> <td>0.10</td> <td>0.10</td> <td>0.10</td> <td>0.15</td> <td>0.15</td> <td>34</td> <td>19</td> <td>35</td> </tr> <tr> <td>Rg 0701 + VLSRX</td> <td>0.65(LM)</td> <td>200</td> <td>C</td> <td>0.50</td> <td>0.85</td> <td>0.90</td> <td>0.65</td> <td>0.60</td> <td>0.50</td> <td>0.75</td> <td>0.75</td> <td>19</td> <td>10</td> <td>20</td> </tr> <tr> <td>Rg 0704 + VLSRX</td> <td>0.80(L)</td> <td>200</td> <td>B</td> <td>0.45</td> <td>0.85</td> <td>0.95</td> <td>0.75</td> <td>0.75</td> <td>0.70</td> <td>0.85</td> <td>0.85</td> <td>19</td> <td>10</td> <td>19</td> </tr> <tr> <td>Rd 1522 + VLSRX</td> <td>0.60</td> <td>200</td> <td>C</td> <td>0.25</td> <td>0.60</td> <td>0.75</td> <td>0.50</td> <td>0.60</td> <td>0.60</td> <td>0.60</td> <td>0.60</td> <td>14</td> <td>6</td> <td>15</td> </tr> <tr> <td>Rg 2516 + VLSRX</td> <td>0.70</td> <td>200</td> <td>C</td> <td>0.30</td> <td>0.70</td> <td>0.85</td> <td>0.60</td> <td>0.70</td> <td>0.70</td> <td>0.70</td> <td>0.70</td> <td>16</td> <td>6</td> <td>16</td> </tr> </tbody> </table> <p><math>\alpha_w</math>: as per EN ISO 11654 / NRC: as per ASTM C 423-01 / <math>D_{n,w}</math>: as per EN ISO 717-1 / CAC: as per ASTM E 413-10</p>			EN ISO 354										EN ISO 10848-2	EN ISO 10140-2	$\alpha_w$	Cavity [mm]	Class	Frequency (Hz) $\alpha_p$						NRC	$D_{n,w}$ [dB]	$R_w$ [dB]	CAC [dB]	125	250	500	1000	2000	4000	Unperforated	0.10(L)	200	NC	0.40	0.20	0.10	0.10	0.10	0.10	0.15	0.15	34	19	35	Rg 0701 + VLSRX	0.65(LM)	200	C	0.50	0.85	0.90	0.65	0.60	0.50	0.75	0.75	19	10	20	Rg 0704 + VLSRX	0.80(L)	200	B	0.45	0.85	0.95	0.75	0.75	0.70	0.85	0.85	19	10	19	Rd 1522 + VLSRX	0.60	200	C	0.25	0.60	0.75	0.50	0.60	0.60	0.60	0.60	14	6	15	Rg 2516 + VLSRX	0.70	200	C	0.30	0.70	0.85	0.60	0.70	0.70	0.70	0.70	16	6	16
	EN ISO 354										EN ISO 10848-2	EN ISO 10140-2																																																																																																	
	$\alpha_w$	Cavity [mm]		Class	Frequency (Hz) $\alpha_p$						NRC	$D_{n,w}$ [dB]	$R_w$ [dB]	CAC [dB]																																																																																															
			125		250	500	1000	2000	4000																																																																																																				
Unperforated	0.10(L)	200	NC	0.40	0.20	0.10	0.10	0.10	0.10	0.15	0.15	34	19	35																																																																																															
Rg 0701 + VLSRX	0.65(LM)	200	C	0.50	0.85	0.90	0.65	0.60	0.50	0.75	0.75	19	10	20																																																																																															
Rg 0704 + VLSRX	0.80(L)	200	B	0.45	0.85	0.95	0.75	0.75	0.70	0.85	0.85	19	10	19																																																																																															
Rd 1522 + VLSRX	0.60	200	C	0.25	0.60	0.75	0.50	0.60	0.60	0.60	0.60	14	6	15																																																																																															
Rg 2516 + VLSRX	0.70	200	C	0.30	0.70	0.85	0.60	0.70	0.70	0.70	0.70	16	6	16																																																																																															
Fire reaction	Unperforated: <b>Euroclass A1</b> ; Rg 0701 / Rg 0704 with acoustic fleece VLSRX: <b>Euroclass A2-s1, d0</b> ; Rd 1522 / Rg 2516 with acoustic fleece VLSRX: <b>Euroclass A2-s2, d0</b> ; as per EN 13501-1																																																																																																												
Light reflectance	RAL 9010 unperforated: <b>85%</b> ; RAL 9010 Rd 1522: <b>66%</b> ; RAL 9010 Rg 0701: <b>83%</b> ; RAL 9010 Rg 2516: <b>73%</b> ; RAL 9010 Rg 0704: <b>82%</b>																																																																																																												
Humidity resistance	<b>90% RH</b>																																																																																																												
Indoor air quality	A+                      E1                      IAC Gold																																																																																																												
Sustainability	EN ISO 14021                      ISO 9001                      EN 15804                      CRADLE TO CRADLE SILVER 17.3% (2023)																																																																																																												
Cleanability																																																																																																													

# KNAUF

## METAL Q-Clip, Q-Clip F, R-Clip

*Concealed Grid*

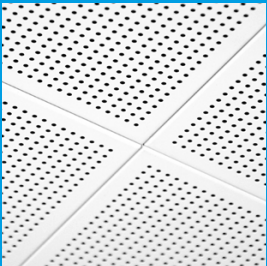

© Michael Van Oosten

**Build on us.**

- Clip-in tiles provide a versatile and sleek design in various perforations and edge details.
- Concealed grid for a monolithic effect.
- Additional design options available as part of our Vario Design range.
- Used in a variety of ceiling areas: from small to large commercial office buildings and major transportation terminals.

METAL Q-Clip

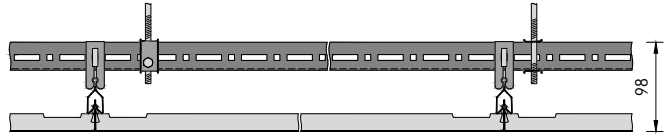
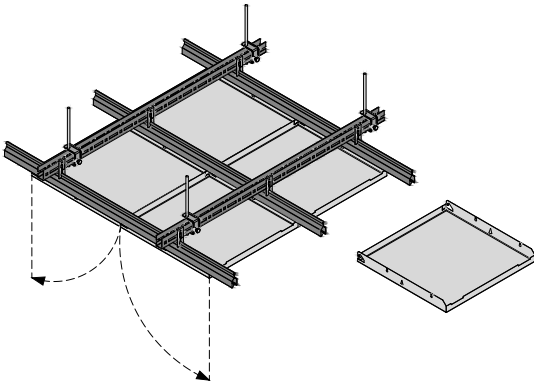

Tiles  
 Material post-coated galvanised steel 0.5 mm  
 Edge detail square edged clip-in  
 Modules 600 x 600, 625 x 625 mm

Suspension system  
 Standard U-Profile + DP12 A-Bar  
 Optional various, on request  
 Features swing-down function WINDOW  
 security clip  
 METAL K-Clip layout

METAL Q-Clip F

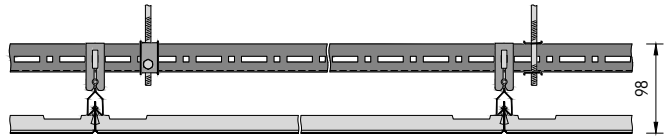
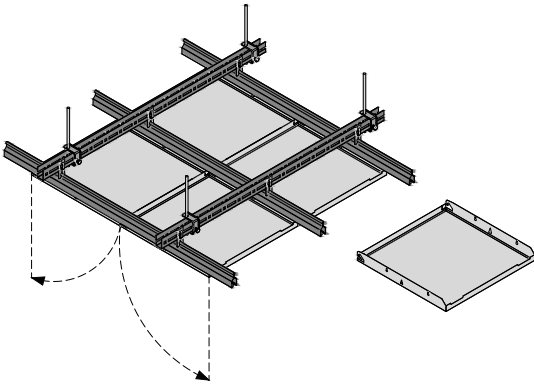

Tiles  
 Material post-coated galvanised steel 0.5 / 0.6 mm  
 Edge detail 3 mm bevel clip-in  
 Modules 600 x 600, 625 x 625, 1200 x 300,  
 1200 x 600, 1800 x 400 mm

Suspension system  
 Standard U-Profile + DP12 A-Bar  
 Optional various, on request  
 Features swing-down function WINDOW  
 security clip

METAL R-Clip

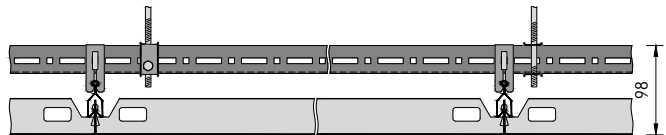
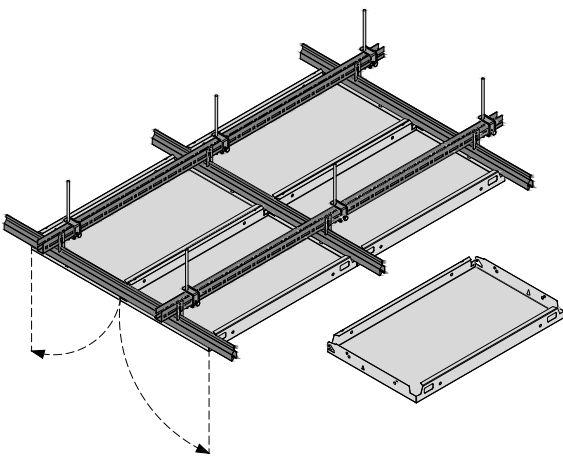

Tiles  
 Material post-coated galvanised steel 0.6 / 0.7 mm  
 Edge detail square edged clip-in  
 Dimensions length (A) 600 - 2500 mm / width (B) 250 - 600 mm  
 Panel size max. 1.5 m<sup>2</sup>

Suspension system  
 Standard U-Profile + DP12 A-Bar  
 Optional various, on request  
 Features swing-down function WINDOW  
 security clip  
 METAL K-Clip layout

METAL Q-Clip

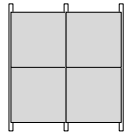
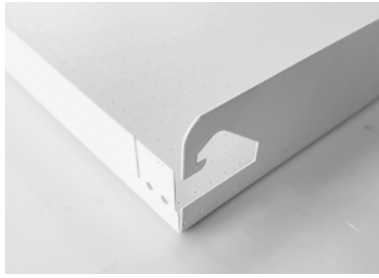
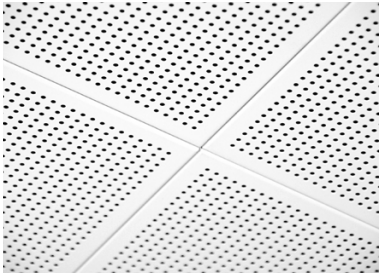

METAL Q-Clip F

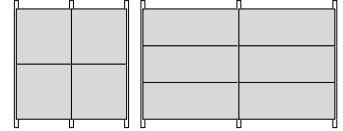
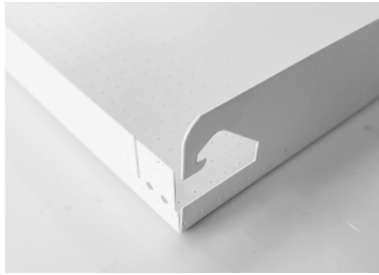
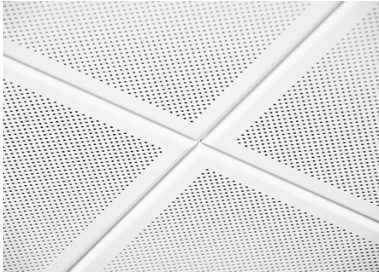

METAL R-Clip

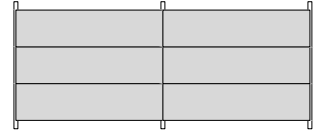
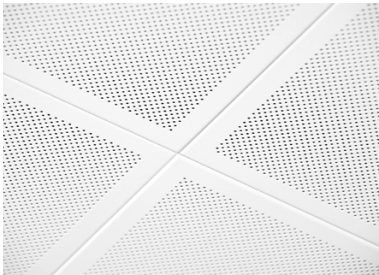

**Swing-down function WINDOW**



**Security clip option**



**METAL K-Clip layout option**

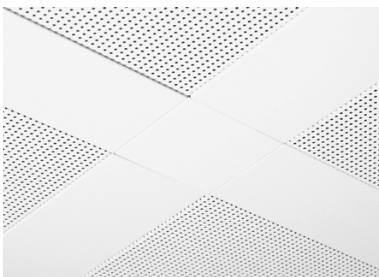

METAL Q-Clip tiles and METAL R-Clip panels can be combined with crossing boxes and strips to achieve a cost-effective tartan grid layout.

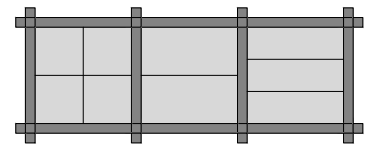

	VarioDesign options on request										Features & performances					
	Dimensions	Shapes	Post-coated aluminium	Perforations	RAL & NCS colours	BioGuard finish	Wood effect finish	Acoustic infills	Cut-outs	Grid alternatives	Secure function	Swing-down function	Clean room*	Seismic*	Impact resistance*	Suitable for chilled ceilings
<b>METAL Q-Clip</b>			■	■	■	■	■	■	■	■	■	■				■
<b>METAL Q-Clip F</b>	■		■	■	■	■	■	■	■	■	■	■				■
<b>METAL R-Clip</b>	■		■	■	■	■	■	■	■	■	■					■

\* see separate datasheet

Characteristic	Detailed information																																																																																																																			
Colour / Perforations	RAL 9016                      RAL 9010                      RAL 9006                      RAL 9007                      RAL 9005 further RAL & NCS colours on request	Unperforated                      Rg 0701                      Rg 0704                      Rd 1522                      Rg 2516 further options see acoustic datasheet																																																																																																																		
Acoustic infills	Black acoustic fleece VLSRX further options see acoustic datasheet																																																																																																																			
Weight	<b>3.8 - 6.6 kg/m<sup>2</sup></b> Weight varies depending on the perforation and acoustic infill.																																																																																																																			
Acoustics	<table border="1"> <thead> <tr> <th rowspan="3"></th> <th colspan="10">EN ISO 354</th> <th>EN ISO 10848-2</th> <th>EN ISO 10140-2</th> </tr> <tr> <th rowspan="2"><math>\alpha_w</math></th> <th rowspan="2">Cavity [mm]</th> <th rowspan="2">Class</th> <th colspan="6">Frequency (Hz) <math>\alpha_p</math></th> <th rowspan="2">NRC</th> <th rowspan="2"><math>D_{n,w}</math> [dB]</th> <th rowspan="2"><math>R_w</math> [dB]</th> <th rowspan="2">CAC [dB]</th> </tr> <tr> <th>125</th> <th>250</th> <th>500</th> <th>1000</th> <th>2000</th> <th>4000</th> </tr> </thead> <tbody> <tr> <td>Unperforated</td> <td>0.10(L)</td> <td>200</td> <td>NC</td> <td>0.40</td> <td>0.20</td> <td>0.10</td> <td>0.10</td> <td>0.10</td> <td>0.15</td> <td>0.15</td> <td>0.15</td> <td>34</td> <td>19</td> <td>35</td> </tr> <tr> <td>Rg 0701 + VLSRX</td> <td>0.65(LM)</td> <td>200</td> <td>C</td> <td>0.50</td> <td>0.85</td> <td>0.90</td> <td>0.65</td> <td>0.60</td> <td>0.50</td> <td>0.75</td> <td>0.75</td> <td>19</td> <td>10</td> <td>20</td> </tr> <tr> <td>Rg 0704 + VLSRX</td> <td>0.80(L)</td> <td>200</td> <td>B</td> <td>0.45</td> <td>0.85</td> <td>0.95</td> <td>0.75</td> <td>0.75</td> <td>0.70</td> <td>0.85</td> <td>19</td> <td>10</td> <td>19</td> </tr> <tr> <td>Rd 1522 + VLSRX</td> <td>0.60</td> <td>200</td> <td>C</td> <td>0.25</td> <td>0.60</td> <td>0.75</td> <td>0.50</td> <td>0.60</td> <td>0.60</td> <td>0.60</td> <td>14</td> <td>6</td> <td>15</td> </tr> <tr> <td>Rg 2516 + VLSRX</td> <td>0.70</td> <td>200</td> <td>C</td> <td>0.30</td> <td>0.70</td> <td>0.85</td> <td>0.60</td> <td>0.70</td> <td>0.70</td> <td>0.70</td> <td>16</td> <td>6</td> <td>16</td> </tr> </tbody> </table> <p><math>\alpha_w</math>: as per EN ISO 11654 / NRC: as per ASTM C 423-01 / <math>D_{n,w}</math>: as per EN ISO 717-1 / CAC: as per ASTM E 413-10</p>													EN ISO 354										EN ISO 10848-2	EN ISO 10140-2	$\alpha_w$	Cavity [mm]	Class	Frequency (Hz) $\alpha_p$						NRC	$D_{n,w}$ [dB]	$R_w$ [dB]	CAC [dB]	125	250	500	1000	2000	4000	Unperforated	0.10(L)	200	NC	0.40	0.20	0.10	0.10	0.10	0.15	0.15	0.15	34	19	35	Rg 0701 + VLSRX	0.65(LM)	200	C	0.50	0.85	0.90	0.65	0.60	0.50	0.75	0.75	19	10	20	Rg 0704 + VLSRX	0.80(L)	200	B	0.45	0.85	0.95	0.75	0.75	0.70	0.85	19	10	19	Rd 1522 + VLSRX	0.60	200	C	0.25	0.60	0.75	0.50	0.60	0.60	0.60	14	6	15	Rg 2516 + VLSRX	0.70	200	C	0.30	0.70	0.85	0.60	0.70	0.70	0.70	16	6	16
	EN ISO 354										EN ISO 10848-2	EN ISO 10140-2																																																																																																								
	$\alpha_w$	Cavity [mm]	Class	Frequency (Hz) $\alpha_p$						NRC	$D_{n,w}$ [dB]	$R_w$ [dB]		CAC [dB]																																																																																																						
				125	250	500	1000	2000	4000																																																																																																											
Unperforated	0.10(L)	200	NC	0.40	0.20	0.10	0.10	0.10	0.15	0.15	0.15	34	19	35																																																																																																						
Rg 0701 + VLSRX	0.65(LM)	200	C	0.50	0.85	0.90	0.65	0.60	0.50	0.75	0.75	19	10	20																																																																																																						
Rg 0704 + VLSRX	0.80(L)	200	B	0.45	0.85	0.95	0.75	0.75	0.70	0.85	19	10	19																																																																																																							
Rd 1522 + VLSRX	0.60	200	C	0.25	0.60	0.75	0.50	0.60	0.60	0.60	14	6	15																																																																																																							
Rg 2516 + VLSRX	0.70	200	C	0.30	0.70	0.85	0.60	0.70	0.70	0.70	16	6	16																																																																																																							
Fire reaction	Unperforated: <b>Euroclass A1</b> ; Rg 0701 / Rg 0704 with acoustic fleece VLSRX: <b>Euroclass A2-s1, d0</b> ; Rd 1522 / Rg 2516 with acoustic fleece VLSRX: <b>Euroclass A2-s2, d0</b> ; as per EN 13501-1																																																																																																																			
Light reflectance	RAL 9010 unperforated: <b>85%</b> ; RAL 9010 Rd 1522: <b>66%</b> ; RAL 9010 Rg 0701: <b>83%</b> ; RAL 9010 Rg 2516: <b>73%</b> ; RAL 9010 Rg 0704: <b>82%</b>																																																																																																																			
Humidity resistance	<b>90% RH</b>																																																																																																																			
Indoor air quality	A+    E1    IAC Gold																																																																																																																			
Sustainability	EN ISO 14021: 17.3% (2023) ISO 9001 / ISO 14001 EN 15804 cradle to cradle silver																																																																																																																			
Cleanability																																																																																																																				

# KNAUF

## METAL T-Clip F

Concealed Grid

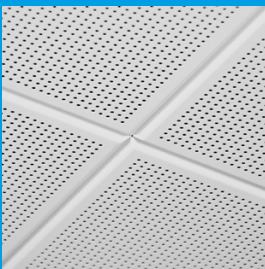

© Michael Van Oosten

**Build on us.**

- Clip-in tiles provide a versatile and sleek design in various perforations.
- Concealed grid for a monolithic effect.
- Additional design options available as part of our Vario Design range.
- Used in a variety of ceiling areas: from small to large commercial office buildings and major transportation terminals.

METAL T-Clip F

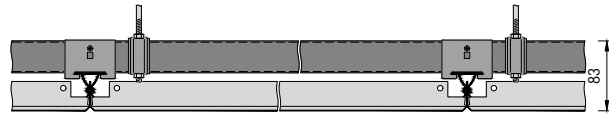
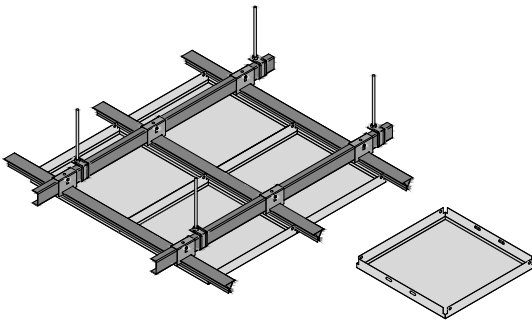

Tiles

Material post-coated galvanised steel 0.5 mm

Edge detail 5 mm bevel clip-in

Modules 600 x 600 mm

Suspension system

Standard C-Channel + Spring T

Optional U-Profile + Spring T

METAL T-Clip F

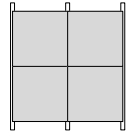
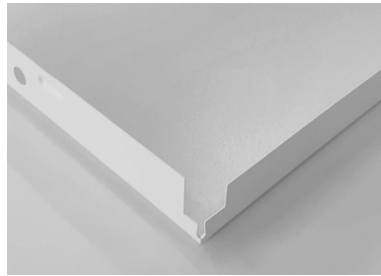
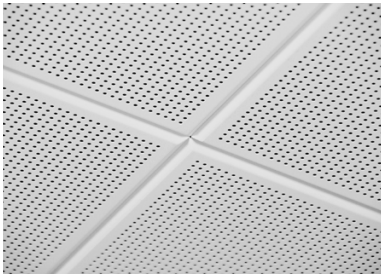

Security clip option

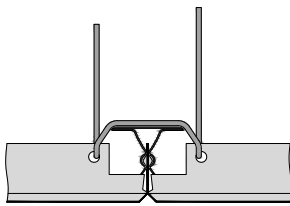

	VarioDesign options on request										Features & performances						
	Dimensions	Shapes	Post-coated aluminium	Perforations	RAL & NCS colours	BioGuard finish	Wood effect finish	Acoustic infills	Cut-outs	Grid alternatives	Secure function	Swing-down function	Clean room*	Seismic*	Impact resistance*	Suitable for chilled ceilings	Exterior*
<b>METAL T-Clip F</b>				■	■	■	■	■	■	■	■		■				

\* see separate datasheet

Characteristic	Detailed information																																																																																																																				
Colour / Perforations	RAL 9016                      RAL 9010                      RAL 9006                      RAL 9007                      RAL 9005 further RAL & NCS colours on request	Unperforated                      Rg 0701                      Rg 0704                      Rd 1522                      Rg 2516 further options see acoustic datasheet																																																																																																																			
Acoustic infills	Black acoustic fleece VLSRX further options see acoustic datasheet																																																																																																																				
Weight	<b>3.9 - 4.8 kg/m<sup>2</sup></b> Weight varies depending on the perforation and acoustic infill.																																																																																																																				
Acoustics	<table border="1"> <thead> <tr> <th rowspan="3"></th> <th colspan="10">EN ISO 354</th> <th>EN ISO 10848-2</th> <th>EN ISO 10140-2</th> <th rowspan="3">CAC [dB]</th> </tr> <tr> <th rowspan="2"><math>\alpha_w</math></th> <th rowspan="2">Cavity [mm]</th> <th rowspan="2">Class</th> <th colspan="6">Frequency (Hz) <math>\alpha_p</math></th> <th rowspan="2">NRC</th> <th rowspan="2"><math>D_{n,w}</math> [dB]</th> <th rowspan="2"><math>R_w</math> [dB]</th> </tr> <tr> <th>125</th> <th>250</th> <th>500</th> <th>1000</th> <th>2000</th> <th>4000</th> </tr> </thead> <tbody> <tr> <td>Unperforated</td> <td>0.10(L)</td> <td>200</td> <td>NC</td> <td>0.40</td> <td>0.20</td> <td>0.10</td> <td>0.10</td> <td>0.10</td> <td>0.10</td> <td>0.15</td> <td>0.15</td> <td>34</td> <td>19</td> <td>35</td> </tr> <tr> <td>Rg 0701 + VLSRX</td> <td>0.65(LM)</td> <td>200</td> <td>C</td> <td>0.50</td> <td>0.85</td> <td>0.90</td> <td>0.65</td> <td>0.60</td> <td>0.50</td> <td>0.75</td> <td>19</td> <td>10</td> <td>20</td> </tr> <tr> <td>Rg 0704 + VLSRX</td> <td>0.80(L)</td> <td>200</td> <td>B</td> <td>0.45</td> <td>0.85</td> <td>0.95</td> <td>0.75</td> <td>0.75</td> <td>0.70</td> <td>0.85</td> <td>19</td> <td>10</td> <td>19</td> </tr> <tr> <td>Rd 1522 + VLSRX</td> <td>0.60</td> <td>200</td> <td>C</td> <td>0.25</td> <td>0.60</td> <td>0.75</td> <td>0.50</td> <td>0.60</td> <td>0.60</td> <td>0.60</td> <td>14</td> <td>6</td> <td>15</td> </tr> <tr> <td>Rg 2516 + VLSRX</td> <td>0.70</td> <td>200</td> <td>C</td> <td>0.30</td> <td>0.70</td> <td>0.85</td> <td>0.60</td> <td>0.70</td> <td>0.70</td> <td>0.70</td> <td>16</td> <td>6</td> <td>16</td> </tr> </tbody> </table> <p><math>\alpha_w</math>: as per EN ISO 11654 / NRC: as per ASTM C 423-01 / <math>D_{n,w}</math>: as per EN ISO 717-1 / CAC: as per ASTM E 413-10</p>															EN ISO 354										EN ISO 10848-2	EN ISO 10140-2	CAC [dB]	$\alpha_w$	Cavity [mm]	Class	Frequency (Hz) $\alpha_p$						NRC	$D_{n,w}$ [dB]	$R_w$ [dB]	125	250	500	1000	2000	4000	Unperforated	0.10(L)	200	NC	0.40	0.20	0.10	0.10	0.10	0.10	0.15	0.15	34	19	35	Rg 0701 + VLSRX	0.65(LM)	200	C	0.50	0.85	0.90	0.65	0.60	0.50	0.75	19	10	20	Rg 0704 + VLSRX	0.80(L)	200	B	0.45	0.85	0.95	0.75	0.75	0.70	0.85	19	10	19	Rd 1522 + VLSRX	0.60	200	C	0.25	0.60	0.75	0.50	0.60	0.60	0.60	14	6	15	Rg 2516 + VLSRX	0.70	200	C	0.30	0.70	0.85	0.60	0.70	0.70	0.70	16	6	16
	EN ISO 354										EN ISO 10848-2	EN ISO 10140-2	CAC [dB]																																																																																																								
	$\alpha_w$	Cavity [mm]	Class	Frequency (Hz) $\alpha_p$						NRC	$D_{n,w}$ [dB]	$R_w$ [dB]																																																																																																									
				125	250	500	1000	2000	4000																																																																																																												
Unperforated	0.10(L)	200	NC	0.40	0.20	0.10	0.10	0.10	0.10	0.15	0.15	34	19	35																																																																																																							
Rg 0701 + VLSRX	0.65(LM)	200	C	0.50	0.85	0.90	0.65	0.60	0.50	0.75	19	10	20																																																																																																								
Rg 0704 + VLSRX	0.80(L)	200	B	0.45	0.85	0.95	0.75	0.75	0.70	0.85	19	10	19																																																																																																								
Rd 1522 + VLSRX	0.60	200	C	0.25	0.60	0.75	0.50	0.60	0.60	0.60	14	6	15																																																																																																								
Rg 2516 + VLSRX	0.70	200	C	0.30	0.70	0.85	0.60	0.70	0.70	0.70	16	6	16																																																																																																								
Fire reaction	Unperforated: <b>Euroclass A1</b> ; Rg 0701 / Rg 0704 with acoustic fleece VLSRX: <b>Euroclass A2-s1, d0</b> ; Rd 1522 / Rg 2516 with acoustic fleece VLSRX: <b>Euroclass A2-s2, d0</b> ; as per EN 13501-1																																																																																																																				
Light reflectance	RAL 9010 unperforated: <b>85%</b> ; RAL 9010 Rd 1522: <b>66%</b> ; RAL 9010 Rg 0701: <b>83%</b> ; RAL 9010 Rg 2516: <b>73%</b> ; RAL 9010 Rg 0704: <b>82%</b>																																																																																																																				
Humidity resistance	<b>90% RH</b>																																																																																																																				
Indoor air quality	A+                      E1                      IAC Gold																																																																																																																				
Sustainability	EN ISO 14021                      ISO 9001 / ISO 14001                      EN 15804                      Cradle to cradle Silver 17.3% (2023)																																																																																																																				
Cleanability																																																																																																																					

# KNAUF

## METAL R-H 200, Q-H 100 F, R-H 215

*Concealed Grid*

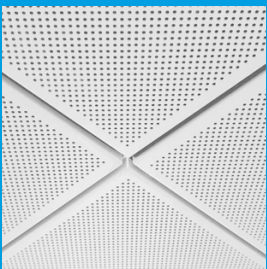

© Stefan Zürcher



- Hook-on panels provide a versatile and simple design with excellent acoustic performance benefits.
- Concealed grid for a monolithic effect.
- Fully configurable large size panels and cost effective square tile alternatives available.
- Additional design options available as part of our Vario Design range.
- Used in a variety of ceiling areas: from small service rooms to large commercial office buildings and major transportation terminals.

**Build on us.**

METAL R-H 200

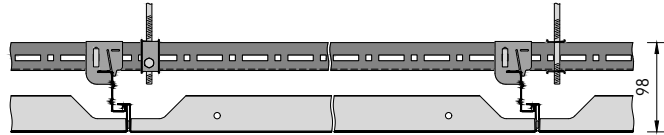
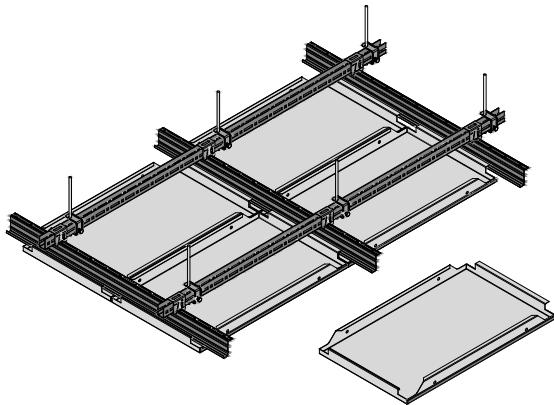

Tiles  
 Material post-coated galvanised steel 0.6 / 0.7 mm  
 Edge detail square edged hook-on, with 3 mm gasket on long and short edge  
 Dimensions length (A) 600 - 3300 mm / width (B) 247 - 1350 mm  
 Panel size max. 2 m<sup>2</sup>

Suspension system  
 Standard U-Profile + J-Bar  
 Optional various, on request  
 Features security clip  
 perimeter panels, long side suspended panels for staggered layouts  
 bespoke and radial layout with trapezoidal panels  
 curved ceiling layouts with curved panels

METAL Q-H 100 F

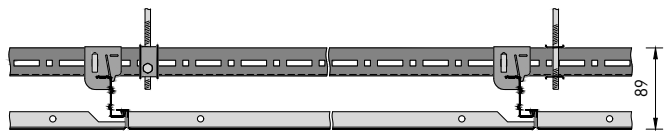
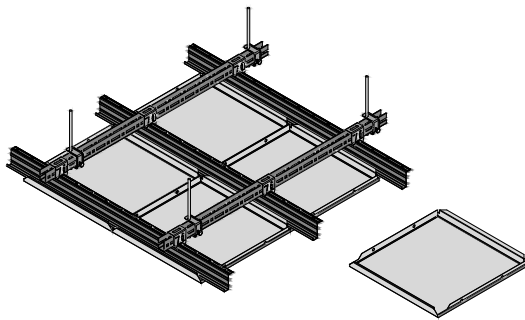

Tiles  
 Material post-coated galvanised steel 0.5 mm  
 Edge detail 2 mm bevel hook-on, with 2 mm gasket on long and short edge  
 Modules 600 x 600, 625 x 625 mm

Suspension system  
 Standard U-Profile + J-Bar  
 Optional various, on request  
 Features security bracket

METAL R-H 215

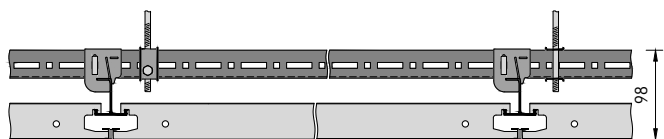
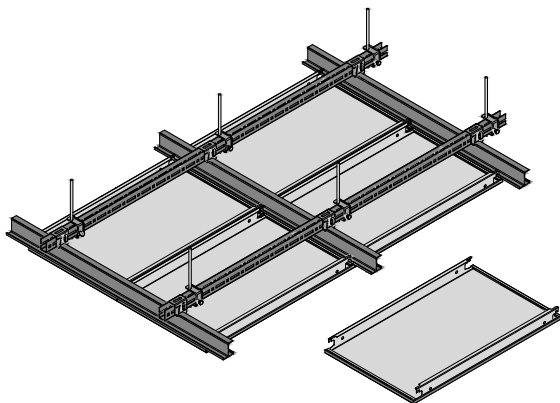

Tiles  
 Material post-coated galvanised steel 0.6 / 0.7 mm  
 Edge detail square edged hook-on, with 3 mm gasket on long and short edge  
 Dimensions length (A) 600 - 3300 mm / width (B) 247 - 1350 mm  
 Panel size max. 2 m<sup>2</sup>

Suspension system  
 Standard U-Profile + H-Profile 35  
 Features security clip  
 perimeter panels  
 curved ceiling layouts with segmented panels

METAL R-H 200

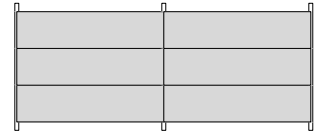
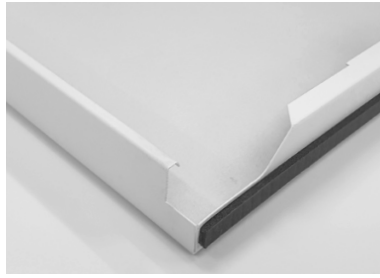
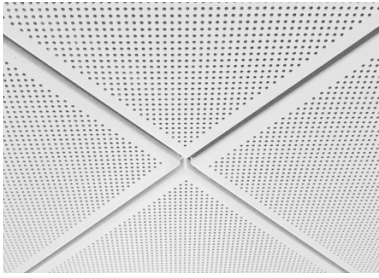

METAL Q-H 100 F

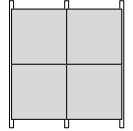
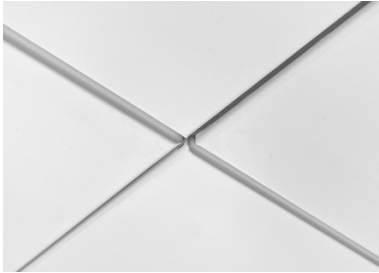

METAL R-H 215

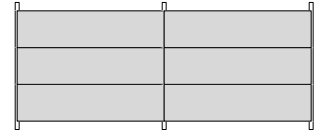
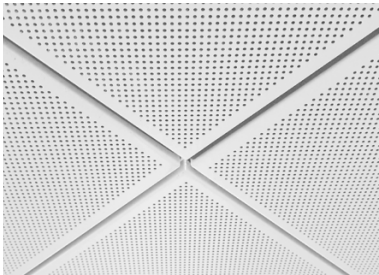

**Security clip options**

For METAL R-H 200



For METAL R-H 215

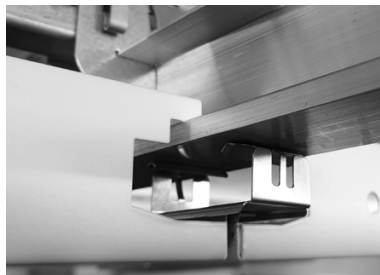

With both solutions it is possible to extract a panel from the fully installed ceiling. An extraction tool is required for this.

**Service access opening option**

For METAL R-H 215



This solution is intended for individual panels, but can also be used for the entire ceiling surface and is only intended as an service access opening, without additional weights in the panels.

	VarioDesign options on request										Features & performances						
	Dimensions	Shapes	Post-coated aluminium	Perforations	RAL & NCS colours	BioGuard finish	Wood effect finish	Acoustic infills	Cut-outs	Grid alternatives	Secure function	Swing-down function	Clean room*	Seismic*	Impact resistance*	Suitable for chilled ceilings	Exterior*
<b>METAL R-H 200</b>	■	■	■	■	■	■	■	■	■	■	■			■	■	■	
<b>METAL Q-H 100 F</b>			■	■	■	■	■	■	■	■	■						
<b>METAL R-H 215</b>	■	■	■	■	■	■	■	■	■		■	■					

\* see separate datasheet

Characteristic	Detailed information													
Colour / Perforations	RAL 9016                      RAL 9010                      RAL 9006                      RAL 9007                      RAL 9005 further RAL & NCS colours on request	Unperforated                      Rg 0701                      Rg 0704                      Rd 1522                      Rg 2516 further options see acoustic datasheet												
Acoustic infills	Black acoustic fleece VLSRX further options see acoustic datasheet													
Weight	<b>3.8 – 6.7 kg/m<sup>2</sup></b> Weight varies depending on the perforation and acoustic infill.													
Acoustics	EN ISO 354 Frequency (Hz) $\alpha_w$												EN ISO 10848-2	EN ISO 10140-2
	$\alpha_w$	Cavity [mm]	Class	125	250	500	1000	2000	4000	NRC	$D_{n,w}$ [dB]	$R_w$ [dB]	CAC [dB]	
	Unperforated	0.10(L)	200	NC	0.40	0.20	0.10	0.10	0.10	0.15	0.15	34	19	35
	Rg 0701 + VLSRX	0.65(LM)	200	C	0.50	0.85	0.90	0.65	0.60	0.50	0.75	19	10	20
	Rg 0704 + VLSRX	0.80(L)	200	B	0.45	0.85	0.95	0.75	0.75	0.70	0.85	19	10	19
	Rd 1522 + VLSRX	0.60	200	C	0.25	0.60	0.75	0.50	0.60	0.60	0.60	14	6	15
	Rg 2516 + VLSRX	0.70	200	C	0.30	0.70	0.85	0.60	0.70	0.70	0.70	16	6	16
	$\alpha_w$ : as per EN ISO 11654 / NRC: as per ASTM C 423-01 / $D_{n,w}$ : as per EN ISO 717-1 / CAC: as per ASTM E 413-10													
Fire reaction	Unperforated: <b>Euroclass A1</b> ; Rg 0701 / Rg 0704 with acoustic fleece VLSRX: <b>Euroclass A2-s1, d0</b> ; Rd 1522 / Rg 2516 with acoustic fleece VLSRX: <b>Euroclass A2-s2, d0</b> ; as per EN 13501-1													
Light reflectance	RAL 9010 unperforated: <b>85%</b> ;				RAL 9010 Rg 0701: <b>83%</b> ;				RAL 9010 Rg 0704: <b>82%</b> ;					
	RAL 9010 Rd 1522: <b>66%</b> ;				RAL 9010 Rg 2516: <b>73%</b>									
Humidity resistance	<b>90% RH</b>													
Indoor air quality	A+                      E1                      IAC Gold													
Sustainability/ Cleanability	EN ISO 14001                      ISO 9001                      EPD EN 15804                      cradle to cradle SILVER													
	17.3% (2023)													

# KNAUF

## **METAL** **R-H 220,** **Q-H 120 F** *Concealed Grid*

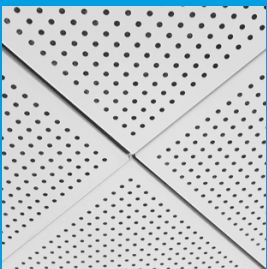

© Stefan Zürcher

- Hook-on panels provide a versatile and simple design with excellent acoustic performance benefits.
- Concealed grid for a monolithic effect.
- Fully configurable large size panels and cost effective square tile alternatives available.
- Additional design options available as part of our Vario Design range.
- Used in a variety of ceiling areas: from small service rooms to large commercial office buildings and major transportation terminals.

## **Build on us.**

METAL R-H 220

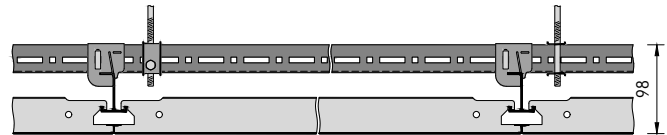
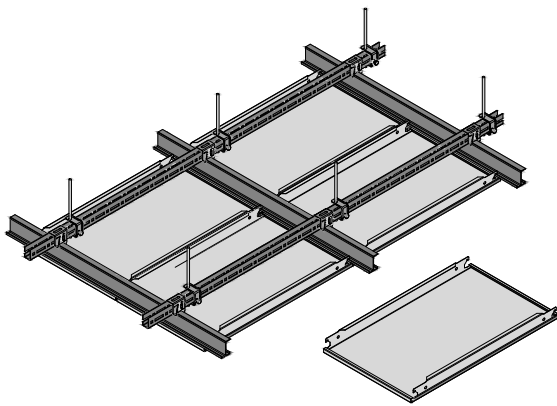

Tiles  
 Material post-coated galvanised steel 0.6 / 0.7 mm  
 Edge detail square edged hook-on, with 3 mm gasket on long edge  
 Dimensions length (A) 600 - 3300 mm / width (B) 247 - 1350 mm  
 Panel size max. 2 m<sup>2</sup>

Suspension system  
 Standard U-Profile + H-Profile 28  
 Features security clip  
 perimeter panels

METAL Q-H 120 F

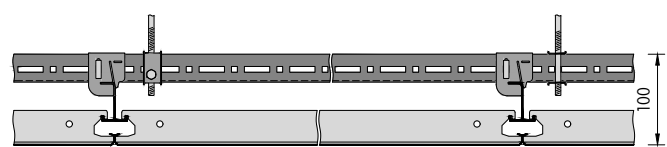
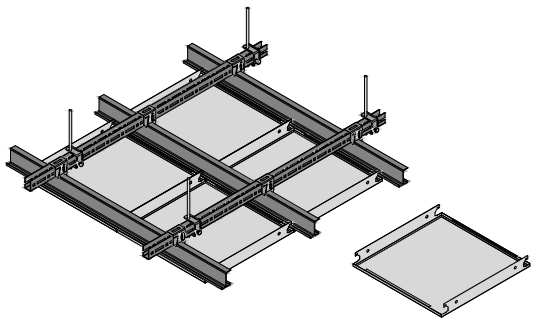

Tiles  
 Material post-coated galvanised steel 0.5 mm  
 Edge detail 3 mm bevel hook-on  
 Modules 625 x 625 mm

Suspension system  
 Standard U-Profile + H-Profile 28



© Stefan Zürrer

METAL R-H 220

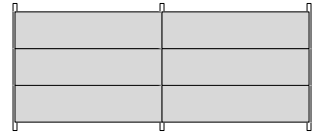
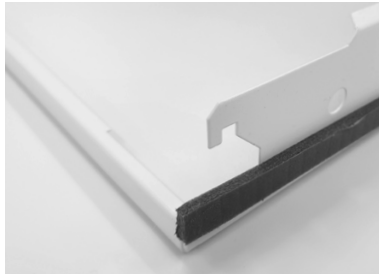
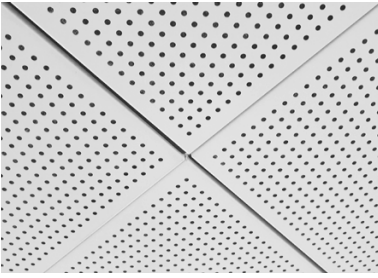

METAL Q-H 120 F

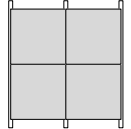
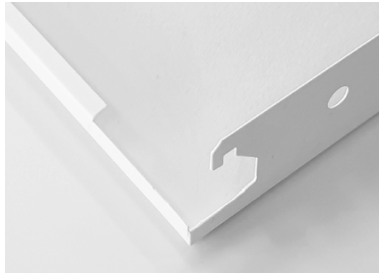
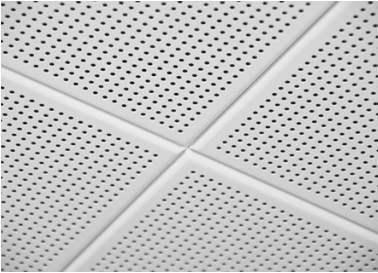

**Security clip option**

For METAL R-H 220

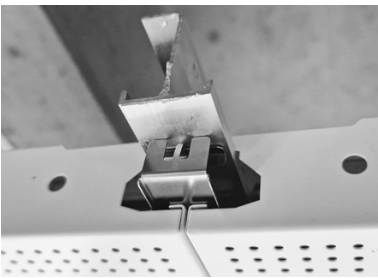

With this solution it is possible to extract a panel from the fully installed ceiling. An extraction tool is required for this.

	VarioDesign options on request										Features & performances						
	Dimensions	Shapes	Post-coated aluminium	Perforations	RAL & NCS colours	BioGuard finish	Wood effect finish	Acoustic infills	Cut-outs	Grid alternatives	Secure function	Swing-down function	Clean room*	Seismic*	Impact resistance*	Suitable for chilled ceilings	Exterior*
<b>METAL R-H 220</b>	■		■	■	■	■	■	■	■		■						
<b>METAL Q-H 120 F</b>			■	■	■	■	■	■	■								

\* see separate datasheet

Characteristic	Detailed information																																																																																																																						
Colour / Perforations	RAL 9016                      RAL 9010                      RAL 9006                      RAL 9007                      RAL 9005 further RAL & NCS colours on request	Unperforated                      Rg 0701                      Rg 0704                      Rd 1522                      Rg 2516 further options see acoustic datasheet																																																																																																																					
Acoustic infills	Black acoustic fleece VLSRX further options see acoustic datasheet																																																																																																																						
Weight	<b>3.7 - 6.9 kg/m<sup>2</sup></b> Weight varies depending on the perforation and acoustic infill.																																																																																																																						
Acoustics	<table border="1"> <thead> <tr> <th rowspan="3"></th> <th colspan="10">EN ISO 354</th> <th>EN ISO 10848-2</th> <th>EN ISO 10140-2</th> <th rowspan="3">CAC [dB]</th> </tr> <tr> <th rowspan="2"><math>\alpha_w</math></th> <th rowspan="2">Cavity [mm]</th> <th rowspan="2">Class</th> <th colspan="6">Frequency (Hz) <math>\alpha_w</math></th> <th rowspan="2">NRC</th> <th rowspan="2"><math>D_{n,w}</math> [dB]</th> <th rowspan="2"><math>R_w</math> [dB]</th> </tr> <tr> <th>125</th> <th>250</th> <th>500</th> <th>1000</th> <th>2000</th> <th>4000</th> </tr> </thead> <tbody> <tr> <td>Unperforated</td> <td>0.10(L)</td> <td>200</td> <td>NC</td> <td>0.40</td> <td>0.20</td> <td>0.10</td> <td>0.10</td> <td>0.10</td> <td>0.10</td> <td>0.15</td> <td>0.15</td> <td>34</td> <td>19</td> <td>35</td> </tr> <tr> <td>Rg 0701 + VLSRX</td> <td>0.65(LM)</td> <td>200</td> <td>C</td> <td>0.50</td> <td>0.85</td> <td>0.90</td> <td>0.65</td> <td>0.60</td> <td>0.50</td> <td>0.75</td> <td>0.75</td> <td>19</td> <td>10</td> <td>20</td> </tr> <tr> <td>Rg 0704 + VLSRX</td> <td>0.80(L)</td> <td>200</td> <td>B</td> <td>0.45</td> <td>0.85</td> <td>0.95</td> <td>0.75</td> <td>0.75</td> <td>0.70</td> <td>0.85</td> <td>0.85</td> <td>19</td> <td>10</td> <td>19</td> </tr> <tr> <td>Rd 1522 + VLSRX</td> <td>0.60</td> <td>200</td> <td>C</td> <td>0.25</td> <td>0.60</td> <td>0.75</td> <td>0.50</td> <td>0.60</td> <td>0.60</td> <td>0.60</td> <td>0.60</td> <td>14</td> <td>6</td> <td>15</td> </tr> <tr> <td>Rg 2516 + VLSRX</td> <td>0.70</td> <td>200</td> <td>C</td> <td>0.30</td> <td>0.70</td> <td>0.85</td> <td>0.60</td> <td>0.70</td> <td>0.70</td> <td>0.70</td> <td>0.70</td> <td>16</td> <td>6</td> <td>16</td> </tr> </tbody> </table> <p><math>\alpha_w</math>: as per EN ISO 11654 / NRC: as per ASTM C 423-01 / <math>D_{n,w}</math>: as per EN ISO 717-1 / CAC: as per ASTM E 413-10</p>													EN ISO 354										EN ISO 10848-2	EN ISO 10140-2	CAC [dB]	$\alpha_w$	Cavity [mm]	Class	Frequency (Hz) $\alpha_w$						NRC	$D_{n,w}$ [dB]	$R_w$ [dB]	125	250	500	1000	2000	4000	Unperforated	0.10(L)	200	NC	0.40	0.20	0.10	0.10	0.10	0.10	0.15	0.15	34	19	35	Rg 0701 + VLSRX	0.65(LM)	200	C	0.50	0.85	0.90	0.65	0.60	0.50	0.75	0.75	19	10	20	Rg 0704 + VLSRX	0.80(L)	200	B	0.45	0.85	0.95	0.75	0.75	0.70	0.85	0.85	19	10	19	Rd 1522 + VLSRX	0.60	200	C	0.25	0.60	0.75	0.50	0.60	0.60	0.60	0.60	14	6	15	Rg 2516 + VLSRX	0.70	200	C	0.30	0.70	0.85	0.60	0.70	0.70	0.70	0.70	16	6	16
	EN ISO 354										EN ISO 10848-2	EN ISO 10140-2		CAC [dB]																																																																																																									
	$\alpha_w$	Cavity [mm]	Class	Frequency (Hz) $\alpha_w$						NRC	$D_{n,w}$ [dB]	$R_w$ [dB]																																																																																																											
				125	250	500	1000	2000	4000																																																																																																														
Unperforated	0.10(L)	200	NC	0.40	0.20	0.10	0.10	0.10	0.10	0.15	0.15	34	19	35																																																																																																									
Rg 0701 + VLSRX	0.65(LM)	200	C	0.50	0.85	0.90	0.65	0.60	0.50	0.75	0.75	19	10	20																																																																																																									
Rg 0704 + VLSRX	0.80(L)	200	B	0.45	0.85	0.95	0.75	0.75	0.70	0.85	0.85	19	10	19																																																																																																									
Rd 1522 + VLSRX	0.60	200	C	0.25	0.60	0.75	0.50	0.60	0.60	0.60	0.60	14	6	15																																																																																																									
Rg 2516 + VLSRX	0.70	200	C	0.30	0.70	0.85	0.60	0.70	0.70	0.70	0.70	16	6	16																																																																																																									
Fire reaction	Unperforated: <b>Euroclass A1</b> ; Rg 0701 / Rg 0704 with acoustic fleece VLSRX: <b>Euroclass A2-s1, d0</b> ; Rd 1522 / Rg 2516 with acoustic fleece VLSRX: <b>Euroclass A2-s2, d0</b> ; as per EN 13501-1																																																																																																																						
Light reflectance	RAL 9010 unperforated: <b>85%</b> ; RAL 9010 Rd 1522: <b>66%</b> ; RAL 9010 Rg 0701: <b>83%</b> ; RAL 9010 Rg 2516: <b>73%</b> ; RAL 9010 Rg 0704: <b>82%</b>																																																																																																																						
Humidity resistance	<b>90% RH</b>																																																																																																																						
Indoor air quality	A+                      E1                      IAC Gold																																																																																																																						
Sustainability	EN ISO 14021                      ISO 9001                      EN 15804                      cradle to cradle silver 17.3% (2023)																																																																																																																						
Cleanability																																																																																																																							

# KNAUF

## METAL Grille Cellio

Grille - Open cell



© Sandro Lendler

**Build on us.**

- Durable grille elements that mask the plenum and provide 100% accessibility to lighting, ventilation and sprinklers with an homogeneous appearance.
- Lay-In system is fast and easy to install in standard 15 mm exposed grid.
- Ideal for shops, supermarkets, shopping malls, entrance areas, airports, railway stations and showrooms.

METAL Grille Cellio

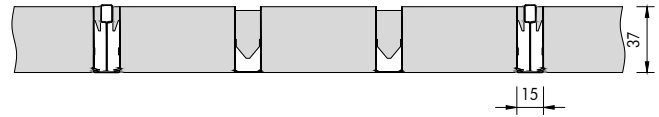
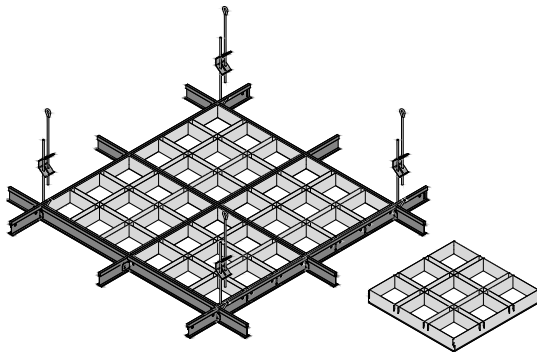

Tiles  
 Material pre-coated galvanised steel 0.3 mm  
 Edge detail square edged lay-in  
 Modules 600 x 600 mm

Suspension system  
 Standard 15 mm T-grid, butt-cut (System C)

C64

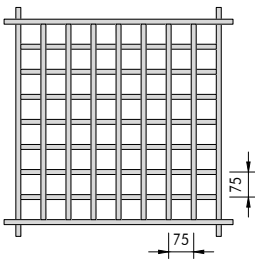

C49

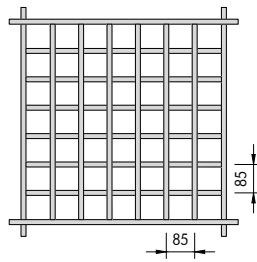

C36

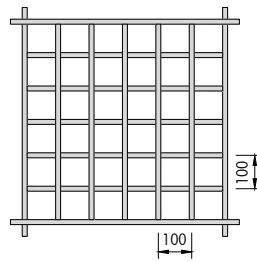

C25

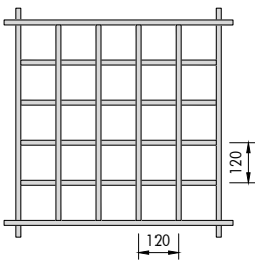

C16

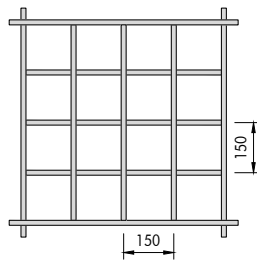

C9

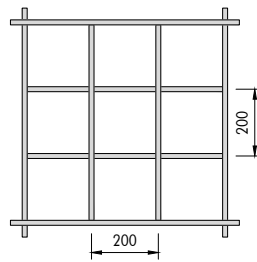

G8

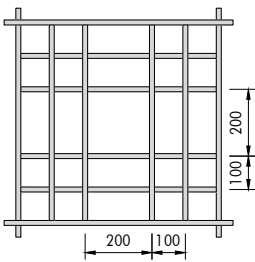

G10

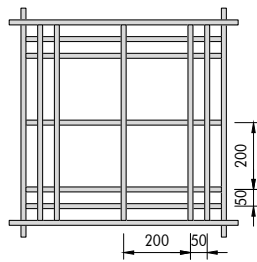



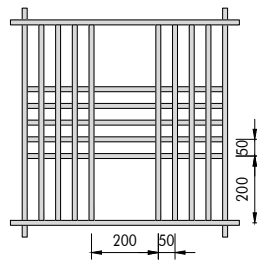



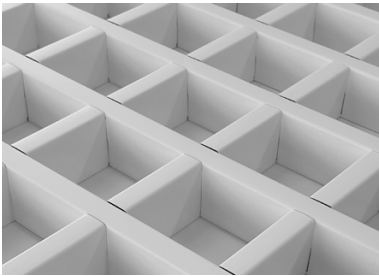
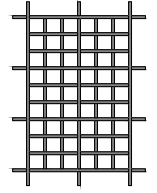





G13



METAL Grille Cellio



© Szymon Polański

Characteristic	Detailed information	
Colour / Perforations 	  	white (similar to RAL 9003)
Weight 	<b>2.2 - 5.9 kg/m<sup>2</sup></b>	
Fire reaction 	<b>Euroclass A1;</b> as per EN 13501-1	
Humidity resistance 	<b>90% RH</b>	
Indoor air quality 		A+
Sustainability 	17.3% (2023)	
Cleanability   		

## **METAL** *Sonic Element, Sky Element Clip, Sky Element Hook* *Floating Ceilings - Canopies*



© Bernd Gallandi

- METAL Sonic Element is a fully configurable solution, available with different edge details, suspended as a single element with adjustable hanging wires for a quick and easy installation.
- An optional rear cover with perforation allows for better sound absorption and 360° visibility.
- METAL Sky Element Clip and METAL Sky Element Hook systems are floating modular solutions for optimum flexibility.
- Fully configurable large size panels, installed in a row, with standard and end panels or as single elements.
- Additional design options available as part of our Vario Design range.
- Ideal for showrooms, entrance halls, transport hubs, meeting rooms, retail and waiting areas.

**Build on us.**

# METAL Sonic Element, Sky Element Clip, Sky Element Hook

## METAL Sonic Element

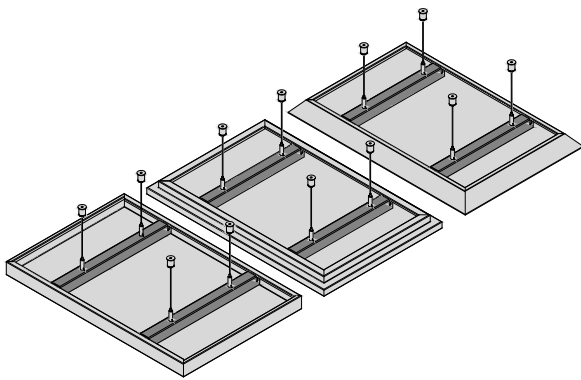

90° edge option



20 x 20 mm edge option

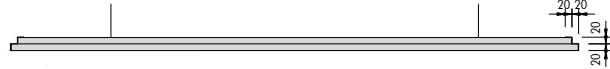

50° edge option



**Canopies**

**Material** post-coated galvanised steel 0.7 mm  
**Edge detail** 90°, 20 x 20 mm, 50° option, delivered with two reinforcement profiles inside  
**Dimensions** length (A) 600 - 1800 mm / width (B) 600 - 1200 mm  
**Canopy size** max. 2.16 m<sup>2</sup>

**Suspension system**

**Standard** hanging wire (4000 mm length), 4 pcs/canopy needed  
**Features** Rg 2516 perforated rear cover for 360° visibility curved elements

## METAL Sky Element Clip

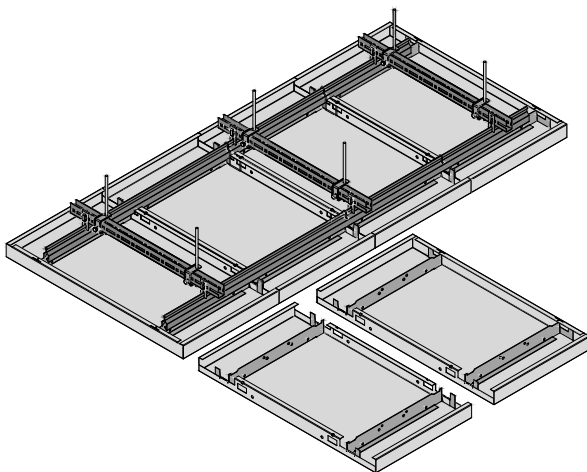

90° edge option

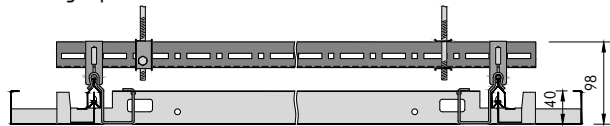

**Panels**

**Material** post-coated galvanised steel 0.6 / 0.7 mm  
**Edge detail** square edged clip-in standard panels with visible short sides  
 square edged clip-in end panels with one visible long and short sides  
**Dimensions** length (A) 600 - 2500 mm / width (B) 250 - 600 mm  
**Panel size** max. 1.5 m<sup>2</sup>

**Suspension system**

**Standard** U-Profile + DP12 A-Bar  
**Features** swing-down function ACCESS for standard panels security clip

## METAL Sky Element Hook

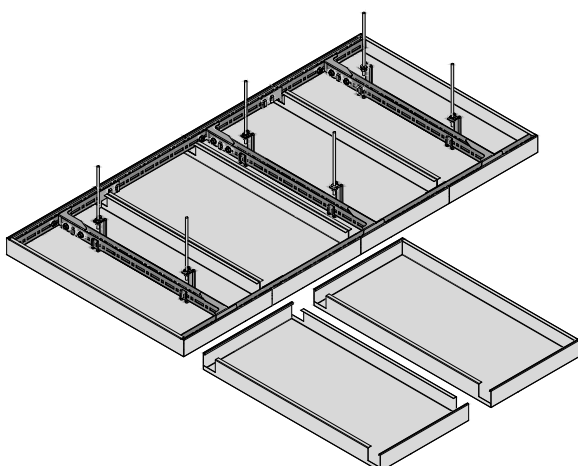

90° edge option

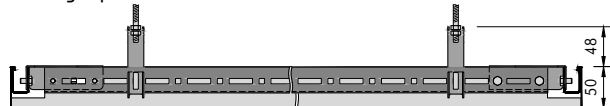

**Panels**

**Material** post-coated galvanised steel 0.6 / 0.7 mm  
**Edge detail** square edged hook-on standard panels with visible short sides  
 square edged hook-on end panels with one visible long and short sides  
**Dimensions** length (A) 600 - 2750 mm (in steps of 25 mm)  
 width (B) 250 - 600 mm (in steps of 25 mm)  
**Panel size** max. 1.65 m<sup>2</sup>

**Suspension system**

**Standard** U-Profile cross-connected, for a slim design with concealed grid  
**Features** 65 mm panel height for chilled ceilings and acoustic pads

# METAL Sonic Element, Sky Element Clip, Sky Element Hook

METAL Sonic Element

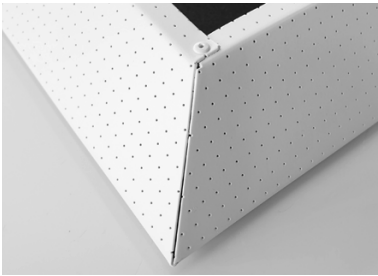
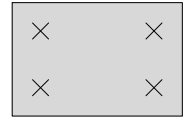

METAL Sky Element Clip

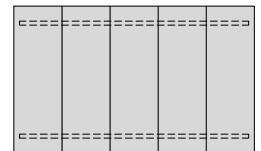
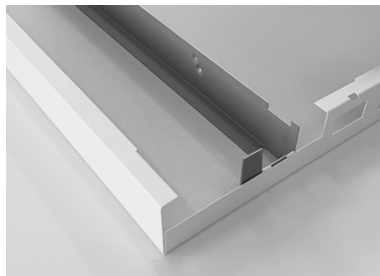

METAL Sky Element Hook

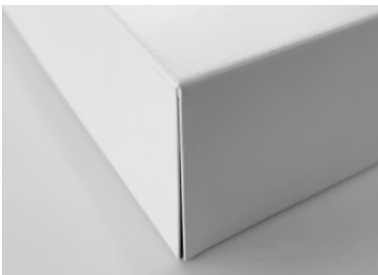

**Security clip option**  
For METAL Sky Element Clip



**Swing-down function Access**  
For METAL Sky Element Clip  
standard panels



	VarioDesign options on request										Features & performances					
	Dimensions	Shapes	Post-coated aluminium	Perforations	RAL & NCS colours	BioGuard finish	Wood effect finish	Acoustic infills	Cut-outs	Grid alternatives	Secure function	Swing-down function	Clean room*	Seismic*	Impact resistance*	Suitable for chilled ceilings
<b>METAL Sonic Element</b>	■	■	■	■	■	■	■	■	■							
<b>METAL Sky Element Clip</b>	■		■	■	■	■	■	■	■		■					
<b>METAL Sky Element Hook</b>	■		■	■	■	■	■	■	■						■	

\* see separate datasheet

Characteristic	Detailed information																																																																																																																																																																																																																			
Colour / Perforations	RAL 9016                      RAL 9010                      RAL 9006                      RAL 9007                      RAL 9005 further RAL & NCS colours on request	Unperforated                      Rg 0701                      Rg 0704                      Rd 1522                      Rg 2516 further options see acoustic datasheet																																																																																																																																																																																																																		
Acoustic infills	Black acoustic fleece VLSRX further options see acoustic datasheet																																																																																																																																																																																																																			
Weight	<b>3.9 – 26 kg/m<sup>2</sup></b> Weight varies depending on the perforation and acoustic infill.																																																																																																																																																																																																																			
Acoustics	<b>Values for multipanel canopies: METAL Sky Element Clip, METAL Sky Element Hook</b>																																																																																																																																																																																																																			
	<table border="1"> <thead> <tr> <th rowspan="3"></th> <th colspan="10">EN ISO 354</th> </tr> <tr> <th rowspan="2">α<sub>w</sub></th> <th rowspan="2">Cavity [mm]</th> <th rowspan="2">Class</th> <th colspan="6">Frequency (Hz) α<sub>p</sub></th> <th rowspan="2">NRC</th> </tr> <tr> <th>125</th> <th>250</th> <th>500</th> <th>1000</th> <th>2000</th> <th>4000</th> </tr> </thead> <tbody> <tr> <td>Unperforated</td> <td>0.10(L)</td> <td>200</td> <td>NC</td> <td>0.40</td> <td>0.20</td> <td>0.10</td> <td>0.10</td> <td>0.10</td> <td>0.15</td> <td>0.15</td> </tr> <tr> <td>Rg 0701 + VLSRX</td> <td>0.65(LM)</td> <td>200</td> <td>C</td> <td>0.50</td> <td>0.85</td> <td>0.90</td> <td>0.65</td> <td>0.60</td> <td>0.50</td> <td>0.75</td> </tr> <tr> <td>Rg 0704 + VLSRX</td> <td>0.80(L)</td> <td>200</td> <td>B</td> <td>0.45</td> <td>0.85</td> <td>0.95</td> <td>0.75</td> <td>0.75</td> <td>0.70</td> <td>0.85</td> </tr> <tr> <td>Rd 1522 + VLSRX</td> <td>0.60</td> <td>200</td> <td>C</td> <td>0.25</td> <td>0.60</td> <td>0.75</td> <td>0.50</td> <td>0.60</td> <td>0.60</td> <td>0.60</td> </tr> <tr> <td>Rg 2516 + VLSRX</td> <td>0.70</td> <td>200</td> <td>C</td> <td>0.30</td> <td>0.70</td> <td>0.85</td> <td>0.60</td> <td>0.70</td> <td>0.70</td> <td>0.70</td> </tr> </tbody> </table> <p>α<sub>w</sub>: as per EN ISO 11654 / NRC: as per ASTM C 423-01 / Dn.f.w: as per EN ISO 717-1 / CAC: as per ASTM E 413-10</p>			EN ISO 354										α <sub>w</sub>	Cavity [mm]	Class	Frequency (Hz) α <sub>p</sub>						NRC	125	250	500	1000	2000	4000	Unperforated	0.10(L)	200	NC	0.40	0.20	0.10	0.10	0.10	0.15	0.15	Rg 0701 + VLSRX	0.65(LM)	200	C	0.50	0.85	0.90	0.65	0.60	0.50	0.75	Rg 0704 + VLSRX	0.80(L)	200	B	0.45	0.85	0.95	0.75	0.75	0.70	0.85	Rd 1522 + VLSRX	0.60	200	C	0.25	0.60	0.75	0.50	0.60	0.60	0.60	Rg 2516 + VLSRX	0.70	200	C	0.30	0.70	0.85	0.60	0.70	0.70	0.70																																																																																																																																
	EN ISO 354																																																																																																																																																																																																																			
	α <sub>w</sub>	Cavity [mm]		Class	Frequency (Hz) α <sub>p</sub>						NRC																																																																																																																																																																																																									
			125		250	500	1000	2000	4000																																																																																																																																																																																																											
Unperforated	0.10(L)	200	NC	0.40	0.20	0.10	0.10	0.10	0.15	0.15																																																																																																																																																																																																										
Rg 0701 + VLSRX	0.65(LM)	200	C	0.50	0.85	0.90	0.65	0.60	0.50	0.75																																																																																																																																																																																																										
Rg 0704 + VLSRX	0.80(L)	200	B	0.45	0.85	0.95	0.75	0.75	0.70	0.85																																																																																																																																																																																																										
Rd 1522 + VLSRX	0.60	200	C	0.25	0.60	0.75	0.50	0.60	0.60	0.60																																																																																																																																																																																																										
Rg 2516 + VLSRX	0.70	200	C	0.30	0.70	0.85	0.60	0.70	0.70	0.70																																																																																																																																																																																																										
	<b>Values for single suspended canopies: METAL Sonic Element</b>																																																																																																																																																																																																																			
	<table border="1"> <thead> <tr> <th rowspan="3"></th> <th colspan="3">Canopy dimensions</th> <th colspan="8">EN ISO 354</th> </tr> <tr> <th rowspan="2">Length (A) [mm]</th> <th rowspan="2">Width (B) [mm]</th> <th rowspan="2">Height (H) [mm]</th> <th rowspan="2">Sabines</th> <th rowspan="2">Cavity (C) [mm]</th> <th colspan="6">Frequency (Hz) α<sub>p</sub></th> </tr> <tr> <th>125</th> <th>250</th> <th>500</th> <th>1000</th> <th>2000</th> <th>4000</th> </tr> </thead> <tbody> <tr> <td rowspan="3">Rg 0701 + VLSRX</td> <td>1200</td> <td>1200</td> <td>40</td> <td>0.98</td> <td>150</td> <td>0.25</td> <td>0.75</td> <td>1.00</td> <td>1.00</td> <td>0.95</td> <td>0.70</td> </tr> <tr> <td>1800</td> <td>1200</td> <td>40</td> <td>1.43</td> <td>150</td> <td>0.40</td> <td>1.00</td> <td>1.00</td> <td>1.00</td> <td>1.00</td> <td>1.00</td> </tr> <tr> <td>1200</td> <td>1200</td> <td>40</td> <td>1.06</td> <td>300</td> <td>0.40</td> <td>0.95</td> <td>1.00</td> <td>1.00</td> <td>1.00</td> <td>0.80</td> </tr> <tr> <td rowspan="3">Rg 0704 + VLSRX</td> <td>1800</td> <td>1200</td> <td>40</td> <td>1.49</td> <td>300</td> <td>0.60</td> <td>1.00</td> <td>1.00</td> <td>1.00</td> <td>1.00</td> <td>1.00</td> </tr> <tr> <td>1200</td> <td>1200</td> <td>40</td> <td>1.18</td> <td>150</td> <td>0.30</td> <td>0.85</td> <td>1.00</td> <td>1.00</td> <td>1.00</td> <td>1.00</td> </tr> <tr> <td>1800</td> <td>1200</td> <td>40</td> <td>1.65</td> <td>150</td> <td>0.50</td> <td>1.00</td> <td>1.00</td> <td>1.00</td> <td>1.00</td> <td>1.00</td> </tr> <tr> <td rowspan="3">Rd 1522 + VLSRX</td> <td>1200</td> <td>1200</td> <td>40</td> <td>1.23</td> <td>300</td> <td>0.50</td> <td>1.00</td> <td>1.00</td> <td>1.00</td> <td>1.00</td> <td>1.00</td> </tr> <tr> <td>1800</td> <td>1200</td> <td>40</td> <td>1.79</td> <td>300</td> <td>0.80</td> <td>1.00</td> <td>1.00</td> <td>1.00</td> <td>1.00</td> <td>1.00</td> </tr> <tr> <td>1200</td> <td>1200</td> <td>40</td> <td>0.93</td> <td>150</td> <td>0.20</td> <td>0.45</td> <td>1.00</td> <td>1.00</td> <td>1.00</td> <td>0.95</td> </tr> <tr> <td rowspan="3">Rg 2516 + VLSRX</td> <td>1800</td> <td>1200</td> <td>40</td> <td>1.34</td> <td>150</td> <td>0.20</td> <td>0.70</td> <td>1.00</td> <td>1.00</td> <td>1.00</td> <td>1.00</td> </tr> <tr> <td>1200</td> <td>1200</td> <td>40</td> <td>0.96</td> <td>300</td> <td>0.35</td> <td>0.85</td> <td>0.90</td> <td>0.90</td> <td>1.00</td> <td>0.95</td> </tr> <tr> <td>1800</td> <td>1200</td> <td>40</td> <td>1.42</td> <td>300</td> <td>0.50</td> <td>1.00</td> <td>1.00</td> <td>1.00</td> <td>1.00</td> <td>1.00</td> </tr> <tr> <td rowspan="3"></td> <td>1200</td> <td>1200</td> <td>40</td> <td>1.10</td> <td>150</td> <td>0.20</td> <td>0.60</td> <td>1.00</td> <td>1.00</td> <td>1.00</td> <td>1.00</td> </tr> <tr> <td>1800</td> <td>1200</td> <td>40</td> <td>1.59</td> <td>150</td> <td>0.30</td> <td>0.85</td> <td>1.00</td> <td>1.00</td> <td>1.00</td> <td>1.00</td> </tr> <tr> <td>1200</td> <td>1200</td> <td>40</td> <td>1.17</td> <td>300</td> <td>0.40</td> <td>1.00</td> <td>1.00</td> <td>1.00</td> <td>1.00</td> <td>1.00</td> </tr> <tr> <td>1800</td> <td>1200</td> <td>40</td> <td>1.70</td> <td>300</td> <td>0.65</td> <td>1.00</td> <td>1.00</td> <td>1.00</td> <td>1.00</td> <td>1.00</td> </tr> </tbody> </table>			Canopy dimensions			EN ISO 354								Length (A) [mm]	Width (B) [mm]	Height (H) [mm]	Sabines	Cavity (C) [mm]	Frequency (Hz) α <sub>p</sub>						125	250	500	1000	2000	4000	Rg 0701 + VLSRX	1200	1200	40	0.98	150	0.25	0.75	1.00	1.00	0.95	0.70	1800	1200	40	1.43	150	0.40	1.00	1.00	1.00	1.00	1.00	1200	1200	40	1.06	300	0.40	0.95	1.00	1.00	1.00	0.80	Rg 0704 + VLSRX	1800	1200	40	1.49	300	0.60	1.00	1.00	1.00	1.00	1.00	1200	1200	40	1.18	150	0.30	0.85	1.00	1.00	1.00	1.00	1800	1200	40	1.65	150	0.50	1.00	1.00	1.00	1.00	1.00	Rd 1522 + VLSRX	1200	1200	40	1.23	300	0.50	1.00	1.00	1.00	1.00	1.00	1800	1200	40	1.79	300	0.80	1.00	1.00	1.00	1.00	1.00	1200	1200	40	0.93	150	0.20	0.45	1.00	1.00	1.00	0.95	Rg 2516 + VLSRX	1800	1200	40	1.34	150	0.20	0.70	1.00	1.00	1.00	1.00	1200	1200	40	0.96	300	0.35	0.85	0.90	0.90	1.00	0.95	1800	1200	40	1.42	300	0.50	1.00	1.00	1.00	1.00	1.00		1200	1200	40	1.10	150	0.20	0.60	1.00	1.00	1.00	1.00	1800	1200	40	1.59	150	0.30	0.85	1.00	1.00	1.00	1.00	1200	1200	40	1.17	300	0.40	1.00	1.00	1.00	1.00	1.00	1800	1200	40	1.70	300	0.65	1.00	1.00	1.00	1.00	1.00
	Canopy dimensions			EN ISO 354																																																																																																																																																																																																																
	Length (A) [mm]	Width (B) [mm]		Height (H) [mm]	Sabines	Cavity (C) [mm]	Frequency (Hz) α <sub>p</sub>																																																																																																																																																																																																													
			125				250	500	1000	2000	4000																																																																																																																																																																																																									
Rg 0701 + VLSRX	1200	1200	40	0.98	150	0.25	0.75	1.00	1.00	0.95	0.70																																																																																																																																																																																																									
	1800	1200	40	1.43	150	0.40	1.00	1.00	1.00	1.00	1.00																																																																																																																																																																																																									
	1200	1200	40	1.06	300	0.40	0.95	1.00	1.00	1.00	0.80																																																																																																																																																																																																									
Rg 0704 + VLSRX	1800	1200	40	1.49	300	0.60	1.00	1.00	1.00	1.00	1.00																																																																																																																																																																																																									
	1200	1200	40	1.18	150	0.30	0.85	1.00	1.00	1.00	1.00																																																																																																																																																																																																									
	1800	1200	40	1.65	150	0.50	1.00	1.00	1.00	1.00	1.00																																																																																																																																																																																																									
Rd 1522 + VLSRX	1200	1200	40	1.23	300	0.50	1.00	1.00	1.00	1.00	1.00																																																																																																																																																																																																									
	1800	1200	40	1.79	300	0.80	1.00	1.00	1.00	1.00	1.00																																																																																																																																																																																																									
	1200	1200	40	0.93	150	0.20	0.45	1.00	1.00	1.00	0.95																																																																																																																																																																																																									
Rg 2516 + VLSRX	1800	1200	40	1.34	150	0.20	0.70	1.00	1.00	1.00	1.00																																																																																																																																																																																																									
	1200	1200	40	0.96	300	0.35	0.85	0.90	0.90	1.00	0.95																																																																																																																																																																																																									
	1800	1200	40	1.42	300	0.50	1.00	1.00	1.00	1.00	1.00																																																																																																																																																																																																									
	1200	1200	40	1.10	150	0.20	0.60	1.00	1.00	1.00	1.00																																																																																																																																																																																																									
	1800	1200	40	1.59	150	0.30	0.85	1.00	1.00	1.00	1.00																																																																																																																																																																																																									
	1200	1200	40	1.17	300	0.40	1.00	1.00	1.00	1.00	1.00																																																																																																																																																																																																									
1800	1200	40	1.70	300	0.65	1.00	1.00	1.00	1.00	1.00																																																																																																																																																																																																										
Fire reaction	Unperforated: <b>Euroclass A1</b> ; Rg 0701 / Rg 0704 with acoustic fleece VLSRX: <b>Euroclass A2-s1, d0</b> ; Rd 1522 / Rg 2516 with acoustic fleece VLSRX: <b>Euroclass A2-s2, d0</b> ; as per EN 13501-1																																																																																																																																																																																																																			
Light reflectance	RAL 9010 unperforated: <b>85%</b> ; RAL 9010 Rd 1522: <b>66%</b> ; RAL 9010 Rg 0701: <b>83%</b> ; RAL 9010 Rg 2516: <b>73%</b> ; RAL 9010 Rg 0704: <b>82%</b>																																																																																																																																																																																																																			
Humidity resistance	<b>90% RH</b>																																																																																																																																																																																																																			
Indoor air quality	A+                      E1                      IAC Gold																																																																																																																																																																																																																			
Sustainability/Cleanability	17.3% (2023)                      ISO 9001                      EN 15804                      cradle to cradle SILVER																																																																																																																																																																																																																			

# KNAUF

## METAL Baffle Element

Linear & Baffle Solutions



© Szymon Polanski

- Fully configurable solution with variable baffles spacing.
- Different baffle height and width combinations and radial installations possible.
- Grouped or single suspended option for a modern linear appearance.
- Perforated acoustic baffles help reduce noise levels and reverberation times, increasing speech intelligibility.
- Additional design options available as part of our Vario Design range.
- Baffles are typically used in acoustically-challenged spaces, in airports, rail terminals, semi-exposed soffit buildings, offices, retail, leisure centres, etc.

**Build on us.**

# METAL Baffle Element

METAL Baffle Element - single suspended

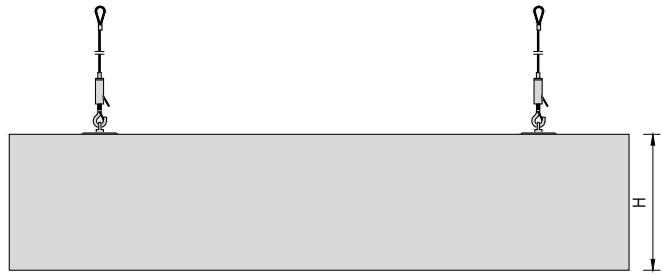
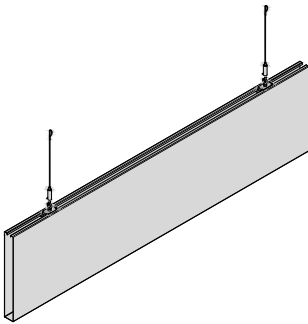

**Baffles**  
 Material post-coated galvanised steel 0.6 mm  
 Edge detail square edged  
 Dimensions length (L) 1800 mm / width (W) 30 mm / height (H) 300 mm

**Suspension system**  
 Standard hanging wire (4000 mm length), 2 pcs/baffle needed  
 Features splice connector  
 end caps

METAL Baffle Element - grouped

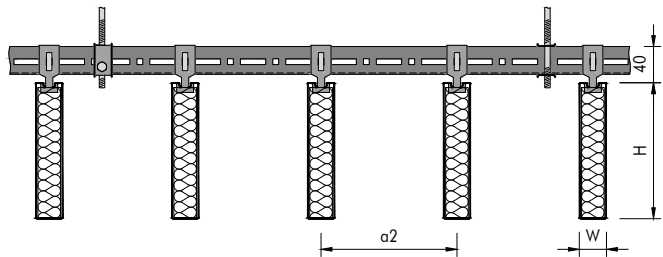
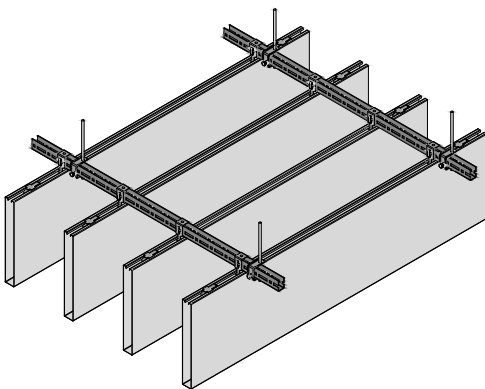

**Baffles**  
 Material post-coated galvanised steel 0.6 mm  
 Edge detail square edged hook-on  
 Dimensions length (L) max. 3000 mm  
 width (W) 20, 30, 40, 50 60 mm  
 height (H) 100, 150, 200, 250, 300 mm  
 variable spacing (a2) between the baffles

**Suspension system**  
 Standard U-Profile + hanger for baffle  
 Features splice connector  
 end caps  
 radial layout  
 for corridors  
 METAL Baffle Sky Element with crossing baffle layout

# METAL Baffle Element

METAL Baffle Element - single suspended

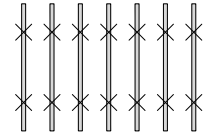

METAL Baffle Element - grouped

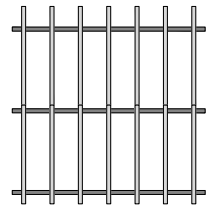
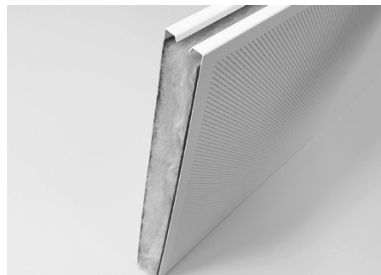
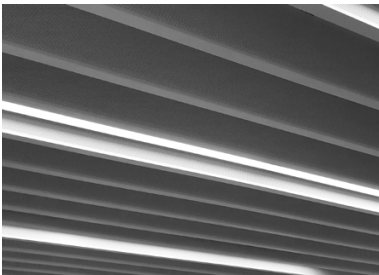

METAL Baffle Element end cap option



If the baffles do not run wall to wall, end caps can be used to cover the open end of the baffles.

METAL Baffle Sky Element option



A design alternative is with baffles, which are arranged crossing. Further details on request.

	VarioDesign options on request										Features & performances						
	Dimensions	Shapes	Post-coated aluminium	Perforations	RAL & NCS colours	BioGuard finish	Wood effect finish	Acoustic infills	Cut-outs	Grid alternatives	Secure function	Swing-down function	Clean room*	Seismic*	Impact resistance*	Suitable for chilled ceilings	Exterior*
<b>METAL Baffle Element</b>	■		■	■	■		■		■	■	■						

\* see separate datasheet

Characteristic		Detailed information													
Colour / Perforations												RAL 9016 RAL 9010 RAL 9006 RAL 9007 RAL 9005 further RAL & NCS colours on request		Unperforated Rg 0701 Rg 0704 Rg 1511 Rd 1522 further options see acoustic datasheet	
Acoustic infills		Acoustic pad AMV 25 kg/m <sup>3</sup>													
Weight		<b>1.1 - 4.1 kg/m</b>													
Acoustics		Weight varies depending on the perforation and acoustic infill.													
Values for grouped option	Baffle dimensions	EN ISO 354											NRC		
		Distance (a2) [mm]	Width (W) [mm]	Height (H) [mm]	α <sub>w</sub>	Cavity [mm]	Class	Frequency (Hz) α <sub>w</sub>							
Rg 0701 + AMV	300	30	300	0.50	50	D	0.20	0.40	0.45	0.70	0.65	0.40	0.55		
	450	30	300	0.35	50	D	0.15	0.30	0.30	0.50	0.45	0.25	0.40		
	300	30	300	0.55	300	D	0.15	0.30	0.50	0.70	0.65	0.45	0.55		
	450	30	300	0.40	300	D	0.10	0.20	0.35	0.50	0.45	0.25	0.40		
	300	30	300	0.55	600	D	0.15	0.35	0.50	0.70	0.65	0.55	0.55		
Rg 0704 + AMV	100	30	100	0.50(H)	50	D	0.05	0.30	0.45	0.50	0.75	0.75	0.50		
	150	60	100	0.65	50	C	0.15	0.45	0.60	0.65	0.80	0.70	0.60		
	200	30	200	0.50(H)	50	D	0.15	0.30	0.40	0.65	0.80	0.70	0.55		
	200	60	200	0.65	50	C	0.30	0.45	0.60	0.85	0.80	0.75	0.70		
	300	30	300	0.50(H)	50	D	0.20	0.30	0.40	0.70	0.75	0.65	0.55		
Rg 1511 + AMV	300	60	300	0.65(M)	50	C	0.30	0.45	0.60	0.90	0.80	0.70	0.65		
	300	30	300	0.60	50	C	0.20	0.40	0.50	0.70	0.75	0.65	0.55		
	450	30	300	0.45	50	D	0.15	0.35	0.35	0.45	0.55	0.50	0.45		
	300	30	300	0.60	300	C	0.15	0.35	0.55	0.75	0.75	0.70	0.60		
	450	30	300	0.40	300	D	0.10	0.20	0.35	0.50	0.50	0.50	0.40		
Rd 1522 + AMV	300	30	300	0.60(H)	600	C	0.20	0.35	0.55	0.70	0.75	0.75	0.55		
	450	30	300	0.45(H)	600	D	0.15	0.25	0.35	0.50	0.55	0.60	0.40		
	100	30	100	0.50(H)	50	D	0.10	0.30	0.45	0.50	0.70	0.65	0.45		
	150	60	100	0.60	50	C	0.15	0.45	0.55	0.55	0.60	0.55	0.55		
	150	30	150	0.60	50	C	0.25	0.50	0.50	0.60	0.75	0.65	0.60		
	150	50	150	0.55	50	D	0.20	0.40	0.45	0.70	0.70	0.60	0.60		
	300	30	150	0.45	50	D	0.15	0.30	0.35	0.45	0.55	0.50	0.40		
	150	30	150	0.55	200	D	0.15	0.40	0.45	0.60	0.75	0.65	0.55		
	300	30	150	0.40	200	D	0.10	0.25	0.30	0.45	0.55	0.50	0.40		
	150	30	150	0.55	600	D	0.20	0.30	0.50	0.65	0.70	0.65	0.55		
	300	30	150	0.35	600	D	0.10	0.15	0.30	0.40	0.45	0.45	0.35		
	200	30	200	0.50(H)	50	D	0.15	0.30	0.40	0.60	0.75	0.70	0.55		
	200	60	200	0.60	50	C	0.25	0.40	0.55	0.80	0.70	0.65	0.65		
	300	30	300	0.50(MH)	50	D	0.20	0.30	0.40	0.75	0.75	0.70	0.55		
	300	60	300	0.65	50	C	0.30	0.40	0.60	0.85	0.70	0.70	0.65		
450	30	300	0.45	50	D	0.15	0.30	0.35	0.45	0.55	0.50	0.40			
300	30	300	0.55(H)	300	D	0.15	0.30	0.50	0.70	0.75	0.70	0.60			
450	30	300	0.45	300	D	0.10	0.25	0.35	0.50	0.50	0.50	0.40			
300	30	300	0.55(H)	600	D	0.20	0.35	0.50	0.70	0.75	0.80	0.55			
450	30	300	0.40(H)	600	D	0.15	0.20	0.35	0.50	0.55	0.65	0.40			
α <sub>w</sub> : as per EN ISO 11654 / NRC: as per ASTM C 423-01															
Values for single suspended option	Baffle dimensions	EN ISO 354													
		Length (L) [mm]	Width (W) [mm]	Height (H) [mm]	Sabines	Cavity (C) [mm]	125	250	500	1000	2000	4000			
Rg 0701 + AMV	1800	30	300	0,64	1000	0,00	0,30	0,60	0,90	0,70	0,40				
Rg 1511 + AMV	1800	30	300	0,72	1000	0,10	0,30	0,60	0,80	0,90	0,90				
Rd 1522 + AMV	1800	30	150	0,35	1000	-0,10	0,10	0,20	0,40	0,50	0,50				
	1800	30	300	0,67	1000	0,10	0,30	0,50	0,70	0,90	0,80				
Fire reaction		<b>Euroclass A2-s2, d0;</b> as per EN 13501-1													
Light reflectance		RAL 9010 unperforated: <b>85%;</b> RAL 9010 Rg 1511: <b>76%;</b>			RAL 9010 Rg 0701: <b>83%;</b> RAL 9010 Rd 1522: <b>66%</b>				RAL 9010 Rg 0704: <b>82%;</b>						
Humidity resistance		<b>90% RH</b>													
Indoor air quality					A E1 IAC Gold										
Sustainability/ Cleanability									17.3% (2023) Unperforated option only						

# KNAUF

## METAL Linear Lite

*Metal Linear Ceilings*



© Knauf Ceiling Solutions

**Build on us.**

METAL Linear Lite offers a clean and modern aesthetic

- Versatile and durable linear solutions that are easy to install and maintain
- Additional design options available as part of our Vario design range

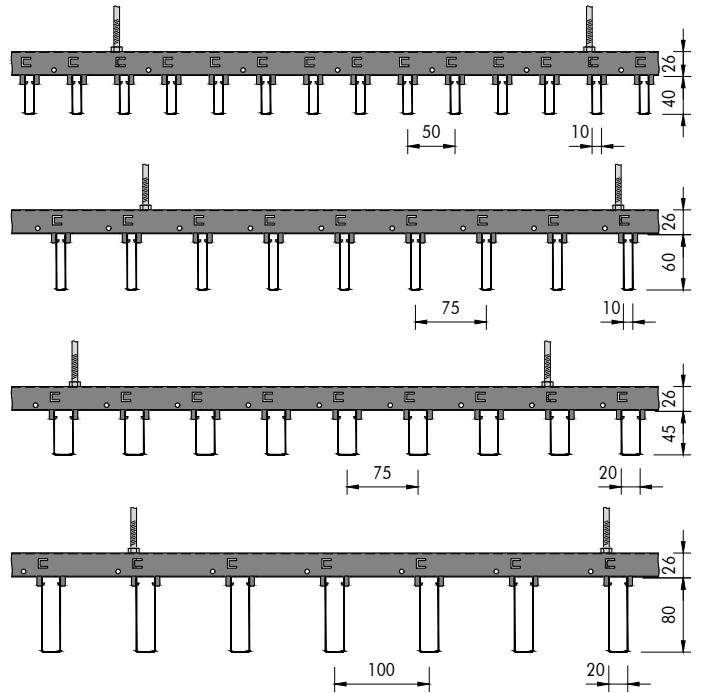
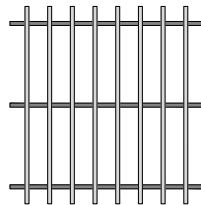
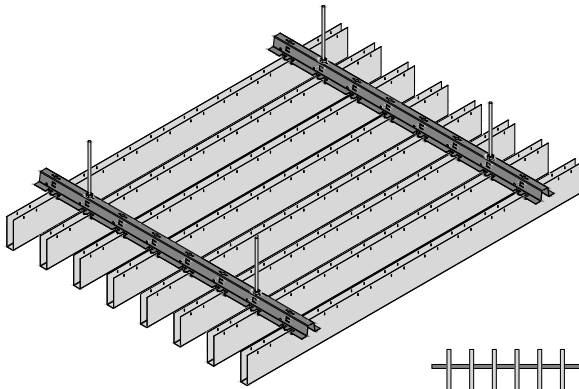













**Baffles**

- Material pre-coated aluminium 0.5 mm
- Edge detail square edged
- Dimensions length (L) 4000 mm  
 (Vario Design: min. 1000 / max. 4000 mm in steps of 100 mm)  
 width (W) x height (H) 10 x 40 / 10 x 60 / 20 x 45 / 20 x 80 mm

**Suspension system**

- Standard carrier profile
- Features end caps for 20 mm wide option

Characteristic	Detailed information	
Colour / Perforations		  RAL 9016 RAL 9005 further colours on request
Weight		<b>0.12–0.28 kg/m<sup>2</sup></b>
Fire reaction		<b>Euroclass A2-s1, d0;</b> as per EN 13501-1
Light reflectance		RAL 9016: <b>87%</b> , RAL 9005: <b>4%</b>
Humidity resistance		<b>90% RH</b>
Indoor air quality		 A (French VOC)
Cleanability	  	



# METAL Linear Blade

Metal Linear Ceilings



© Knauf Ceiling Solutions

METAL Linear Blade provide a sleek and modern look that can complement a variety of architectural styles

- The clean lines and simple design create a sense of order and sophistication in any space.
- Three different blade heights can be combined on the same hanger for a more 3 dimensional feel
- Additionally the distance between each blade can be configured to create more design effects

**Build on us.**

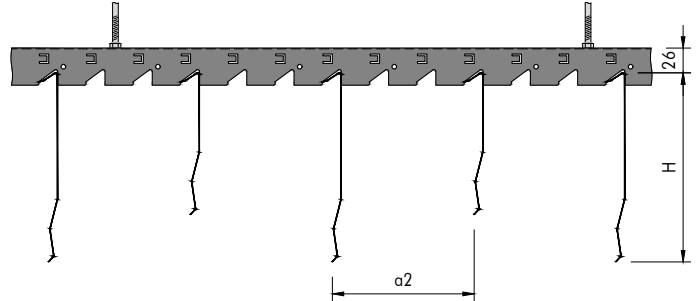
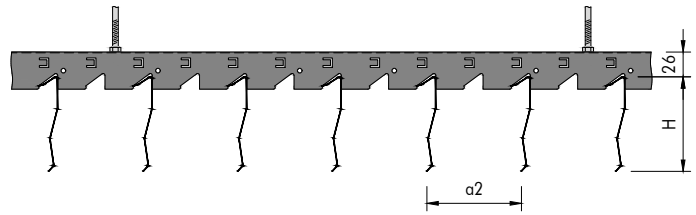
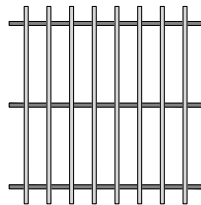
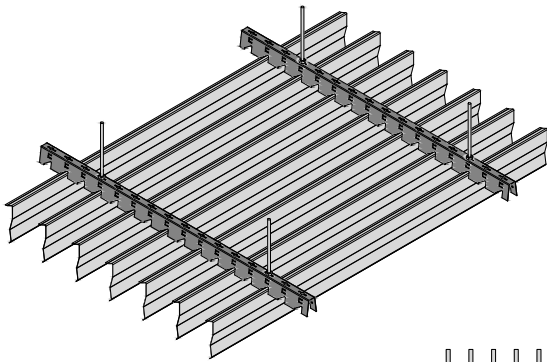













**Blades**

- Material pre-coated aluminium 0.6 mm
- Edge detail square edged
- Dimensions length (L) 4000 mm  
(Vario Design: min. 1000 / max. 4000 mm)  
height (H) 100 / 150 / 200 mm
- Spacing (a2) recommended spacing = height (H)

**Suspension system**

- Standard carrier profile

Characteristic	Detailed information	
Colour / Perforations		  RAL 9016 RAL 9005 further colours on request
Weight		<b>0.20–0.36 kg/m<sup>2</sup></b>
Fire reaction		<b>Euroclass A2-s1, d0;</b> as per EN 13501-1
Light reflectance		RAL 9016: <b>87%</b> , RAL 9005: <b>4%</b>
Humidity resistance		<b>90% RH</b>
Indoor air quality		 A (French VOC)
Cleanability	  	

## METAL Linear Stripe

Metal Linear Ceilings



© Knauf Ceiling Solutions

METAL Linear Stripe solutions offer endless possibility for combinations and creative design

- Linear Stripes are available in a variety of colours, widths, heights and lengths using the same hanging profile
- Combine horizontal and vertical modules in different dimensions and colours for ultimate design freedom
- In addition to standard colours, Linear Stripes are also available in WOOD Design effects
- Additional design options available as part of our Vario design range

**Build on us.**



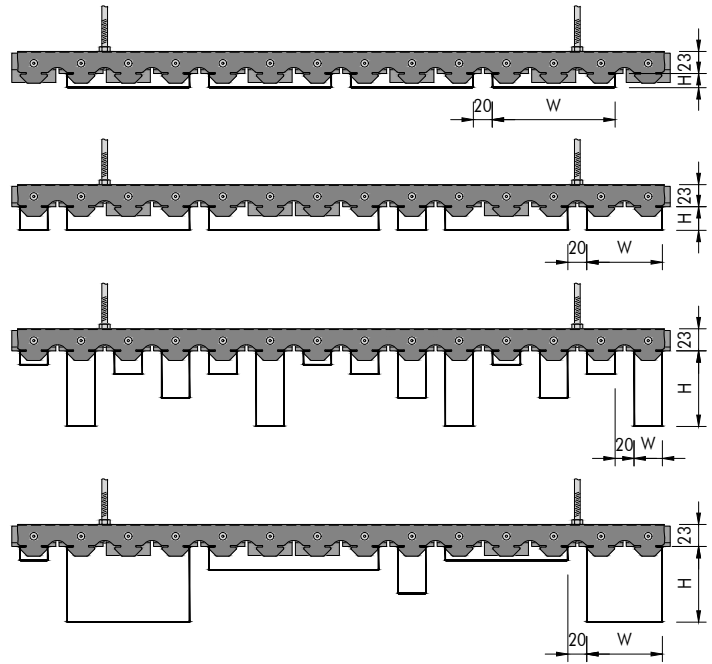
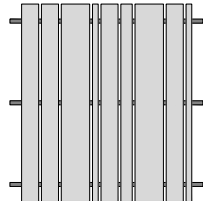
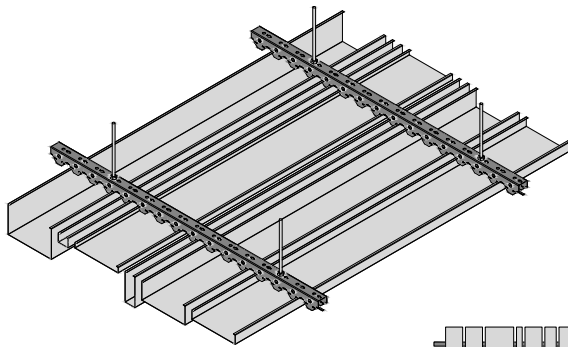

**Stripes**

- Material pre-coated aluminium 0.6 mm
- Edge detail square edged
- Dimensions length (L) 3000 mm  
 (Vario Design: min. 1000 / max. 4000 mm)  
 width (W) x height (H)  
 30 x 15 / 80 x 15 / 130 x 15 / 180 x 15 mm  
 30 x 25 / 80 x 25 / 130 x 25 / 180 x 25 mm  
 30 x 50 / 80 x 50 / 130 x 50 mm  
 30 x 80 / 80 x 80 / 130 x 80 mm

**Suspension system**

- Standard carrier profile

Characteristic	Detailed information	
Colour / Perforations		<p>RAL 9016 RAL 7016 RAL 9005 Oak Light Oak Dark</p> <p>further colours on request</p>
Weight		<b>0.11 – 0.48 kg/m<sup>2</sup></b>
Fire reaction		<b>Euroclass A1;</b> as per EN 13501-1
Light reflectance		RAL 9016: <b>87%</b> , RAL 7016: <b>8%</b> , RAL 9005: <b>4%</b>
Humidity resistance		<b>90% RH</b>
Indoor air quality		<p>A+ (French VOC)</p>
Cleanability		

# KNAUF

## **METAL** **F-L 601, F-Clip,** **F-H 600,** **F-H 600 Swing** *Free Span Corridor Solutions*

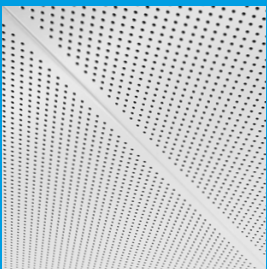

© Foto Lautenschlager

- These lay-in, clip-in or hook-on are rectangular panel free-span solutions that simply span between the walls, allowing for easy installation and access to services.
- Adjustable perimeter shadow gap detailing for METAL F-Clip, METAL F-H 600 and METAL F-H 600 Swing.
- Maintenance-friendly system with easy, quick access to ceiling void due to swing-down functions.
- Additional design options available as part of our Vario Design range.
- Used in corridors where the panels simply span between walls.

## **Build on us.**

**METAL F-L 601**

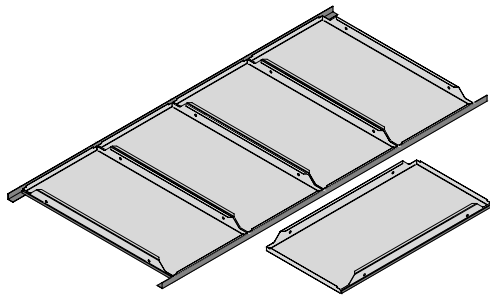

L-perimeter trim option

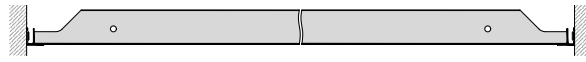

Shadowline perimeter trim option

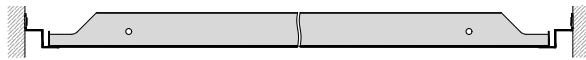

Panels  
 Material post-coated galvanised steel 0.6 / 0.7 mm  
 Edge detail square edged lay-in, with 3 mm gasket on long edge  
 Dimensions length (A) 600 - 3300 mm / width (B) 247 - 1350 mm  
 Panel size max. 2 m<sup>2</sup>

Suspension system  
 Standard L-perimeter trim range  
 Optional shadowline perimeter trim range for a minimal installation height

**METAL F-Clip**

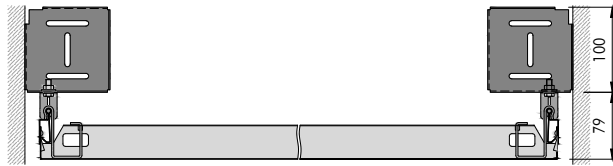
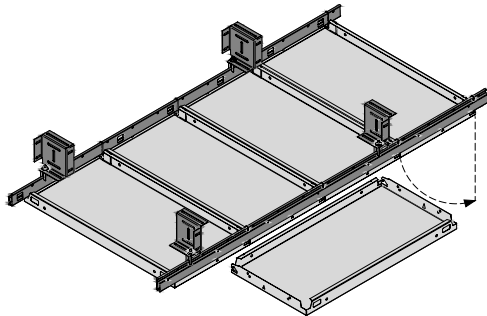

Panels  
 Material post-coated galvanised steel 0.6 / 0.7 mm  
 Edge detail square edged clip-in  
 Dimensions length (A) 600 - 2500 mm / width (B) 250 - 600 mm  
 Panel size max. 1.5 m<sup>2</sup>

Suspension system  
 Standard Wall bracket + half DP12 A-Bar (2 - 80 mm open shadow gap to wall)  
 Optional Wall bracket + DP12 A-Bar (10 - 89 mm open shadow gap to wall)  
 Features swing-down function ACCESS, security clip

**METAL F-H 600**

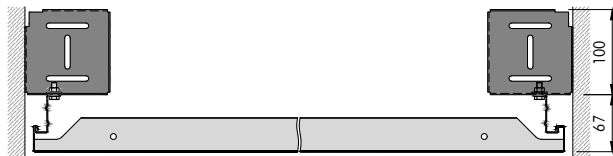
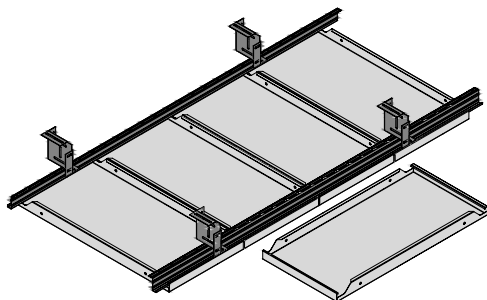

Panels  
 Material post-coated galvanised steel 0.6 / 0.7 mm  
 Edge detail square edged hook-on  
 Dimensions length (A) 600 - 3300 mm / width (B) 247 - 1350 mm  
 Panel size max. 2 m<sup>2</sup>

Suspension system  
 Standard Wall bracket + J-Bar (5 - 65 mm open shadow gap to wall)  
 Features security bracket

**METAL F-H 600 Swing**

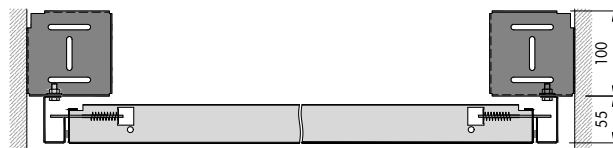
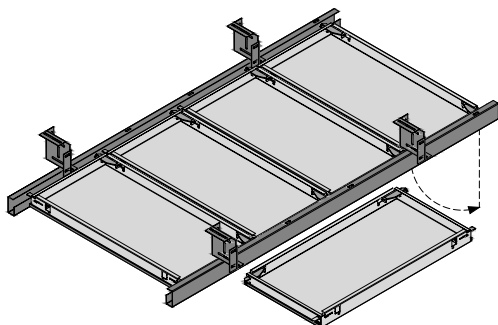

Panels  
 Material post-coated galvanised steel 0.6 / 0.7 mm  
 Edge detail square edged hook-on, with 3 mm gasket on long and both short sides  
 Dimensions length (A) 600 - 3300 mm / width (B) 247 - 1350 mm  
 Panel size max. 2 m<sup>2</sup>

Suspension system  
 Standard Wall bracket + G-Profile 25 mm (5 - 65 mm open shadow gap to wall)  
 Features swing-down function SWING

METAL F-L 601

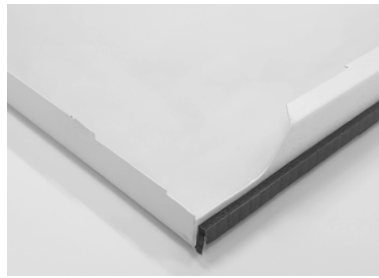
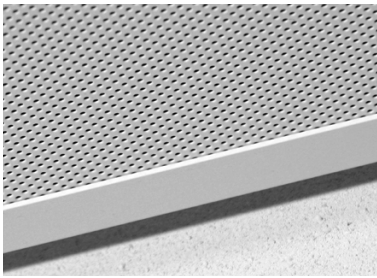

METAL F-Clip

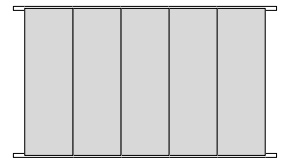
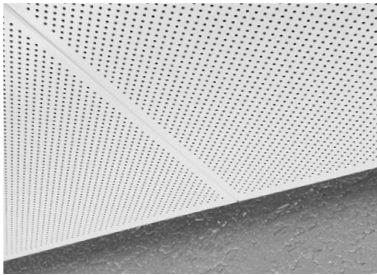

METAL F-H 600

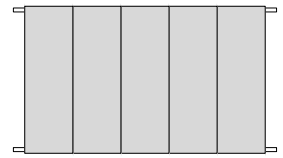
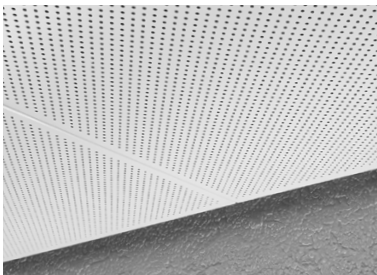

METAL F-H 600 Swing

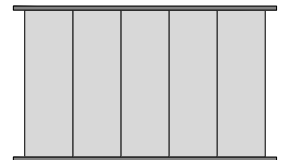

**Security clip / bracket options**

For METAL F-Clip

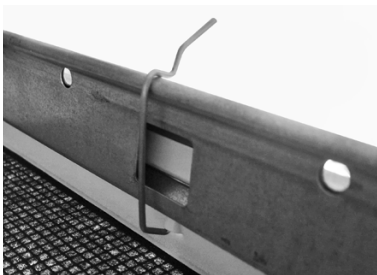

For METAL F-H 600



**Swing-down function Access**

For METAL F-Clip

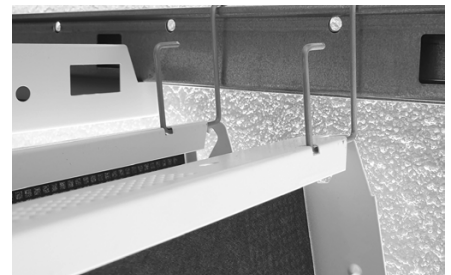

	VarioDesign options on request										Features & performances						
	Dimensions	Shapes	Post-coated aluminium	Perforations	RAL & NCS colours	BioGuard finish	Wood effect finish	Acoustic infills	Cut-outs	Grid alternatives	Secure function	Swing-down function	Clean room*	Seismic*	Impact resistance*	Suitable for chilled ceilings	Exterior*
<b>METAL F-L 601</b>	■	■	■	■	■	■	■	■	■								
<b>METAL F-Clip</b>	■		■	■	■	■	■	■	■	■	■						
<b>METAL F-H 600</b>	■	■	■	■	■	■	■	■	■		■					■	
<b>METAL F-H 600 Swing</b>	■		■	■	■	■	■	■	■			■				■	

\* see separate datasheet

Characteristic	Detailed information																																																																																																																							
Colour / Perforations	RAL 9016                      RAL 9010                      RAL 9006                      RAL 9007                      RAL 9005 further RAL & NCS colours on request	Unperforated                      Rg 0701                      Rg 0704                      Rd 1522                      Rg 2516 further options see acoustic datasheet																																																																																																																						
Acoustic infills	Black acoustic fleece VLSRX further options see acoustic datasheet																																																																																																																							
Weight	<b>5.0 - 6.9 kg/m</b> Weight varies depending on the perforation and acoustic infill.																																																																																																																							
Acoustics	<table border="1"> <thead> <tr> <th rowspan="3"></th> <th colspan="10">EN ISO 354</th> <th>EN ISO 10848-2</th> <th>EN ISO 10140-2</th> </tr> <tr> <th rowspan="2"><math>\alpha_w</math></th> <th rowspan="2">Cavity [mm]</th> <th rowspan="2">Class</th> <th colspan="6">Frequency (Hz) <math>\alpha_w</math></th> <th rowspan="2">NRC</th> <th rowspan="2"><math>D_{n,w}</math> [dB]</th> <th rowspan="2"><math>R_w</math> [dB]</th> <th rowspan="2">CAC [dB]</th> </tr> <tr> <th>125</th> <th>250</th> <th>500</th> <th>1000</th> <th>2000</th> <th>4000</th> </tr> </thead> <tbody> <tr> <td>Unperforated</td> <td>0.10(L)</td> <td>200</td> <td>NC</td> <td>0.40</td> <td>0.20</td> <td>0.10</td> <td>0.10</td> <td>0.10</td> <td>0.10</td> <td>0.15</td> <td>0.15</td> <td>34</td> <td>19</td> <td>35</td> </tr> <tr> <td>Rg 0701 + VLSRX</td> <td>0.65(LM)</td> <td>200</td> <td>C</td> <td>0.50</td> <td>0.85</td> <td>0.90</td> <td>0.65</td> <td>0.60</td> <td>0.50</td> <td>0.75</td> <td>0.75</td> <td>19</td> <td>10</td> <td>20</td> </tr> <tr> <td>Rg 0704 + VLSRX</td> <td>0.80(L)</td> <td>200</td> <td>B</td> <td>0.45</td> <td>0.85</td> <td>0.95</td> <td>0.75</td> <td>0.75</td> <td>0.70</td> <td>0.85</td> <td>0.85</td> <td>19</td> <td>10</td> <td>19</td> </tr> <tr> <td>Rd 1522 + VLSRX</td> <td>0.60</td> <td>200</td> <td>C</td> <td>0.25</td> <td>0.60</td> <td>0.75</td> <td>0.50</td> <td>0.60</td> <td>0.60</td> <td>0.60</td> <td>0.60</td> <td>14</td> <td>6</td> <td>15</td> </tr> <tr> <td>Rg 2516 + VLSRX</td> <td>0.70</td> <td>200</td> <td>C</td> <td>0.30</td> <td>0.70</td> <td>0.85</td> <td>0.60</td> <td>0.70</td> <td>0.70</td> <td>0.70</td> <td>0.70</td> <td>16</td> <td>6</td> <td>16</td> </tr> </tbody> </table>													EN ISO 354										EN ISO 10848-2	EN ISO 10140-2	$\alpha_w$	Cavity [mm]	Class	Frequency (Hz) $\alpha_w$						NRC	$D_{n,w}$ [dB]	$R_w$ [dB]	CAC [dB]	125	250	500	1000	2000	4000	Unperforated	0.10(L)	200	NC	0.40	0.20	0.10	0.10	0.10	0.10	0.15	0.15	34	19	35	Rg 0701 + VLSRX	0.65(LM)	200	C	0.50	0.85	0.90	0.65	0.60	0.50	0.75	0.75	19	10	20	Rg 0704 + VLSRX	0.80(L)	200	B	0.45	0.85	0.95	0.75	0.75	0.70	0.85	0.85	19	10	19	Rd 1522 + VLSRX	0.60	200	C	0.25	0.60	0.75	0.50	0.60	0.60	0.60	0.60	14	6	15	Rg 2516 + VLSRX	0.70	200	C	0.30	0.70	0.85	0.60	0.70	0.70	0.70	0.70	16	6	16	
	EN ISO 354										EN ISO 10848-2	EN ISO 10140-2																																																																																																												
	$\alpha_w$	Cavity [mm]	Class	Frequency (Hz) $\alpha_w$						NRC	$D_{n,w}$ [dB]	$R_w$ [dB]		CAC [dB]																																																																																																										
				125	250	500	1000	2000	4000																																																																																																															
Unperforated	0.10(L)	200	NC	0.40	0.20	0.10	0.10	0.10	0.10	0.15	0.15	34	19	35																																																																																																										
Rg 0701 + VLSRX	0.65(LM)	200	C	0.50	0.85	0.90	0.65	0.60	0.50	0.75	0.75	19	10	20																																																																																																										
Rg 0704 + VLSRX	0.80(L)	200	B	0.45	0.85	0.95	0.75	0.75	0.70	0.85	0.85	19	10	19																																																																																																										
Rd 1522 + VLSRX	0.60	200	C	0.25	0.60	0.75	0.50	0.60	0.60	0.60	0.60	14	6	15																																																																																																										
Rg 2516 + VLSRX	0.70	200	C	0.30	0.70	0.85	0.60	0.70	0.70	0.70	0.70	16	6	16																																																																																																										
	$\alpha_w$ : as per EN ISO 11654 / NRC: as per ASTM C 423-01 / $D_{n,w}$ : as per EN ISO 717-1 / CAC: as per ASTM E 413-10																																																																																																																							
Fire reaction	Unperforated: <b>Euroclass A1</b> ; Rg 0701 / Rg 0704 with acoustic fleece VLSRX: <b>Euroclass A2-s1, d0</b> ; Rd1522 / Rg 2516 with acoustic fleece VLSRX: <b>Euroclass A2-s2, d0</b> ; as per EN 13501-1																																																																																																																							
Light reflectance	RAL 9010 unperforated: <b>85%</b> ; RAL 9010 Rd 1522: <b>66%</b> ; RAL 9010 Rg 0701: <b>83%</b> ; RAL 9010 Rg 2516: <b>73%</b> ; RAL 9010 Rg 0704: <b>82%</b>																																																																																																																							
Humidity resistance	<b>90% RH</b>																																																																																																																							
Indoor air quality	A+                      E1                      IAC Gold																																																																																																																							
Sustainability	EN ISO 14021                      ISO 9001                      EN 15804                      cradle to cradle SILVER 17.3% (2023)																																																																																																																							
Cleanability																																																																																																																								

# KNAUF

## **METAL** *Wallcoustic Element, Wallcoustic Horizon 1000, Wallcoustic Horizon 1100* Wall Solutions

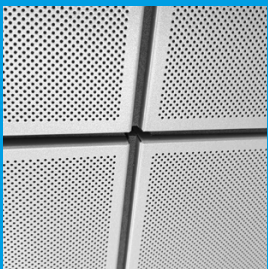

© EISMA

- METAL Wallcoustic Element is a range of wall solutions that help structure and define spaces and accentuate an area. They provide a focus or create wall sculptures that help control sound reverberation within a space.
- Fully configurable solution, available with different edge details, simple and fast installed by using a wall hanging kit.
- METAL Wallcoustic Horizon 1000 and METAL Wallcoustic Horizon 1100, are hook-on wall systems without visible fasteners which enable faster installation. Fully configurable large size panels, in either portrait or landscape orientation
- Additional design options available as part of our Vario Design range.
- Acoustic and architectural design elements for market segments such as office, education or transportation.

## **Build on us.**

# METAL Wallcoustic Element, Wallcoustic Horizon 1000, Wallcoustic Horizon 1100

## METAL Wallcoustic Element

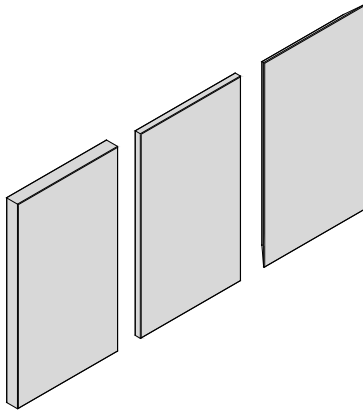

90° edge option

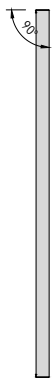

20 x 20 mm edge option

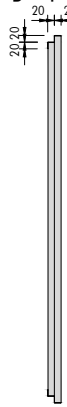

50° edge option

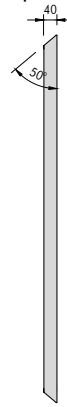

### Wall absorbers

Material	post-coated galvanised steel 0.7 mm
Edge detail	90°, 20 x 20 mm, 50° option delivered with two reinforcement profiles inside
Dimensions	length (A) 600 - 1800 mm / width (B) 600 - 1200 mm
Panel size	max. 2.16 m <sup>2</sup>
<b>Suspension system</b>	
Standard	wall hanging kit, 4 pcs/wall absorber needed
Features	Rg 2516 perforated rear cover

## METAL Wallcoustic Horizon 1000

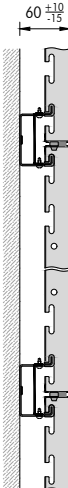
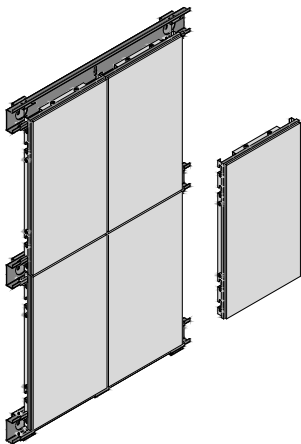

### Panels

Material	post-coated galvanised steel 1.0 mm
Edge detail	square edged hook-on with 5 mm gasket and spacers on long and short edge
Dimensions	panel type A upright: length (A) 600 - 1300 mm with 4 suspension points panel type B upright: length (A) 1301 - 2500 mm with 6 suspension points panel type C upright: length (A) 2501 - 3000 mm with 8 suspension points panel type D reclined: length (A) 600 - 2000 mm with 4 suspension points width (B) 250 - 1000 mm
Panel size	max. 3 m <sup>2</sup>
<b>Suspension system</b>	
Standard	C-Wall Profile
Features	perimeter, corner, connection details to doors and windows, etc. on request

## METAL Wallcoustic Horizon 1100

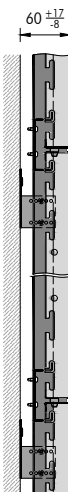
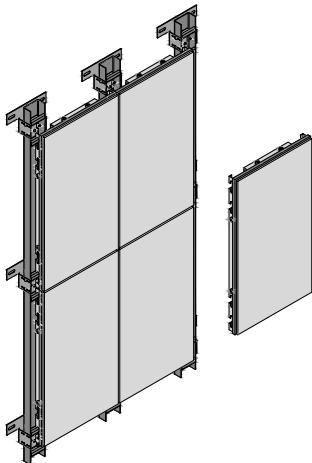

### Panels

Material	post-coated galvanised steel 1.0 mm
Edge detail	square edged hook-on with 5 mm gasket and spacers on long and short edge
Dimensions	panel type A upright: length (A) 600 - 1300 mm with 4 suspension points panel type B upright: length (A) 1301 - 2500 mm with 6 suspension points panel type C upright: length (A) 2501 - 3000 mm with 8 suspension points panel type D reclined: length (A) 600 - 2000 mm with 4 suspension points width (B) 250 - 1000 mm
Panel size	max. 3 m <sup>2</sup>
<b>Suspension system</b>	
Standard	U-Wall Profile
Features	perimeter, corner, connection details to doors and windows, etc. on request

**METAL Wallcoustic Element, Wallcoustic Horizon 1000, Wallcoustic Horizon 1100**

METAL Wallcoustic Element

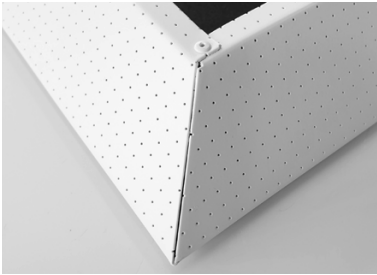
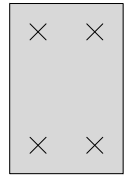
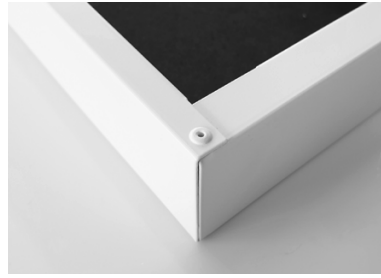

METAL Wallcoustic Horizon 1000

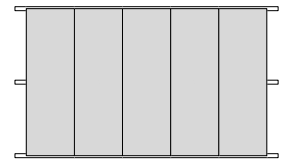
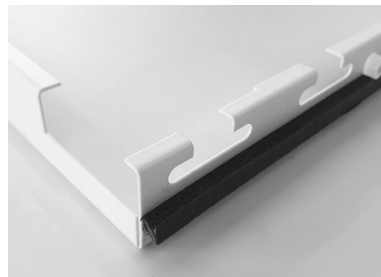
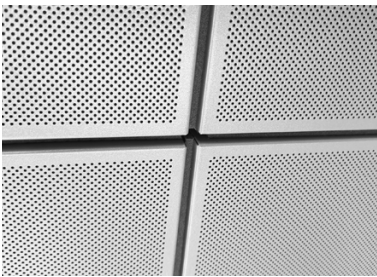

METAL Wallcoustic Horizon 1100

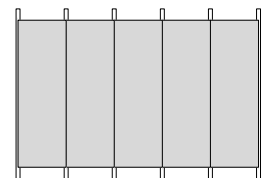
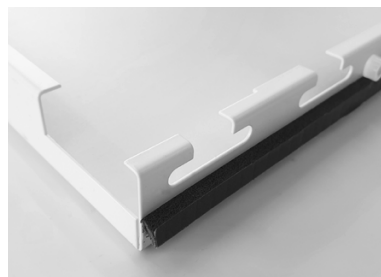
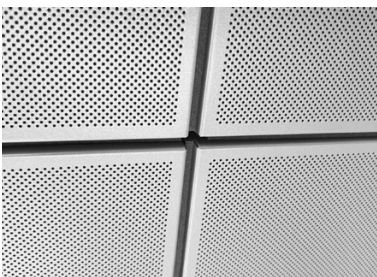

**Panel orientation for METAL Sonic Element**

Portrait orientation

Landscape orientation

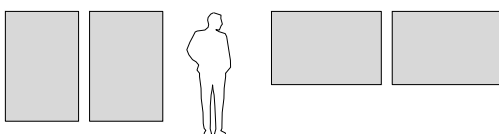

**Panel orientation for METAL Wallcoustic Horizon 1000 / METAL Wallcoustic Horizon 1100**

Portrait orientation

Landscape orientation

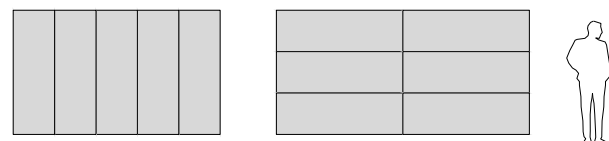

	VarioDesign options on request									Features & performances								
	Dimensions	Shapes	Post-coated aluminium	Perforations	RAL & NCS colours	BioGuard finish	Wood effect finish	Acoustic infills	Cut-outs	Grid alternatives	Secure function	Swing-down function	Clean room*	Seismic*	Impact resistance*	Fire resistance*	Suitable for chilled ceilings	Exterior*
<b>METAL Wallcoustic Element</b>	■	■	■	■	■	■	■	■	■									
<b>METAL Wallcoustic Horizon 1000</b>	■			■	■	■	■	■	■									
<b>METAL Wallcoustic Horizon 1100</b>	■			■	■	■	■	■	■									

\* see separate datasheet

Characteristic	Detailed information																																																																																																																																																																	
Colour / Perforations	RAL 9016                      RAL 9010                      RAL 9006                      RAL 9007                      RAL 9005 further RAL & NCS colours on request	Unperforated                      Rg 0701*                      Rg 0704*                      Rd 1522                      Rg 2516 further options see acoustic datasheet																																																																																																																																																																
Acoustic infills	Black acoustic fleece VLSRX further options see acoustic datasheet																																																																																																																																																																	
Weight	<b>3.9 - 26 kg/m<sup>2</sup></b> Weight varies depending on the perforation and acoustic infill.																																																																																																																																																																	
Acoustics	<b>Values for continuous solutions METAL Wallcoustic Horizon 1000, METAL Wallcoustic Horizon 1100</b>	<table border="1"> <thead> <tr> <th rowspan="2">α<sub>w</sub></th> <th rowspan="2">Cavity [mm]</th> <th rowspan="2">Class</th> <th colspan="6">EN ISO 354</th> <th rowspan="2">NRC</th> </tr> <tr> <th>125</th> <th>250</th> <th>500</th> <th>1000</th> <th>2000</th> <th>4000</th> </tr> </thead> <tbody> <tr> <td>Rd 1522 + VLSRX</td> <td>0.40(MH)</td> <td>60</td> <td>D</td> <td>0.05</td> <td>0.15</td> <td>0.35</td> <td>0.65</td> <td>0.75</td> <td>0.55</td> <td>0.45</td> </tr> <tr> <td>Rg 2516 + VLSRX</td> <td>0.45(MH)</td> <td>60</td> <td>D</td> <td>0.05</td> <td>0.15</td> <td>0.45</td> <td>0.85</td> <td>0.90</td> <td>0.65</td> <td>0.60</td> </tr> </tbody> </table> <p>α<sub>w</sub>: as per EN ISO 11654 / NRC: as per ASTM C 423-01</p> <table border="1"> <thead> <tr> <th rowspan="3">Values for single wall absorbers METAL Wallcoustic Element</th> <th colspan="3">Wall absorber dimensions</th> <th colspan="9">EN ISO 354</th> </tr> <tr> <th rowspan="2">Length (A) [mm]</th> <th rowspan="2">Width (B) [mm]</th> <th rowspan="2">Height (H) [mm]</th> <th rowspan="2">Sabines</th> <th rowspan="2">Cavity (C) [mm]</th> <th>125</th> <th>250</th> <th>500</th> <th>1000</th> <th>2000</th> <th>4000</th> </tr> <tr> <th>125</th> <th>250</th> <th>500</th> <th>1000</th> <th>2000</th> <th>4000</th> </tr> </thead> <tbody> <tr> <td rowspan="2">Rg 0701 + VLSRX</td> <td>1200</td> <td>1200</td> <td>40</td> <td>0.85</td> <td>50</td> <td>0.15</td> <td>0.40</td> <td>0.85</td> <td>1.00</td> <td>0.95</td> <td>0.60</td> </tr> <tr> <td>1800</td> <td>1200</td> <td>40</td> <td>1.17</td> <td>50</td> <td>0.25</td> <td>0.60</td> <td>1.00</td> <td>1.00</td> <td>1.00</td> <td>0.95</td> </tr> <tr> <td rowspan="2">Rg 0704 + VLSRX</td> <td>1200</td> <td>1200</td> <td>40</td> <td>0.97</td> <td>50</td> <td>0.10</td> <td>0.35</td> <td>0.75</td> <td>1.00</td> <td>1.00</td> <td>1.00</td> </tr> <tr> <td>1800</td> <td>1200</td> <td>40</td> <td>1.36</td> <td>50</td> <td>0.20</td> <td>0.45</td> <td>1.00</td> <td>1.00</td> <td>1.00</td> <td>1.00</td> </tr> <tr> <td rowspan="2">Rd 1522 + VLSRX</td> <td>1200</td> <td>1200</td> <td>40</td> <td>0.83</td> <td>50</td> <td>0.10</td> <td>0.15</td> <td>0.45</td> <td>1.00</td> <td>1.00</td> <td>0.95</td> </tr> <tr> <td>1800</td> <td>1200</td> <td>40</td> <td>1.15</td> <td>50</td> <td>0.10</td> <td>0.20</td> <td>0.55</td> <td>1.00</td> <td>1.00</td> <td>1.00</td> </tr> <tr> <td rowspan="2">Rg 2516 + VLSRX</td> <td>1200</td> <td>1200</td> <td>40</td> <td>0.98</td> <td>50</td> <td>0.10</td> <td>0.25</td> <td>0.60</td> <td>1.00</td> <td>1.00</td> <td>1.00</td> </tr> <tr> <td>1800</td> <td>1200</td> <td>40</td> <td>1.37</td> <td>50</td> <td>0.15</td> <td>0.35</td> <td>0.80</td> <td>1.00</td> <td>1.00</td> <td>1.00</td> </tr> </tbody> </table>	α <sub>w</sub>	Cavity [mm]	Class	EN ISO 354						NRC	125	250	500	1000	2000	4000	Rd 1522 + VLSRX	0.40(MH)	60	D	0.05	0.15	0.35	0.65	0.75	0.55	0.45	Rg 2516 + VLSRX	0.45(MH)	60	D	0.05	0.15	0.45	0.85	0.90	0.65	0.60	Values for single wall absorbers METAL Wallcoustic Element	Wall absorber dimensions			EN ISO 354									Length (A) [mm]	Width (B) [mm]	Height (H) [mm]	Sabines	Cavity (C) [mm]	125	250	500	1000	2000	4000	125	250	500	1000	2000	4000	Rg 0701 + VLSRX	1200	1200	40	0.85	50	0.15	0.40	0.85	1.00	0.95	0.60	1800	1200	40	1.17	50	0.25	0.60	1.00	1.00	1.00	0.95	Rg 0704 + VLSRX	1200	1200	40	0.97	50	0.10	0.35	0.75	1.00	1.00	1.00	1800	1200	40	1.36	50	0.20	0.45	1.00	1.00	1.00	1.00	Rd 1522 + VLSRX	1200	1200	40	0.83	50	0.10	0.15	0.45	1.00	1.00	0.95	1800	1200	40	1.15	50	0.10	0.20	0.55	1.00	1.00	1.00	Rg 2516 + VLSRX	1200	1200	40	0.98	50	0.10	0.25	0.60	1.00	1.00	1.00	1800	1200	40	1.37	50	0.15	0.35	0.80	1.00	1.00	1.00
α <sub>w</sub>	Cavity [mm]	Class				EN ISO 354							NRC																																																																																																																																																					
			125	250	500	1000	2000	4000																																																																																																																																																										
Rd 1522 + VLSRX	0.40(MH)	60	D	0.05	0.15	0.35	0.65	0.75	0.55	0.45																																																																																																																																																								
Rg 2516 + VLSRX	0.45(MH)	60	D	0.05	0.15	0.45	0.85	0.90	0.65	0.60																																																																																																																																																								
Values for single wall absorbers METAL Wallcoustic Element	Wall absorber dimensions			EN ISO 354																																																																																																																																																														
	Length (A) [mm]	Width (B) [mm]	Height (H) [mm]	Sabines	Cavity (C) [mm]	125	250	500	1000	2000	4000																																																																																																																																																							
						125	250	500	1000	2000	4000																																																																																																																																																							
Rg 0701 + VLSRX	1200	1200	40	0.85	50	0.15	0.40	0.85	1.00	0.95	0.60																																																																																																																																																							
	1800	1200	40	1.17	50	0.25	0.60	1.00	1.00	1.00	0.95																																																																																																																																																							
Rg 0704 + VLSRX	1200	1200	40	0.97	50	0.10	0.35	0.75	1.00	1.00	1.00																																																																																																																																																							
	1800	1200	40	1.36	50	0.20	0.45	1.00	1.00	1.00	1.00																																																																																																																																																							
Rd 1522 + VLSRX	1200	1200	40	0.83	50	0.10	0.15	0.45	1.00	1.00	0.95																																																																																																																																																							
	1800	1200	40	1.15	50	0.10	0.20	0.55	1.00	1.00	1.00																																																																																																																																																							
Rg 2516 + VLSRX	1200	1200	40	0.98	50	0.10	0.25	0.60	1.00	1.00	1.00																																																																																																																																																							
	1800	1200	40	1.37	50	0.15	0.35	0.80	1.00	1.00	1.00																																																																																																																																																							
Light reflectance	RAL 9010 unperforated: <b>85%</b> ; RAL 9010 Rd 1522: <b>66%</b> ; RAL 9010 Rg 0701: <b>83%</b> ; RAL 9010 Rg 2516: <b>73%</b> ; RAL 9010 Rg 0704: <b>82%</b> ;																																																																																																																																																																	
Humidity resistance	<b>90% RH</b>																																																																																																																																																																	
Indoor air quality	A+                      E1                      IAC Gold																																																																																																																																																																	
Sustainability/Cleanability	17.3% (2023)                      ISO 9001                      EN 15804                      cradle to cradle SILVER																																																																																																																																																																	

\* only for METAL Wallcoustic Element



# Parameters & Performances



## Colours & Finishes

Metal ceilings come in a wide array of colours and finishes. With so many colours and finishes to choose from, metal ceilings can be a great way to add visual interest and create the desired atmosphere within your project. Besides standard colours, we can offer a wide range of RAL & NCS colours as well as performance coatings or visual effects.



## Acoustics

We provide acoustic ceilings for every space, with ceilings that are as pleasing to the eye as they are to the ear. High sound absorption, high flanking transmission or a perfect balance of both; our high performing acoustical offer can help optimise comfort, intelligibility and privacy to focus the mind and promote effective collaboration.



## Scratch Resistance

Scratch resistance is tested with the Elcometer 3092. Tests the hardness of a coating by moving a tungsten carbide tip over the coating with a predetermined force. Ceiling tiles tested with 3.ON.



## Fire Resistance

METAL F-H 600 Swing EI30 fire resistant ceiling for corridors. Tested and classified to meet EI30 (a <-> b), in accordance with EN 13501-2.



## Impact Resistance

Ceiling panels installed in school corridors, gymnasiums and sports halls must withstand occasional abuse, including surface impact. Our specially adapted METAL R-H 200 Impact Resistance Solution can provide this durability feature (Class 1A).



## Clean Room

Healthcare, pharmaceutical, and the food processing industry expect the highest levels of air cleanliness. We designed our clean room metal ceiling tiles to meet these requirements for labs, data centres, and clean room assemblies.



## Exterior

Choose durability's finest from our selection of exterior solutions. These ceiling tiles are tested for wind uplift and corrosion resistance. We paired them with grids designed for outdoor use to create a complete system you can rely on to meet the demand of exterior performance.



## Seismic

Our seismic solutions give the extra security required for seismic resistance. Use our specially designed elements for maximum performance with minimised installation complexity.

# Colours & Finishes

Metal post-coated ceilings come in a wide array of colours and finishes, allowing for a lot of design flexibility. With so many colours and finishes to choose from, metal ceilings can be a great way to add visual interest, define a space, and create the desired atmosphere within your project. Besides standard colours, we can offer a wide range of RAL & NCS colours as well as performance coatings or visual effects.

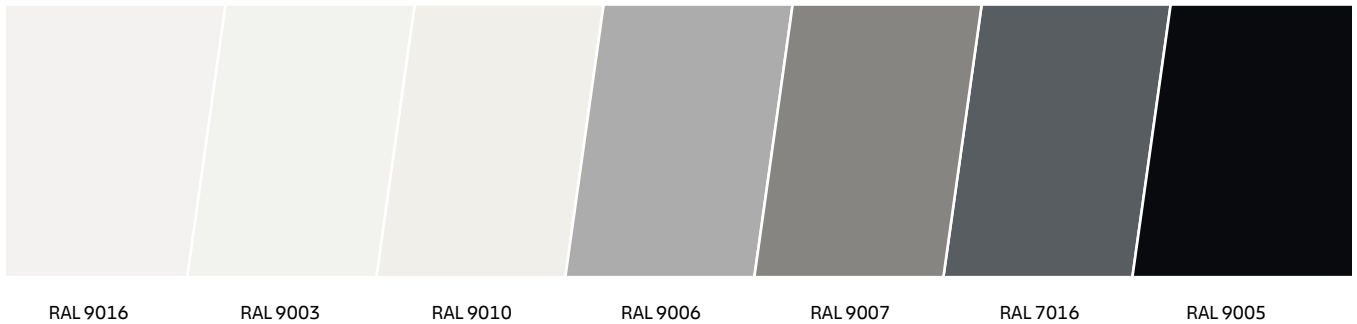

## 8 Colour Trends + Metal Approach = Unlimited Solutions

### Inspired by Nature

To enhance the spaces we work, live, play and heal in, we collaborated with design experts to create a stylish colour palette for our multi-material product portfolio. Choose from eight hues inspired by nature to create comfortable, well-balanced spaces that enhance occupant health and well-being.

[Your colour, your choice, your combination – your unlimited solutions.](#)

### The Best Combination Leads to the Best Solution

Set your creativity free by mixing and matching different colour combinations to create unlimited design possibilities.

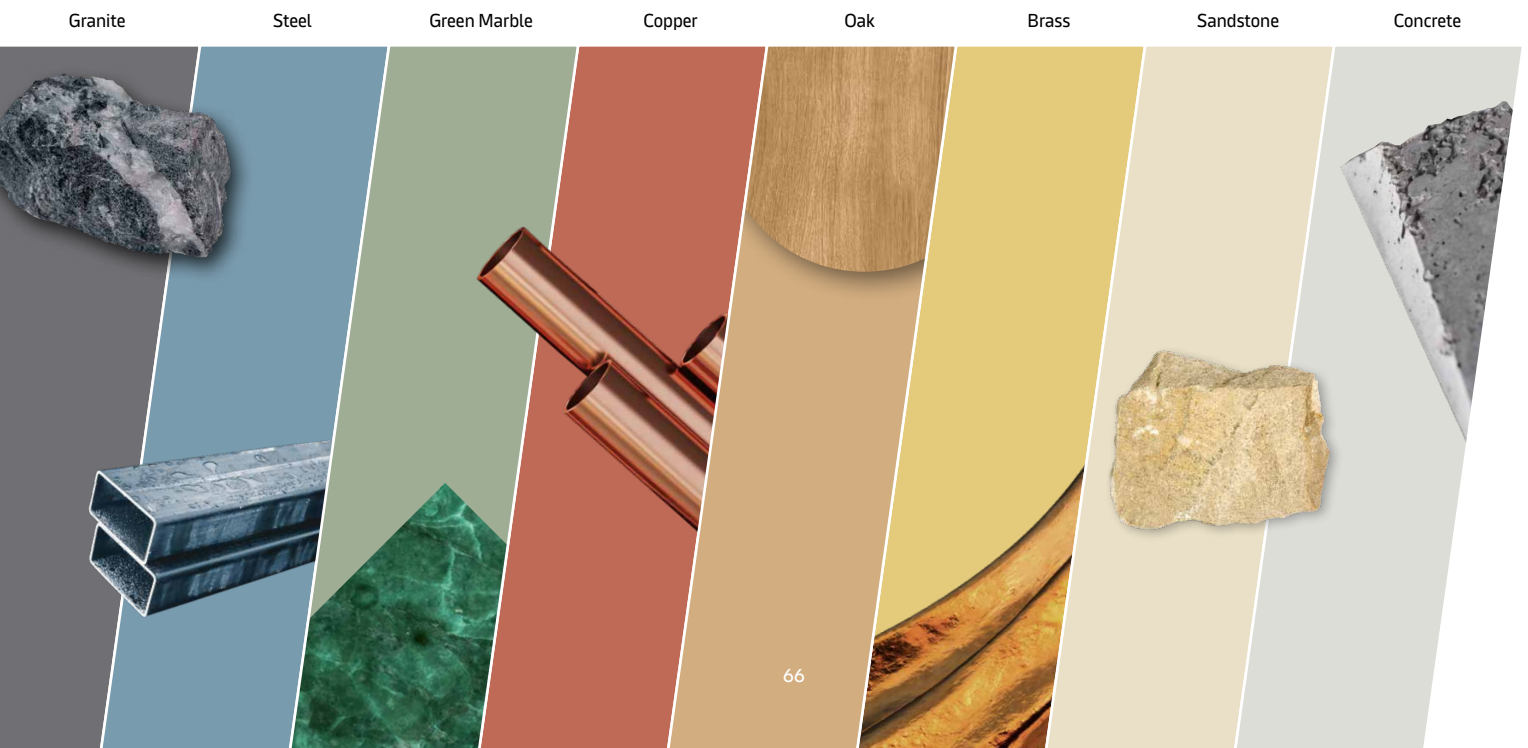



## Wood Effects

When the advantageous properties of two material worlds are combined in style, a truly unique design solution emerges: Ceilings with Metal Wood Effect from Knauf Ceiling Solutions. Through a high-quality printing process, the metal elements are given a specific wood finish, authentically reproducing the natural appearance of wood. Various wood veneers such as oak, ash, walnut, or maple are available. The Metal Wood Effect solutions benefit from the inherent, proven features of our metal range for ceiling and wall installations – durability, stability, edge detail, and a variety of perforations – to harmoniously blend with the distinctive beauty of wood.



Ash

Natural Bamboo

Caramel Bamboo

Maple

Oak

American Cherry

American Walnut

Further colours and wood effects available on request.

## METAL BioGuard

METAL BioGuard Tile Coating is designed for applications where suspended ceilings are required, and hygiene and cleanliness are of the utmost importance. METAL BioGuard is more effective in the control of bacteria than a standard powder coating because it prevents the settlement of bacteria on the surface of the tile. METAL BioGuard gives good cleanability and resistance to disinfectants as well as cleanroom performance.

For more information, please get in touch with us.



Split Airport, Croatia © Miljenko Hegečić

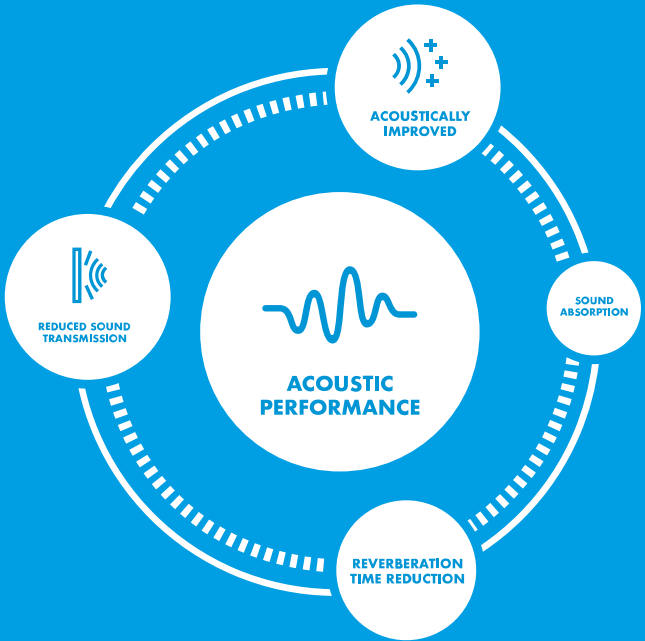

# Create quieter spaces with acoustic ceilings to think out loud

We provide acoustic ceilings for every space, with ceilings that are as pleasing to the eye as they are to the ear. High sound absorption, high flanking transmission or a perfect balance of both, our high performing acoustical offer can help optimise comfort, intelligibility and privacy to focus the mind and collaborate more effectively.

## Weighted Sound Absorption Coefficient, $\alpha_w$

A single-number rating for random incidence sound absorption coefficients calculated by reference to EN ISO 11654. With this method measured values obtained in accordance with EN ISO 354, are converted into octave bands at 250, 500, 1000, 2000 and 4000 Hz and are plotted onto a graph. A standard reference curve is then shifted towards the measured values in steps of 0.05 until a "best fit" is obtained. The derived value of  $\alpha_w$  will vary between 0.00 and 1.00 but is only expressed in multiples of 0.05, e.g.  $\alpha_w = 0.65$ .

## Shape Indicator

With reference to EN ISO 11654, the calculated value of  $\alpha_w$  may be qualified by one or more letters (in brackets) to indicate if the product has excess sound absorption at low (L), medium (M) or high (H) frequencies.

## Sound Absorption Class

With reference to EN ISO 11654, the calculated value of  $\alpha_w$  may additionally be allocated into one of six descriptive classes in accordance with the following table:

Sound Absorption Class	$\alpha_w$
A	0.90, 0.95, 1.00
B	0.80, 0.85
C	0.60, 0.65, 0.70, 0.75
D	0.30, 0.35, 0.40, 0.45, 0.50, 0.55
E	0.15, 0.20, 0.25
Not classified	0.00, 0.05, 0.10

## Weighted Suspended Ceiling Normalised Flanking Transmission Level Normalised, $D_{n,f,w}$

A single-number rating of the laboratory measurement of room-to-room (horizontal) airborne flanking sound transmission of a suspended ceiling above adjacent rooms sharing a common ceiling plenum. It is determined in accordance with EN ISO 717-1 from measurements made in accordance with EN ISO 10848-2.

## Weighted Sound Reduction Index, $R_w$

A single-number rating of the laboratory measurement of (vertical) airborne sound reduction of a suspended ceiling. It is determined by reference to EN ISO 717-1 from measurements of sound reduction index made in accordance with EN ISO 140-3.

## Noise Reduction Coefficient, NRC

A single-number descriptor of random incidence sound absorption coefficients. Defined in ASTM C423-01 as the arithmetical average, to the nearest multiple of 0.05, of the measured sound absorption coefficients for the four one-third octave band centre frequencies of 250, 500, 1,000 and 2,000 Hz.

## Ceiling Attenuation Class, CAC

A single-number rating, expressed in decibels, of the laboratory measured frequency dependend room-to-room sound attenuation of a ceiling sharing a common ceiling plenum above adjacent rooms. It is determined by reference to ASTM E 413 from measurements of normalised ceiling attenuation made in accordance with ASTM E 1414 over the one-third octave band frequency range 125 - 4000 Hz. This USA based system is principally used in North America and Australia but references to it may also be seen in Europe. CAC is similar but not identical to Weighted Suspended Ceiling Normalised Flanking Transmission Level Difference  $D_{n,f,w}$ .

## Sound Reduction

A term used in relation to the vertical transmission of sound through a suspended ceiling.

## Sound Attenuation

A term used in relation to the horizontal transmission of sound through a suspended ceiling above adjacent rooms that share a common ceiling plenum.

## Equivalent Absorption Area (EAA)

The equivalent absorption is a measure of the total sound absorption by discrete objects (canopies, screens, furniture, etc.) when installed in an architectural space. Because these types of absorbers have more than one surface and may be irregular in form, it is not meaningful to assign sound absorption coefficients to them. Hence the Equivalent Absorption Area per unit (measured in Sabines) is preferred to characterise the absorption provided by an individual 'space absorber' such as METAL Sonic Element canopies.

# Acoustic Solutions – Standard Options

Knauf Ceiling Solutions offer a range of popular perforation patterns and standard acoustic infill options.

## Black Acoustic Fleece VLSRX



The standard VLSRX black non-woven acoustic fleece provides a cost-effective solution for metal ceiling tiles to meet general sound absorption requirements.

Bonded to the back of the perforated metal tile the non-woven fleece helps to eliminate pattern staining on the surface of the tile that can be associated with loose-laid or non-bonded solutions.

In addition to the standard perforations shown on the next page, there is a wide range of Vario Design perforations available, as well as additional acoustic solutions, to meet a broader range of performance requirements.

## Rg 0704 Optimicro Perforation

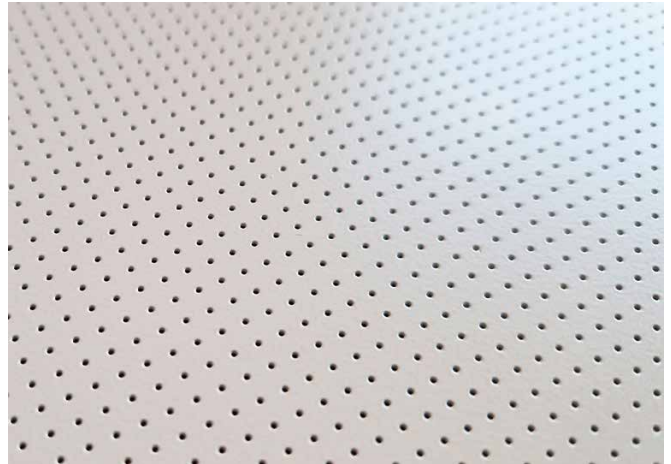

The Rg 0704 Optimicro perforation utilises the optimum ratio between perforation diameter and the open surface area to achieve our highest acoustic performance when combined with a black acoustic fleece.

Not only does Optimicro perforation provide great acoustics, thanks to the small diameter and low open area it also has a brighter, whiter appearance with high light reflectance that can help to contribute to reducing energy costs in buildings.

## Perforation Description

The following product prefixes describe the shape and arrangement of perforations:

- Rd = Round perforations, 45° diagonal pitch
- Rg = Round perforations, 90° straight pitch
- Rv = Round perforations, various angle pitches
- Qg = Square perforations, 90° straight pitch
- Qd = Square perforations, 45° diagonal pitch
- Lg = Slotted perforations, 90° straight pitch
- Tv = Diamond perforations, various angle pitches

The numbers define the perforation size and free area.

The first two, and occasionally three, numbers denote the hole diameter in tenths of millimetres, while the last two digits represent the proportion of free cross-sectional area.

Example: Rg 2516 = round perforation, 90 straight pitch or

Rg 2516 indicates a round perforation with a 90 degree straight pitch, a hole diameter of 2.5 mm, and free cross-section of 16%.

## Unperforated

Without acoustic infill

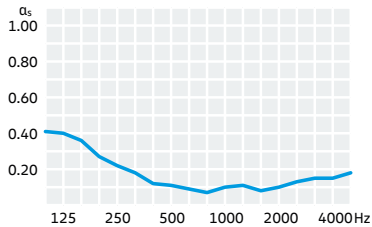
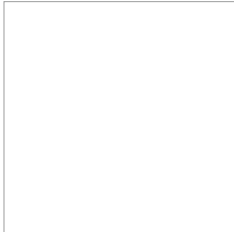

## Rg 0701 Extramicro Perforation

1.5% open area, over border perforated, for a steel gauge of max. 0.7 mm

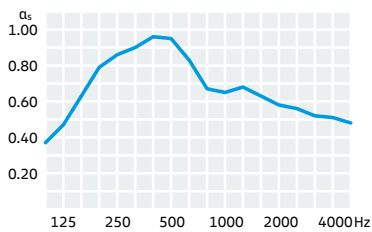
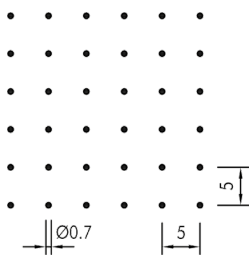

## Rg 0704 Optimicro Perforation

4% open area, over border perforated, for a steel gauge of max. 0.7 mm

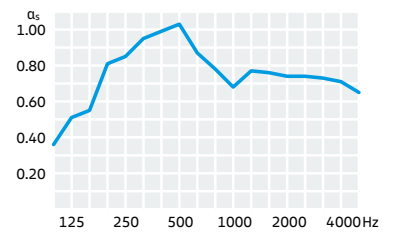
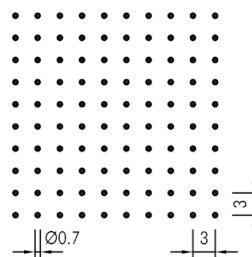

## Rd 1522 Micro Perforation

22% open area, unperforated border, for a steel gauge of max. 1.25 mm

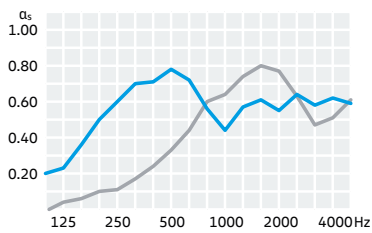
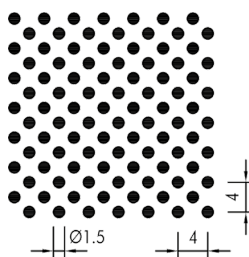

## Rg 2516 Standard Perforation

16% open area, unperforated border, for a steel gauge of max. 1.0 mm

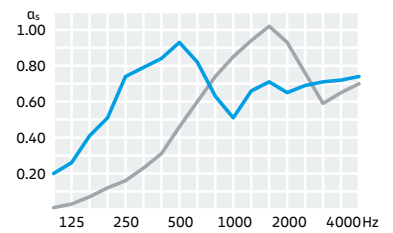
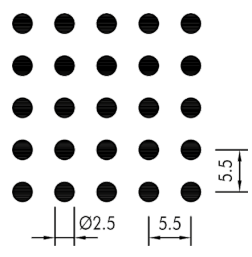

Perforation	Acoustic infill	EN ISO 354										EN ISO 10848-2	EN ISO 10140-2	CAC [dB]
		$\alpha_w$	Cavity [mm]	Class	Frequency [Hz] $\alpha_w$						NRC	$D_{n,w}$ [dB]	$R_w$ [dB]	
					125	250	500	1000	2000	4000				
Unperforated	-	<b>0.10(L)</b>	200	NC	0.40	0.20	0.10	0.10	0.10	0.15	<b>0.15</b>	<b>34</b>	<b>19</b>	<b>35</b>
Rg 0701	VLSRX	<b>0.65(LM)</b>	200	C	0.50	0.85	0.90	0.65	0.60	0.50	<b>0.75</b>	<b>19</b>	<b>10</b>	<b>20</b>
Rg 0704	VLSRX	<b>0.80(L)</b>	200	B	0.45	0.85	0.95	0.75	0.75	0.70	<b>0.85</b>	<b>19</b>	<b>10</b>	<b>19</b>
Rd 1522	VLSRX	<b>0.60</b>	200	C	0.25	0.60	0.75	0.60	0.50	0.60	<b>0.60</b>	<b>14</b>	<b>6</b>	<b>15</b>
		<b>0.40(MH)</b>	60	D	0.05	0.15	0.35	0.65	0.75	0.55	<b>0.45</b>			
Rg 2516	VLSRX	<b>0.70</b>	200	C	0.30	0.70	0.85	0.60	0.70	0.70	<b>0.70</b>	<b>16</b>	<b>6</b>	<b>16</b>
		<b>0.45(MH)</b>	60	D	0.05	0.15	0.45	0.85	0.90	0.65	<b>0.60</b>			

$\alpha_w$ : as per EN ISO 11654 / NRC: as per ASTM C 423-01 /  $D_{n,w}$ : as per EN ISO 717-1 / CAC: as per ASTM E 413-10  
60 mm cavity for wall solutions

# Acoustic Solutions – Additional Options

In addition to the standard VLSRX black acoustic fleece, Knauf Ceiling Solutions offers a range of premium infill acoustic solutions to meet higher acoustic demands. These solutions prevent pattern staining or filter effects from incorrectly fitted loose acoustic pads.

Premium infill solutions are factory-fitted to the back of standard metal ceilings with VLSRX black acoustic fleece to create an easy to install “out-of-the-box” solution, staying perfectly in position during installation and any subsequent access or maintenance. For standard ceiling tiles and modules, the premium infills are bonded to the reverse of the VLSRX non-woven fleece.

For the Vario Design range of configurable rectangular panels and additional edge details mechanical fixing tabs ensure the premium infills remain in place.



There are two options available in the premium infills range:

## Premium OP15



The Premium OP15 solution uses a 15 mm thick medium-low density mineral infill that is designed to maximise the sound absorption performance with up to Class A performance possible.

## Premium B17



The Premium B17 infill uses a 17mm thick, higher density infill when higher attenuation performance is required – achieving up to 44 dB  $D_{n,f,w}$  for unperforated tiles. Even with perforated tiles, up to 41 dB  $D_{n,f,w}$  can be achieved using Premium B17 infills, whilst maintaining up to 0.75  $\alpha_w$  sound absorption to provide a balanced acoustic performance.

Further acoustic infill options are available on request.

## Unperforated

Without acoustic infill

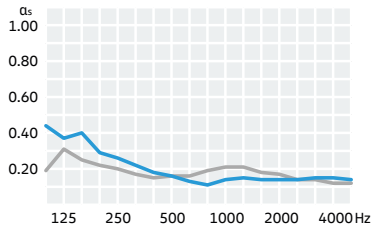
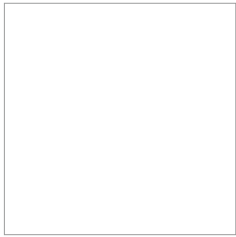

## Rg 0701 Extramicro Perforation

1.5% open area, over border perforated, for a steel gauge of max. 0.7 mm

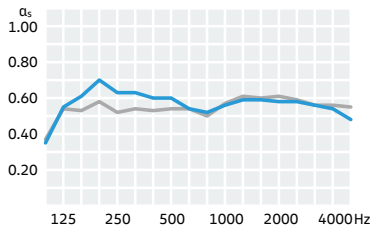
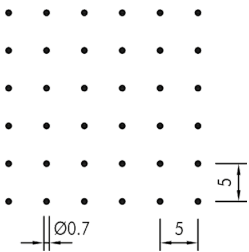

## Rg 0704 Optimicro Perforation

4% open area, over border perforated, for a steel gauge of max. 0.7 mm

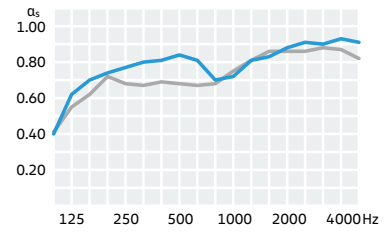
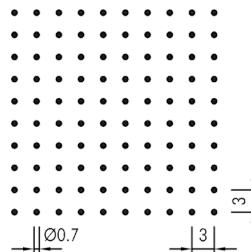

## Rd 1522 Micro Perforation

22% open area, unperforated border, for a steel gauge of max. 1.25 mm

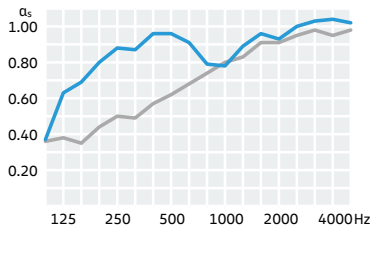
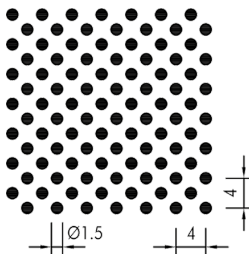

## Rg 2516 Standard Perforation

16% open area, unperforated border, for a steel gauge of max. 1.0 mm

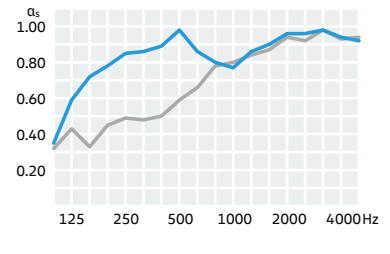
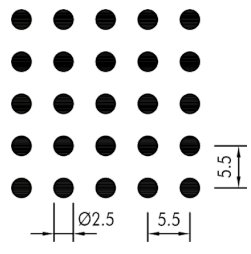

Perforation	Acoustic infill	EN ISO 354										EN ISO 10848-2	EN ISO 10140-2		
		$\alpha_w$	Cavity [mm]	Class	Frequency [Hz] $\alpha_p$						NRC	$D_{n,f,w}$ [dB]	$R_w$ [dB]	CAC [dB]	
					125	250	500	1000	2000	4000					
Unperforated	Premium OP15	0.15(L)	200	NC	0.40	0.25	0.15	0.15	0.15	0.15	0.15	0.20	43	23	45
	Premium B17	0.20	200	E	0.25	0.20	0.15	0.20	0.15	0.15	0.20	44	23	45	
Rg 0701	Premium OP15	0.65(L)	200	C	0.50	0.65	0.60	0.55	0.60	0.55	0.60	27	16	28	
	Premium B17	0.60	200	C	0.50	0.55	0.55	0.55	0.60	0.55	0.55	41	20	43	
Rg 0704	Premium OP15	0.80	200	B	0.55	0.75	0.80	0.75	0.85	0.90	0.80	27	16	28	
	Premium B17	0.75	200	C	0.55	0.70	0.70	0.75	0.80	0.80	0.75	41	20	42	
Rd 1522	Premium OP15	0.90	200	A	0.55	0.85	0.95	0.80	0.95	1.00	0.90	24	13	25	
	Premium B17	0.70(H)	200	C	0.35	0.50	0.60	0.80	0.90	0.95	0.70	30	16	31	
Rg 2516	Premium OP15	0.90	200	A	0.55	0.85	0.90	0.80	0.95	0.95	0.90	24	13	25	
	Premium B17	0.65(H)	200	C	0.35	0.45	0.60	0.80	0.90	0.95	0.70	31	16	32	

$\alpha_w$ : as per EN ISO 11654 / NRC: as per ASTM C 423-01 /  $D_{n,f,w}$ : as per EN ISO 717-1 / CAC: as per ASTM E 413-10

# Vario Design Perforations

Knauf Ceiling Solutions offers an extensive range of more than 40 perforations, providing a wide choice of aesthetic options: large apertures for specialised uses such as airflow or loudspeakers to slotted perforations for a more linear appearance. Below is a sample of the possibilities at your reach. For more information, please get in touch with us.

## Acoustic values

Perforation	Acoustic infill	EN ISO 354										EN ISO 10848-2	EN ISO 10140-2	
		$\alpha_w$	Cavity [mm]	Class	Frequency [Hz] $\alpha_p$						NRC	$D_{n,f,w}$ [dB]	$R_w$ [dB]	CAC [dB]
					125	250	500	1000	2000	4000				
Rg 0501	-	0.45(L)	200	D	0.25	0.65	0.65	0.40	0.40	0.35	0.55	-	-	-
Rd 1506	VLSRX	0.75(LM)	200	C	0.40	0.85	1.00	0.70	0.65	0.60	0.80	-	-	-
Rg 1511 / Rd 1511	VLSRX	0.65	200	C	0.30	0.65	0.85	0.60	0.65	0.65	0.70	14	6	15
Rg 1821	VLSRX	0.60	200	C	0.25	0.55	0.75	0.55	0.60	0.60	0.60	13	6	14
Rg 3013 / Rd 3013	VLSRX	0.75	200	C	0.35	0.75	0.95	0.70	0.75	0.70	0.75	14	6	15
		0.50(MH)	60	D	0.05	0.20	0.55	0.95	0.90	0.65	0.65			
Rv 4058	VLSRX	0.50	200	D	0.20	0.50	0.65	0.40	0.50	0.55	0.50	-	-	-
Rg 14023	VLSRX	0.75(LM)	200	C	0.40	0.85	1.00	0.70	0.75	0.65	0.80	-	-	-
		0.55(MH)	60	D	0.05	0.25	0.60	1.00	0.95	0.60	0.70			
Rg 25020	VLSRX	0.65(LM)	200	C	0.45	0.90	1.00	0.75	0.65	0.50	0.80	-	-	-
		0.55(M)	60	D	0.10	0.25	0.65	0.95	0.75	0.50	0.70			
Qg 4025	VLSRX	0.70	200	C	0.30	0.70	0.90	0.65	0.70	0.70	0.70	14	8	15
Qg 10565	VLSRX	0.60	200	C	0.25	0.55	0.75	0.50	0.60	0.55	0.60	-	-	-
Tv 26845	VLSRX	0.65	200	C	0.30	0.65	0.80	0.55	0.65	0.60	0.65	-	-	-

$\alpha_w$ : as per EN ISO 11654 / NRC: as per ASTM C 423-01 /  $D_{n,f,w}$ : as per EN ISO 717-1 / CAC: as per ASTM E 413-10  
60 mm cavity for wall solutions



### Rg 0501

0.64 % open area, over border perforated for a steel gauge of max. 0.5 mm

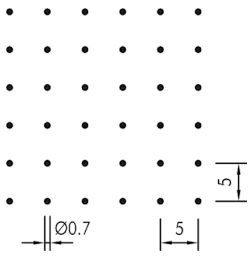

### Rd 1506

6% open area, unperforated border for a steel gauge of max. 1.25 mm

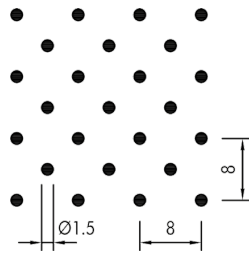

### Rg 1821

21% open area, unperforated border for a steel gauge of max. 0.7 mm

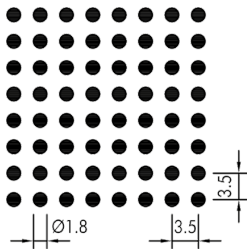

### Rg 3013

13% open area, unperforated border for a steel gauge of max. 1.0 mm

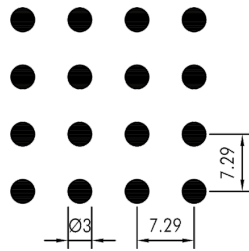

### Rg 1511

11% open area, unperforated border for a steel gauge of max. 1.25 mm

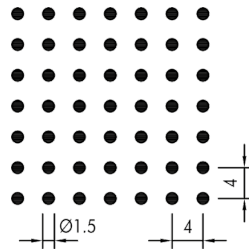

### Rd 1511

11% open area, unperforated border for a steel gauge of max. 1.0 mm

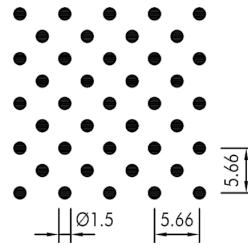

### Rg 14023

23% open area, unperforated border for a steel gauge of max. 1.0 mm

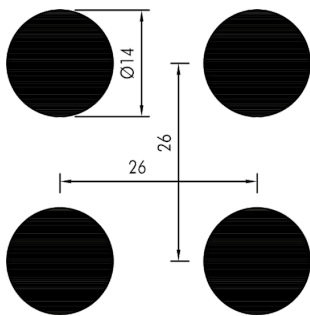

### Qg 4025

25% open area, unperforated border for a steel gauge of max. 0.7 mm

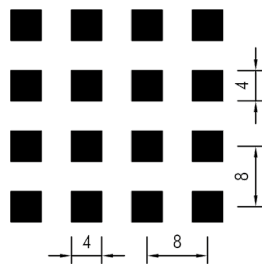

### Rd 3013

13% open area, unperforated border for a steel gauge of max. 1.0 mm

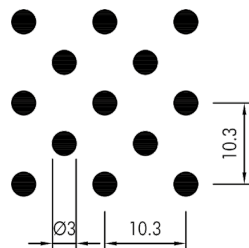

### Rv 4058

58% open area, unperforated border for a steel gauge of max. 0.7 mm

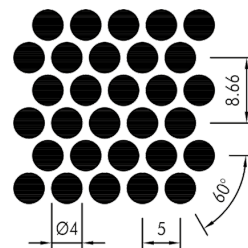

### Qg 10565

65% open area, unperforated border for a steel gauge of max. 0.8 mm

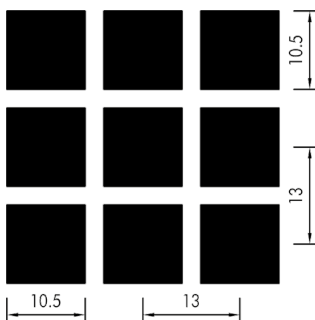

### Tv 26845

45% open area, unperforated border for a steel gauge of max. 0.8 mm

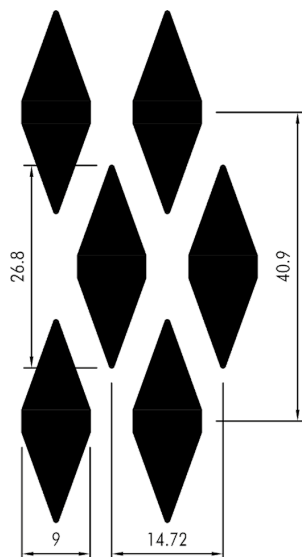

### Rg 25020

20% open area, unperforated border for a steel gauge of max. 1.0 mm

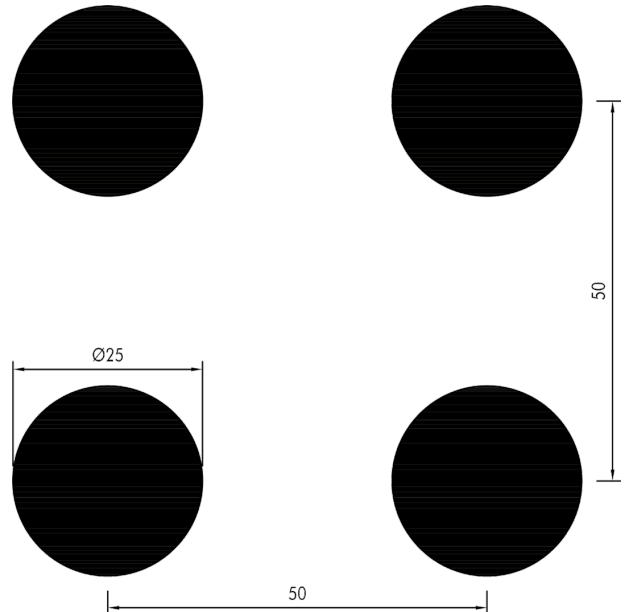

# Definition of Technical Performance Icons



## Sound Absorption

A single-number rating for random incidence sound absorption coefficients as calculated by reference to EN ISO 11654 ( $\alpha_w$ ) or to ASTM C 423-01 (NRC).



## Fire Reaction

Reaction to fire classification in accordance with EN 13501-1 expressed as Euroclass (A1 – F).



## Humidity Resistance

Maximum relative humidity conditions for installation and lifetime of ceiling.



## Flanking Transmission Level

A single-number rating for flanking sound transmission between adjacent rooms, as calculated by reference to EN ISO 717-1.



## Weight

Weight per unit area of the product (kg/m<sup>2</sup>)



## Antimicrobial

Antimicrobial finish on standard metal tiles and available as a custom option.



## Light Reflectance

Light reflection is the proportion of incident light that is reflected back off the product.



## Scratch Resistance

Solutions with this icon offer a superior level of surface scratch resistance.



## Colours

Colours available for products with this icon.



## Recycled Content

The recycled content of the product, as calculated in accordance with ISO 14021.



## EPD (Environmental Product Declaration)

Independently verified and registered documents that communicate transparent and comparable information about the life-cycle environmental impact of products. Knauf Ceiling Solutions EPDs have been third party certified by IBU (Institut Bauen und Umwelt e.V. (IBU) as conforming to the requirements of ISO 14025.



## Cradle To Cradle CERTIFIED®

Products with this icon are Cradle-to-Cradle CERTIFIED®, providing a transparent mechanism to compare the sustainability performance of products, showing that they are designed for recycling and helping to protect and to sustain our environment for future generations by keeping resources in the economy for a longer period of time.



## VOC

The VOC emission performance in accordance with the French labelling requirements.



## Formaldehyde (E1)

Formaldehyde emission level (E1 = lowest test result possible).



## Indoor Air Comfort Gold

Higher level "Indoor Air Comfort GOLD - Certified Product" shows additional compliance of product emissions with the criteria of many of the voluntary specifications issued by most relevant ecolabels and similar specifications in the EU an requirements for sustainable building certifications. Certified products are those with the best-in-class low emissions, thus good for indoor air quality.



## ISO 9001 & ISO 14001

This icon demonstrates Knauf Ceiling Solutions ability to consistently provide products and services that meet customer and regulatory quality management system requirements (ISO 9001) and environmental management system requirements (ISO 14001).

## Cleaning

The frequency and cleaning method of a ceiling varies from one application to another. All products can at least be cleaned with a dry cloth or vacuum cleaner.



### Dry Cleaning

For standard cleaning of dust, loose dirt or deposit, a soft brush, a clean, dry, soft white cloth, a normal vacuum cleaner with a soft brush or focus compressed air can be used.



### Moist Cleaning

For more intensive cleaning, the surfaces can be damp cleaned. This should be carried out with a wrung-out soft cloth or sponge. After cleaning, the surfaces of the tile should be dried with a soft cloth.

Justice Centre Zaragoza, Spain  
© José Manuel Cutillas

## CE Marking

In Europe, the Construction Products Regulations (305/2011/EU) defines basic requirements for products (and projects) such that they are safe and fit for their intended use. Harmonized Product Standards respond to these essential requirements and set out what tests must be conducted and how the performance must be communicated. For suspended ceilings the applicable product standard is EN 13964:2014 Suspended Ceilings – Requirements & Test Methods.

The essential requirements identified for suspended ceiling membranes (tiles & baffles) include:

- Reaction to Fire (mandatory)
- Formaldehyde Emissions (mandatory)
- Sound Absorption
- Flexural Tensile Strength / Durability
- Thermal conductivity

It is mandatory to CE Mark products within the scope of EN 13964 and provide a Declaration of Performance in order to place the product on the market.

All Knauf Ceiling Solutions Declarations of Performance can be found on the Knauf Ceiling Solutions website.

Zürich Train Station,  
Passage Sihlquai, Exit Europaallee,  
Zürich, CH  
© Foto Lautenschlager



Paddington Train Station,  
London, UK  
© Philip Durrant



Blake House, UK  
© Philip Durrant



***Build on us.***

***Build on us.***

**Knauf Ceilings Holding GmbH**

Am Bahnhof 7  
97346 Iphofen, Germany  
Phone: +49 9323 31-0  
E-Mail: zentrale@knauf.com  
www.knauf.com

Commercial Register: District Court, Würzburg  
Registration No.: HRA 6031  
VAT No. pursuant to § 27a of the German VAT Act  
(Umsatzsteuergesetz): DE317846056  
Board of Directors: Lars Klodwig, Karl Wenig, Daniel Wolf