

Armstrong PRELUDE 35 XL²

Exposed 35 mm grid system - System C

Key features

- Peakform : patented design for strength, stability and easier to cut
- Superlock clip: secure Main Runner connection for better alignment and easier to connect
- Rotary stitched: strength and extra stability

Application areas

- Healthcare / Classrooms / Meeting rooms / Individual offices

Physical data

- Material: galvanised steel
- Surface finish: baked polyester paint
- Colour: all products standard in Global White
- Other standard colours available on popular items

Armstrong PRELUDE 35

Universal Peakform Main Runners & Superlock Clip (bulb-to-bulb connection)

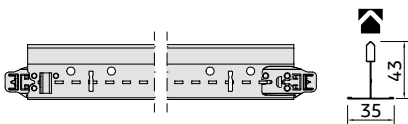



| Item reference | Dimensions (mm) | | | Slot centres | Content/carton | | Weight/carton kg | Cartons/pallet |
|--|-----------------|-------|--------|--------------|----------------|------|------------------|----------------|
| | Length | Width | Height | | pcs | lm | | |
|  24 40 42 * | 3600 | 35 | 43 | 100 | 16 | 57.6 | 22.20 | 20 |

* Black (BK) & galvanised as standard colours available. Special colours on request.

Armstrong PRELUDE 35

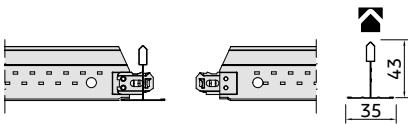
XL² Cross Tees (stab system - joggled)



| Item reference | Dimensions (mm) | | | Slot centres | Content/carton | | Weight/carton kg | Cartons/pallet |
|--|-----------------|-------|--------|--------------|----------------|------|------------------|----------------|
| | Length | Width | Height | | pcs | lm | | |
| Cross Tees - Slotted | | | | | | | | |
|  24 30 42 * | 1200 | 35 | 43 | 600 | 36 | 43.2 | 15.00 | 60 |
| Cross Tees - Unslotted | | | | | | | | |
| 24 06 42 * | 1990 | 35 | 43 | - | 16 | 31.8 | 15.00 | 20 |
| 24 36 42 * | 1500 | 35 | 43 | - | 32 | 48.0 | 16.60 | 20 |
| 24 20 42 * | 600 | 35 | 43 | - | 36 | 21.6 | 7.50 | 120 |

* Black (BK) & galvanised as standard colours available. Special colours on request.

Section Drawings

Armstrong PRELUDE 35

Universal Peakform Main Runners & Superlock Clip (bulb-to-bulb connection)

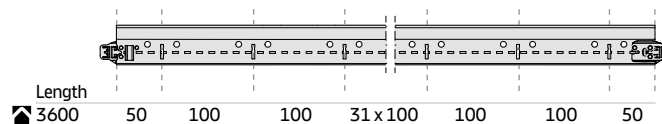

Armstrong PRELUDE 35

XL² Cross Tees (stab system - joggled)



System Drawing - System C

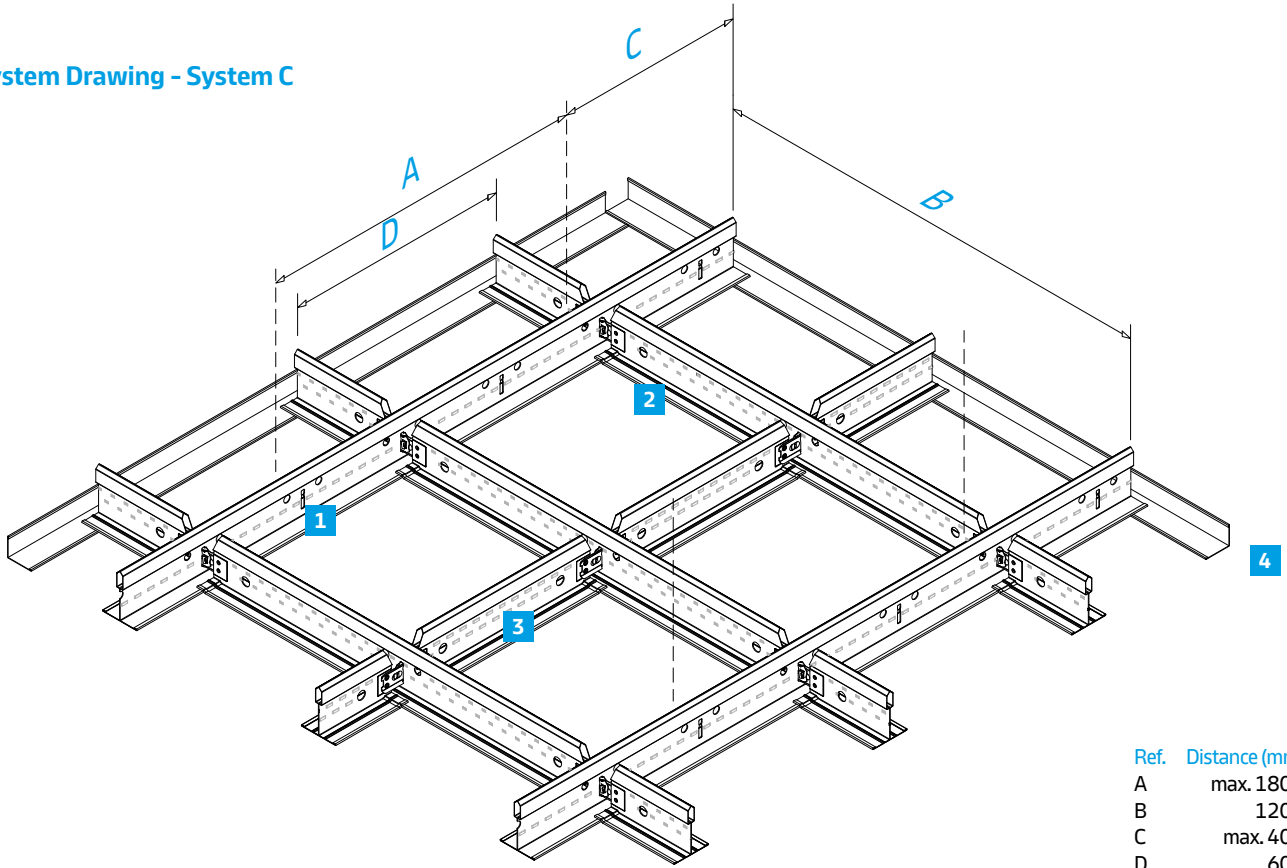

Material required per m² (no waste included)

| No. | Description | Item reference | Module 600 x 600 | Module 1200 x 600 |
|-----|-----------------|----------------|---|-------------------|
| 1 | Main Runner | 24 40 42 | 0.84 lm | 0.84 lm |
| 2 | Long Cross Tee | 24 30 42 | 1.67 lm | 1.67 lm |
| 3 | Short Cross Tee | 24 20 42 | 0.84 lm | - |
| 4 | Perimeter trim | - | Dependent on room dimensions (approx. 0.6 lm/m ²) | |
| | Hanger | - | 0.70 pcs | 0.70 pcs |
| | Retaining Clip | - | 5.56 pcs | 5.56 pcs |
| | Tiles | - | 2.78 pcs | 1.39 pcs |

Load Table







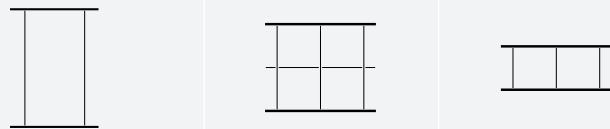

Maximum permissible weight (kg/m²)

| Main Runner distances | 1990 mm | 1500 mm | 1200 mm | 600 mm |
|------------------------|------------------|------------------|--------------------------|--------------------------|
| Hanger distance A (mm) | Module 1990x1000 | Module 1500x1000 | Module 600x600, 1200x600 | Module 600x600, 1200x600 |
| 800 | 3.2 | 8.0 | 21.2 | 25.0 |
| 1000 | 3.0 | 7.9 | 15.9 | 25.0 |
| 1200 | 2.6 | 6.7 | 11.0 | 22.0 |
| 1500 | - | 4.3 | 6.7 | 13.8 |
| 1800 | - | 2.4 | 3.5 | 7.9 |

Note:
The load per m² must be evenly distributed (no extra point loads). After loading, the deflection will remain within the permitted deflection according to class 1 (L/500) of EN 13964, provided the grid is laid out as shown.



For other grid layouts, load capacities or hanger distances, please contact Knauf Ceiling Solutions.

| Characteristics | Detailed information | |
|---|---|--|
| Fire reaction  | Euroclass A1 as per EN 13501-1 | |
| Indoor air quality  |  A+ |  ISO 3 |
| Cleanability |  |  |
| Sustainability |  up to 25% |  EPD  full scope |

All measurements in millimetres. All sizes are nominal.
 Cross Tee alignment is achieved by locating the tees to the left-hand side of the adjoining section.

Products may vary from country to country. Please contact your local sales representative.
 For further information and legal notice, please visit our website.