

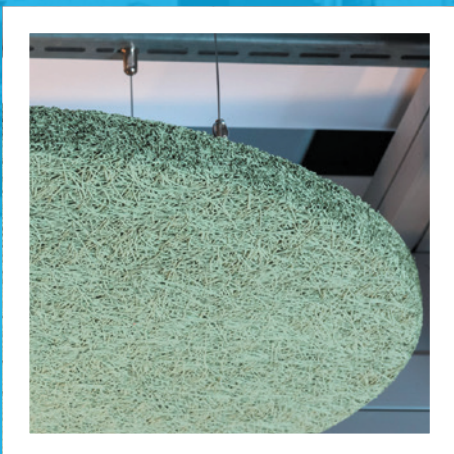

















Островни системи  
**HERADESIGN® Sonic Element**  
Индивидуални / Групирани

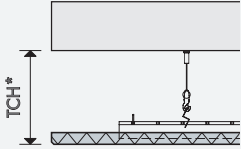

- HERADESIGN® Sonic Element е декоративен акустичен остров от дървесна вата, който предлага неограничени възможности за дизайн
- HERADESIGN® Sonic Element е наличен в структура HERADESIGN® Superfine
- Доставка се предварително сглобен за лесен и бърз монтаж
- Възможни са цветовете Vario Design по RAL и NCS
- Комплекта включва носеща конструкция и окачвачи



Островни системи  
**HERADESIGN® Sonic Element**  
 Индивидуални / Групирани

<b>Структура</b> 	<b>HERADESIGN® Superfine</b> 																																															
<b>Дебелина (мм)</b> 	35																																															
<b>Размери (мм)</b> 	HERADESIGN® Sonic Element кръг : Ø 1200мм HERADESIGN® Sonic Element квадрат: 1200 x 1200мм HERADESIGN® Sonic Element шестостен: 1200 x 1040мм																																															
<b>Система на окачване</b> 	Комплекта съдържа носеща конструкция и окачвачи Лесен и бърз монтаж с четири въжени окачвача Дължина на въжето 1000мм Окачване на U- профил с възможност за групиране по желание																																															
<b>Тегло</b> 	HERADESIGN® Sonic Element кръг : 19.4 кг/бр HERADESIGN® Sonic Element квадрат: 24.8 кг/бр HERADESIGN® Sonic Element шестостен: 16.2 кг/бр																																															
<b>Цветове</b> 	<b>Стандартни цветове</b>  Бял Близък до RAL 9010  Бежов Естествен цвят 13	<b>Цветове Vario Design</b>  Гранит    Стотана    Зелен Мрамор    Мед    Дъб    Месинг    Пясъчник    Бетон <ul style="list-style-type: none"> <li>• Възможни са и други цветове от популярните RAL и NCS системи за оцветяване.</li> <li>• Отклонения в цвета и външния вид могат да възникнат поради грубата структура на паната.</li> </ul>																																														
<b>Звукопоглъщане</b> 	<table border="1"> <thead> <tr> <th rowspan="2">Остров [мм]</th> <th rowspan="2">TCH* [мм]</th> <th colspan="6">Еквивалентна абсорбираща площ A<sub>0b</sub> [m<sup>2</sup>]</th> </tr> <tr> <th colspan="6">Честота [Hz], α<sub>p</sub></th> </tr> <tr> <th></th> <th></th> <th>125</th> <th>250</th> <th>500</th> <th>1000</th> <th>2000</th> <th>4000</th> </tr> </thead> <tbody> <tr> <td>HERADESIGN® Sonic Element кръг</td> <td>200</td> <td>0.20</td> <td>0.60</td> <td>0.90</td> <td>0.70</td> <td>1.10</td> <td>1.40</td> </tr> <tr> <td>HERADESIGN® Sonic Element квадрат</td> <td>200</td> <td>0.10</td> <td>0.70</td> <td>1.10</td> <td>0.90</td> <td>1.40</td> <td>1.70</td> </tr> <tr> <td>HERADESIGN® Sonic Element шестостен</td> <td>200</td> <td>0.10</td> <td>0.50</td> <td>0.70</td> <td>0.70</td> <td>1.00</td> <td>1.20</td> </tr> </tbody> </table>  <p>* обща височина на окачване</p>		Остров [мм]	TCH* [мм]	Еквивалентна абсорбираща площ A <sub>0b</sub> [m <sup>2</sup> ]						Честота [Hz], α <sub>p</sub>								125	250	500	1000	2000	4000	HERADESIGN® Sonic Element кръг	200	0.20	0.60	0.90	0.70	1.10	1.40	HERADESIGN® Sonic Element квадрат	200	0.10	0.70	1.10	0.90	1.40	1.70	HERADESIGN® Sonic Element шестостен	200	0.10	0.50	0.70	0.70	1.00	1.20
Остров [мм]	TCH* [мм]	Еквивалентна абсорбираща площ A <sub>0b</sub> [m <sup>2</sup> ]																																														
		Честота [Hz], α <sub>p</sub>																																														
		125	250	500	1000	2000	4000																																									
HERADESIGN® Sonic Element кръг	200	0.20	0.60	0.90	0.70	1.10	1.40																																									
HERADESIGN® Sonic Element квадрат	200	0.10	0.70	1.10	0.90	1.40	1.70																																									
HERADESIGN® Sonic Element шестостен	200	0.10	0.50	0.70	0.70	1.00	1.20																																									
<b>Реакция на огън</b> 	Euroclass <b>B-s1,d0</b> според EN 13501-1																																															
<b>Влагоустойчивост</b> 	Не е подходящ за монтаж в закрити плувни басейни или спа зони.																																															
<b>Почистване</b>  																																																
<b>Дълговечност</b>																																																

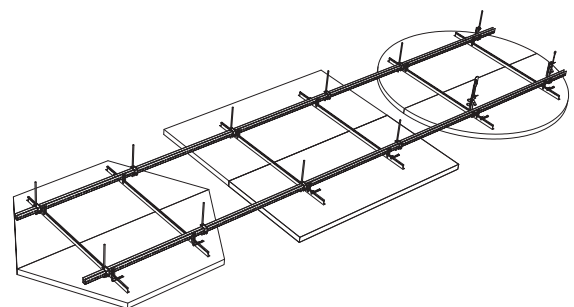
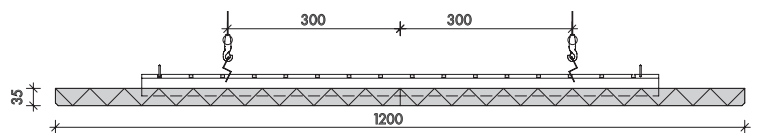
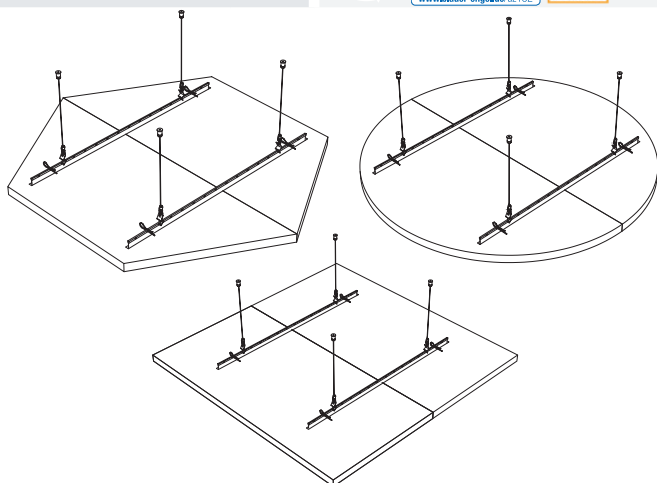

[Предидшна страница] HERADESIGN® Sonic Element (© Knauf Ceiling Solutions)

**vb** Опциите са тази икона са налични в серия **Vario Design**. Някои комбинации от цветовете не са възможни за всеки продукт. Продуктите варират от страна в страна. Моля свържете се с Вашия местен представител. За повече информация и правна рамка, моля посетете нашата интернет страница. [knaufceilingsolutions.com](http://knaufceilingsolutions.com)

09 / 2022

**KNAUF**CEILING  
Solutions