



















**KNAUF**CEILING  
Solutions

## ТЕХНИЧЕСКА КАРТА HERADESIGN® Sky Line

HERADESIGN® Sky Line е профил от анодизиран алуминий, който може да бъде монтиран по страните на остров HERADESIGN®.

- HERADESIGN® Sky Line е подходящ за пана в структури HERADESIGN® Superfine, Fine, Macro, Micro или Plano
- Лесен и бърз монтаж



		HERADESIGN® Fine, Fine A2	HERADESIGN® Superfine, Superfine A2	HERADESIGN® Micro	HERADESIGN® Macro	HERADESIGN® Plano
<b>Структура</b>						
<b>Данни за канта</b>		 AK-01	 GK	 AK-02/5		
<b>Дебелина</b>		25 мм				
<b>Размери на профила (мм)</b>		56/42 мм, дължина 3000 мм				
<b>Система на окачване</b>		Симетричен профил за пана HERADESIGN® 25 мм Метална или дървена двойна скара за директен монтаж с винтове.				
<b>Тегло на профила</b>		0,54 кг/м				
<b>Реакция на огън</b>		Подходящи за помещения с до 90% постоянна въздушна влажност.				
<b>Влагуустойчивост</b>		За приложения, където влажността постоянно надвишава 80%, да се потърси становище по строителна физика.				
<b>Note</b>		Powder coating upon request				

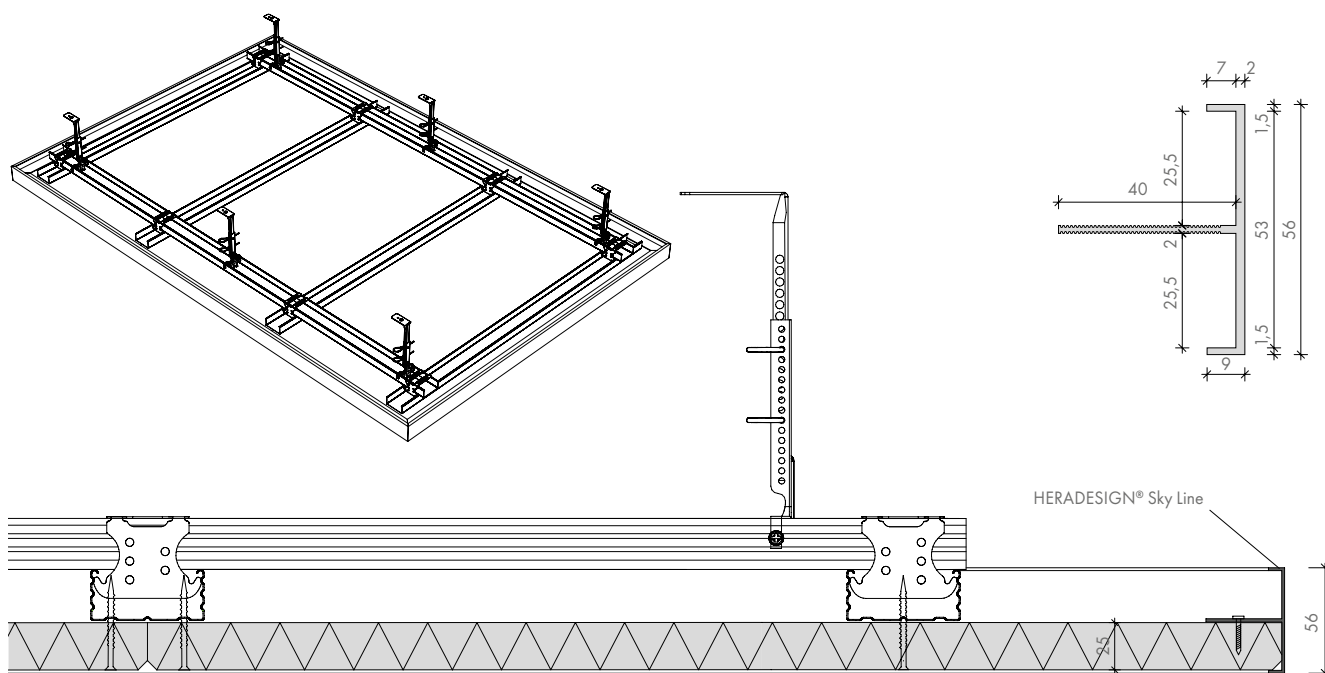

Продуктите могат да варират в различните страни. Моля свържете се с Вашия регионален представител.  
Допълнителна информация и правна рамка можете да намерите на нашия уебсайт.