

Floating Canopy Systems

HERADESIGN® Sonic Element Plus

(HERADESIGN® Sonic Element 1200x1200/2400x1200)

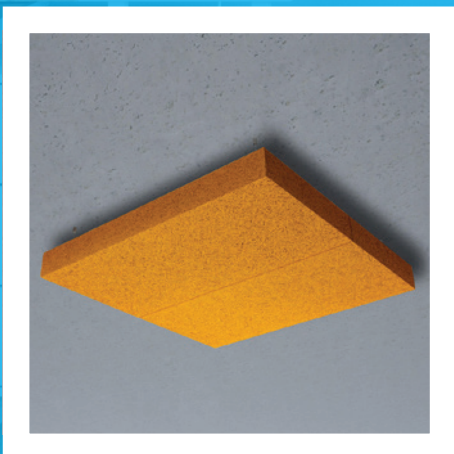











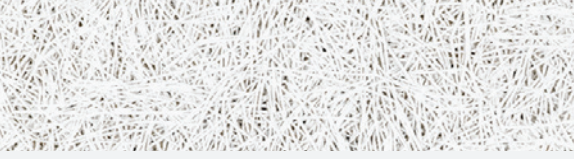











Individual



- HERADESIGN® Sonic Element Plus is an acoustic ceiling canopy with a unique HERADESIGN® Fine or HERADESIGN® Superfine surface
- Delivered as a kit making it quick and easy to install
- Available in Vario Design and RAL and NCS colours
- Ceiling canopy kit including sub-construction and suspension
- Quick and simple installation thanks to high level of pre-assembly
- HERADESIGN® Sonic Element Plus is available in 1200 x 1200 and 2400 x 1200mm dimensions
- Integrated upstand 125mm
- All required connectors and screws included
- Pre-assembled hanger with precise height adjustment

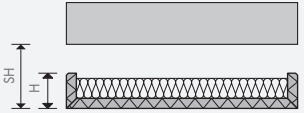

Floating Canopy Systems
HERADESIGN® Sonic Element Plus
 Individual

Surface		HERADESIGN® Fine		HERADESIGN® Superfine								
												
Edge details		 AK-01										
Thickness (mm)		25										
Dimensions (mm)		1200 x 1200 x 125 (L x W x H) 2400 x 1200 x 125 (L x W x H)										
System		Acoustic lining: 50mm fleece-lined mineral wool										
Weight		1200 x 1200: 29.2 kg/pc 2400 x 1200: 57.9 kg/pc		1200 x 1200: 27.1 kg/pc 2400 x 1200: 53.7 kg/pc								
Colours		Standard colours		vd Vario Design colours								
		 White Similar to RAL 9010	 Beige Natural tone 13									
		<ul style="list-style-type: none"> • Other colours from popular RAL and NCS colour systems are available. • Deviations in colour and visual appearance may occur due to the rough fibre and panel surface. 										
Sound absorption		Board type 1200 x 1200 x 125mm (L x W x H)										
		Product	Thickness [mm]	SH [mm]	HERADESIGN® Acoustic lining [mm]	[kg/m ²]	Equivalent absorption area Aobj [m ²] Frequencies [Hz]					
						125	250	500	1000	2000	4000	
		HERADESIGN® Superfine	25	200	50	50	0.70	1.70	2.30	2.10	2.20	2.10
		HERADESIGN® Superfine	25	400	50	50	1.00	1.70	2.20	2.30	2.50	2.40
		HERADESIGN® Superfine	25	600	50	50	1.10	1.50	2.30	2.50	2.70	2.50
		Board type 2400 x 1200 x 125mm (L x W x H)										
		HERADESIGN® Fine	25	200	50	50	1.50	3.60	4.00	3.70	4.10	3.90
		HERADESIGN® Superfine	25	200	50	50	1.40	3.70	4.30	4.40	4.30	4.80
												
Fire reaction		Euroclass B-s1,d0 according EN 13501-1										
Humidity resistance		Not suitable for use in indoor swimming pools or thermal baths										
Cleanability												
Sustainability												

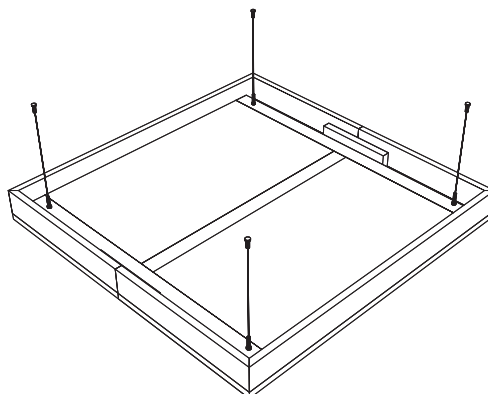

[Previous page] HERADESIGN® Sonic Element Plus (© Knauf Ceiling Solutions)

Options with this icon are available from our **Vario Design** range. Some combinations of colours and/or perforations are not available for every product. Products may vary from country to country. Please contact your local sales representative. For further information and legal notice, please visit our website. knaufceilingsolutions.com

07/2022